

Constable Executive Male and Female in Delhi Police Examination 2023

Exam Date	14/11/2023
Exam Time	9:00 AM - 10:30 AM
Subject	Constable Executive Male and Female in Delhi Police Examination 2023

Section : General Knowledge

Q.1 Which of the following stations receives the highest annual rainfall?

- Ans**
- 1. Nagpur
 - 2. Chennai
 - 3. Shillong
 - 4. Jodhpur

Q.2 Which of the following States hosted the fourth edition of the Khelo India Youth Games?

- Ans**
- 1. Assam
 - 2. Haryana
 - 3. Telangana
 - 4. Karnataka

Q.3 Siddi Dhamal is performed in which of the following states as a dance to celebrate successful hunting activity?.

- Ans**
- 1. Haryana
 - 2. Rajasthan
 - 3. Gujarat
 - 4. Punjab

Q.4 Who among the following performed religious rituals for the king during the Vedic period?

- Ans**
- 1. Purohita
 - 2. Vrajpati
 - 3. Gramani
 - 4. Senani

Q.5 National income at current prices are calculated based on _____

- Ans**
- 1. future prices
 - 2. prevailing prices
 - 3. comparative prices
 - 4. constant prices

Q.6 Who among the following Bharatnatyam dancers received the prestigious Natya Kalanidhi award in 2021?

- Ans**
- 1. Pandit Birju Maharaj
 - 2. Padma Subrahmanyam
 - 3. Chitra Visweswaran
 - 4. Guru Bipin Singh

Q.7 Which of the following is/are the goals of five year plans?

- Ans**
- 1. Growth, Modernisation, Equity and Self-reliance
 - 2. Growth, Modernisation, and Equity only
 - 3. Growth only
 - 4. Growth, and Abolition of intermediaries

Q.8 Who among the following was the Sultan of the Delhi Sultanate when the Bahmani Kingdom was established in South India?

- Ans**
- 1. Muhammad Bin Tughluq
 - 2. Ghiyasuddin Tughluq
 - 3. Nasir-ud-din Mohammed Tughluq
 - 4. Firuz Shah Tughluq

Q.9 The much-loved English novel, 'Alice's Adventures in Wonderland' was written by which of the following authors?

- Ans**
- 1. Lewis Carroll
 - 2. Herman Melville
 - 3. Mary Shelly
 - 4. Edgar Allan Poe

Q.10 Which of the following words were added in the Preamble by the Forty-second Amendment Act?

- Ans**
- 1. Justice, social
 - 2. Liberty of thought
 - 3. Fraternity assuring dignity
 - 4. Socialist, secular

Q.11 Which Article of the Indian Constitution deals with the Governor's assent to Bills?

- Ans**
- 1. Article 201
 - 2. Article 264
 - 3. Article 164
 - 4. Article 200

Q.12 Anantha R Krishnan is a famous _____ player.

- Ans**
- 1. sitar
 - 2. mridangam
 - 3. flute
 - 4. santoor

Q.13 The great poet and humanist writer Rabindra Nath Thakur returned his knighthood in protest of which incident?

- Ans**
- 1. Bengal partition, 1905
 - 2. Kamagatamaru case, 1914
 - 3. Pitt's India Act of 1784
 - 4. Jallianwala Bagh Massacre, 1919

Q.14 Ibn Battuta's book of travels, called Rihla was originally written in:

- Ans**
- 1. Urdu
 - 2. Prakrit
 - 3. Arabic
 - 4. Persian

Q.15 Annie Besant was a Fabian socialist under the influence of _____ .

- Ans
- 1. Arthur Miller
 - 2. Charles Turner
 - 3. Sigmund Freud
 - 4. George Bernard Shaw

Q.16 Which part of the food is defecated?

- Ans
- 1. Nutrients in food
 - 2. Glucose in food
 - 3. Unused food
 - 4. Vitamins in food

Q.17 It is a Fundamental Duty of parents to provide educational opportunities to wards aged _____.

- Ans
- 1. 7-14 years
 - 2. 6-14 years
 - 3. 6-16 years
 - 4. 6-15 years

Q.18 Which of the following cultural festivals is organised by the Uttar Pradesh tourism department?

- Ans
- 1. Natyanjali Utsav
 - 2. Hampi Dance Utsav
 - 3. Taj Mahotsav
 - 4. Nishagandhi Festival

Q.19 The Indian Parliament approved the 86th Constitutional Amendment Act of 2002, which establishes the fundamental right to elementary education for children aged _____.

- Ans
- 1. 6-14 Years
 - 2. 5-11 years
 - 3. 7-16 Years
 - 4. 6-17 Years

Q.20 Which of the following pairs is INCORRECT?

- Ans
- 1. Precious metal – Platinum
 - 2. Non-ferrous metal – Zinc
 - 3. Ferrous metal – Iron
 - 4. Non-metal – Lead

Q.21 According to the census of India 2011, which group of states and union territories from the following recorded the highest literacy rate?

- Ans
- 1. Kerala and Puducherry
 - 2. Kerala and Lakshadweep
 - 3. Mizoram and Delhi
 - 4. Goa and Lakshadweep

Q.22 The Pradhan Mantri Garib Kalyan Yojana (PMGKY) was launched in the year _____.

- Ans
- 1. 2015
 - 2. 2014
 - 3. 2016
 - 4. 2017

Q.23 National Waterways 10 (NW-10) is located in which state?

- Ans
- 1. Tamil Nadu
 - 2. Kerala
 - 3. West Bengal
 - 4. Maharashtra

Q.24 Which of the following is an RBI-registered NBFC- MFI that works on a Joint Liability Group lending model of Grameen?

- Ans
- 1. ESAF Microfinance and Investments (P) Ltd
 - 2. Fusion Microfinance Pvt Ltd
 - 3. Asirvad Microfinance Limited
 - 4. BSS Microfinance Limited

Q.25 Which of the following options is/are correct about cropland ecosystem?
Statement 1. Cropland is a man-made ecosystem.
Statement 2. Very less genetic diversity is found in cropland ecosystem.

- Ans
- 1. Only statement 1 correct
 - 2. Both statements 1 and 2 correct
 - 3. Only statement 2 correct
 - 4. Both statements 1 and 2 incorrect

Q.26 Prior to India, which country introduced Five-Year Plans for policy-making purposes?

- Ans
- 1. The US
 - 2. Great Britain
 - 3. The Union of Soviet Socialist Republics
 - 4. Germany

Q.27 The Great Bath in Mohenjo-Daro was excavated in which of the following areas?

- Ans
- 1. Residential complex
 - 2. Lower town
 - 3. Citadel
 - 4. House courtyard

Q.28 Which of the following Articles of the Indian Constitution is related with right to work, to education and to public assistance in certain cases?

- Ans
- 1. Article 43
 - 2. Article 42
 - 3. Article 41
 - 4. Article 44

Q.29 Who among the following founded the Forward Bloc in 1939?

- Ans
- 1. Mahatma Gandhi
 - 2. Jawaharlal Nehru
 - 3. Subhash Chandra Bose
 - 4. Chittaranjan Das

Q.30 Identify the scheme that was launched by the Prime Minister on 8 April 2015 for providing loans upto ₹10 lakh to the non-corporate, non-farm small/micro enterprises?

- Ans
- 1. Mahatma Gandhi National Rural Employment Guarantee Act
 - 2. Bharat Rojgar Yojana
 - 3. Pradhan Mantri Mudra Yojana
 - 4. Pradhan Mantri Shram Yogi Maan-dhan

Q.31 Which of the given monuments is NOT located in Karnataka?

- Ans
- 1. Palakkad Fort
 - 2. Kittur Fort
 - 3. Gol Gumbaz
 - 4. Hoysaleswara Temple

Q.32 Which of the following Indian Olympians has written the autobiography titled 'Playing to Win'?

- Ans
- 1. Lovlina Borgohain
 - 2. Saina Nehwal
 - 3. Abhinav Bindra
 - 4. Karnam Malleswari

Q.33 Which of the following is the correct match between column-A and column-B?

Column-A

- i. Producer
- ii. Primary consumer
- iii. Secondary consumer
- iv. Decomposer

Column-B

- a. Rabbit
- b. Green plants
- c. Bacteria and fungus
- d. Fox

- Ans
- 1. i-c, ii-d, iii-a, iv-b
 - 2. i-a, ii-b, iii-c, iv-d
 - 3. i-b, ii-a, iii-d, iv-c
 - 4. i-d, ii-c, iii-b, iv-a

Q.34 Which of the following is an example of subsistence crop of Uttar Pradesh?

- Ans
- 1. Wheat
 - 2. Cotton
 - 3. Jute
 - 4. Sugarcane

Q.35 When is Maha Shivaratri celebrated according to the Drik Panchang?

- Ans
- 1. Magha, Krishna Paksha, Chaturdashi
 - 2. Phalgun, Shukla Paksha, Ekadashi
 - 3. Chaitra, Shukla Paksha, Ekam
 - 4. Ashadh, Krishna Paksha, Trayodashi

Q.36 Which country hosted the IBA Women's World Boxing Championship-2023?

- Ans
- 1. India
 - 2. Pakistan
 - 3. Bangladesh
 - 4. Sri Lanka

Q.37 Who among the following was the Prime Minister when the Globalisation Policy as part of 'New Economic Policy' was introduced?

- Ans
- 1. PV Narasimha Rao
 - 2. Narendra Modi
 - 3. Atal Bihari Vajpayee
 - 4. Manmohan Singh

Q.38 Which of the following is an example of igneous rock?

- Ans
- 1. Conglomerate
 - 2. Chert
 - 3. Breccia
 - 4. Rhyolite

Q.39 Who won India's first medal at the Tokyo Olympics 2021?

- Ans
- 1. Lovlina Borgohain
 - 2. Mirabai Chanu
 - 3. Mary Kom
 - 4. PV Sindhu

Q.40 What was the name of the first dynasty that ruled over Magadh kingdom?

- Ans
- 1. Haryank dynasty
 - 2. Shishunga dynasty
 - 3. Mauryan dynasty
 - 4. Nanda dynasty

Q.41 Who among the following was known for creating fusion arts by adapting European theatrical techniques to Indian Classical dance combined with Indian folk and tribal dance?

- Ans
- 1. Uday Shankar
 - 2. Bipin Singh
 - 3. Kelucharan Mahopatra
 - 4. Vempsi Chinna Satyam

Q.42 Ustad Allah Rakha, Sabir Khan, Pandit Kishan Maharaj and Pandit Jnan Prakash Ghosh are associated with which musical instrument?

- Ans
- 1. Shehnai
 - 2. Tabla
 - 3. Violin
 - 4. Mridangam

Q.43 Through which of the following Acts does the government check restrictive trade?

- Ans
- 1. MRTP Act
 - 2. Foreign Trade Policy
 - 3. FEMA Act
 - 4. Industrial Policy Act 1991

Q.44 Bharatanatyam has originated from which of these states?

- Ans
- 1. Andhra Pradesh
 - 2. Maharashtra
 - 3. Tamil Nadu
 - 4. Telangana

Q.45 In which of the following years was the Rowlatt Act passed to suppress the political violence?

- Ans
- 1. 1924
 - 2. 1915
 - 3. 1919
 - 4. 1921

Q.46 Which Article of the Indian Constitution states that no citizen of India shall accept any title from any foreign State

- Ans**
- 1. Article 18 (2)
 - 2. Article 18 (3)
 - 3. Article 18 (4)
 - 4. Article 18 (1)

Q.47 Which of the following pairs regarding the judicial powers of the Indian President and their definition is INCORRECTLY matched?

- Ans**
- 1. Respite – It denotes awarding a lesser sentence in place of that which was originally awarded
 - 2. Pardon – it removes both the sentences and the conviction
 - 3. Commutation – It denotes the substitution of one form of punishment for a lighter form
 - 4. Reprieve – It implies reducing the period of sentence without changing its character

Q.48 The 'paw' is associated with which of the following games?

- Ans**
- 1. Badminton
 - 2. Chess
 - 3. Tennis
 - 4. Cricket

Q.49 Who summons each house of State Legislature to meet from time to time?

- Ans**
- 1. Chief Minister
 - 2. Governor
 - 3. Speaker
 - 4. Deputy Speaker

Q.50 Which of the following is NOT a noble gas?

- Ans**
- 1. Nitrogen (N)
 - 2. Argon (Ar)
 - 3. Helium (He)
 - 4. Neon (Ne)

Section : Reasoning

Prepare 50% Faster

Q.1 Which of the following option figures will complete the pattern in the figure given below?



Ans

1.



2.



3.



4.



Q.2 Select the correct combination of mathematical signs to sequentially replace the * signs and to balance the given equation.
 $242 * 11 * 76 * 34 * 2 * 32$

Ans 1. $++--=×$

2. $+++--=×$

3. $+-+×=$

4. $++-×=$

Q.3 Select the set in which the numbers are related in the same way as are the numbers of the following sets.
 (NOTE : Operations should be performed on the whole numbers, without breaking down the numbers into its constituent digits. E.g. 13 – Operations on 13 such as adding/deleting/multiplying etc. to 13 can be performed. Breaking down 13 into 1 and 3 and then performing mathematical operations on 1 and 3 is NOT allowed)
 (40, 253, 17)
 (30, 187, 13)

Ans 1. (17, 77, 9)

2. (40, 240, 20)

3. (25, 100, 15)

4. (50, 385, 15)

Q.4 Select the figure from the given options that will replace the question mark (?) in the figure given below and complete the pattern.

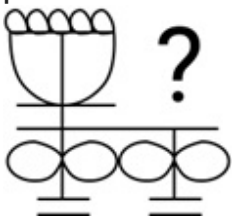

Ans

X 1.

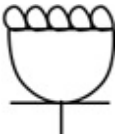

X 2.



✓ 3.



X 4.



Q.5 Given below is a series of figures – A, B, C and D which follow a particular pattern. Which of the given option figures should come in place of E to continue the series?

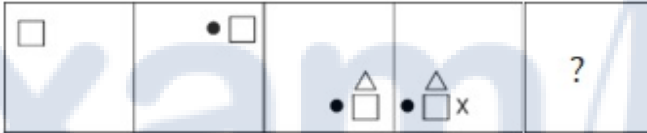

(A)

(B)

(C)

(D)

(E)

Ans

✓ 1.

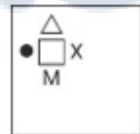

X 2.

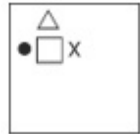

X 3.

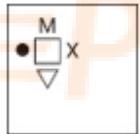

X 4.

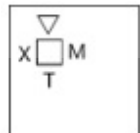

Q.6 Select the figure that will come next in the following figure series.

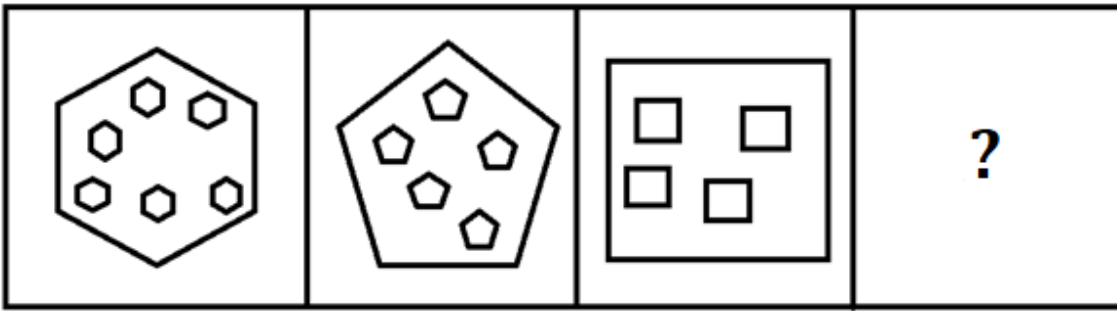

Ans

✗ 1.



✗ 2.



✓ 3.

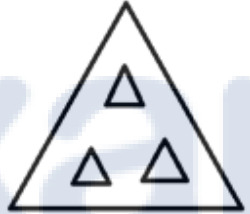

✗ 4.

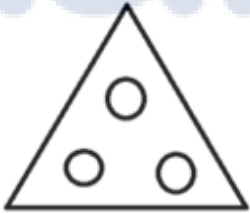

Q.7 Select the correct mirror image of the given figure when the mirror is placed at 'AB' as shown.

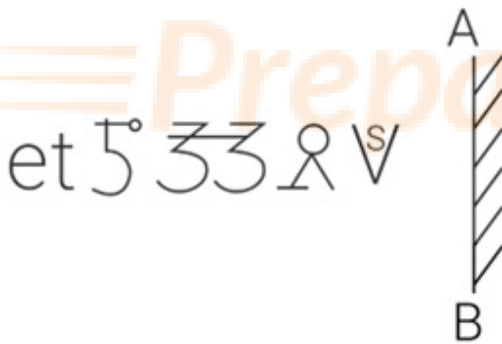

Ans

✓ 1.



✗ 2.



✗ 3.



✗ 4.



Q.8 Select the correct combination of mathematical signs to sequentially replace the * signs and to balance the given
 $198 * 11 * 18 * 20 * 50 * 294$

- Ans
- 1. $\div, \times, +, -, =$
 - 2. $\div, \times, -, +, =$
 - 3. $\div, +, \times, -, =$
 - 4. $\div, \times, =, +, -$

Q.9 C, D, E, F, M and N are sitting around a circular table facing the centre. D sits second to the right of M. F sits to the immediate left of N. N is not an immediate neighbour of M. C is not an immediate neighbour of D. Who among the following is an immediate neighbour of E?

- Ans
- 1. C
 - 2. N
 - 3. D
 - 4. F

Q.10 In a certain code language, 'CALIBER' is written as 'ECNGDGT' and 'BURNING' is written as 'DWTLKPI'. How will 'AUCTION' be written in that language?

- Ans
- 1. CWERKQP
 - 2. BWDSKPR
 - 3. BVERQKST
 - 4. CVBTKQR



Prepare 50% Faster

Q.11 Select the option figure that will replace the question mark (?) in the figure given below to complete the pattern.

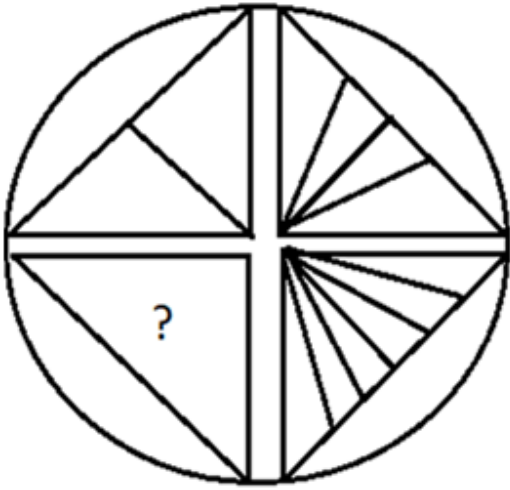

Ans

✗ 1.

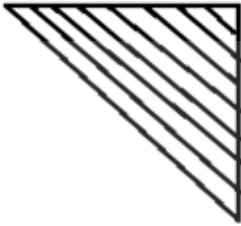

✗ 2.

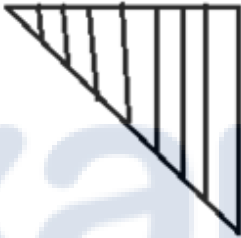

✗ 3.

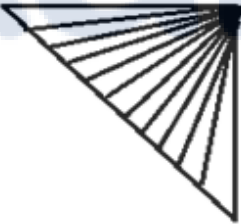

✓ 4.

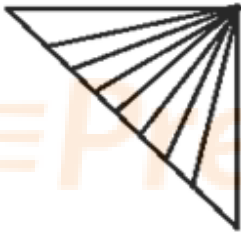

Q.12 Which of the following option figures will complete the pattern in the figure given below?



Ans



Q.13 How many triangles are there in the given figure?

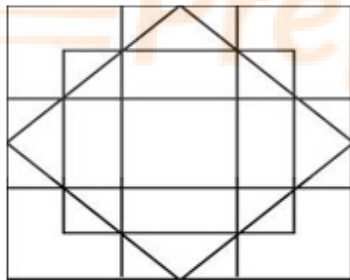

- Ans
- ✗ 1. 20
 - ✓ 2. 28
 - ✗ 3. 32
 - ✗ 4. 24

Q.14 Which of the following terms will replace the question mark (?) in the given series?
KYIB, IUKF, GQMJ, ?, CIQR

- Ans
- ✗ 1. HNON
 - ✗ 2. HMNO
 - ✗ 3. ENOM
 - ✓ 4. EMON

Q.15 Which of the following options will replace the question mark (?) in the given series?
9000, 7200, 5760, ?, 3686.4

- Ans
- 1. 3456
 - 2. 3860
 - 3. 4600
 - 4. 4608

Q.16 Select the correct mirror image of the given combination when the mirror is placed at 'XY' as shown below.



- Ans
- 1. D Q Z 6 5 I N A
 - 2. A N I 2 e s o D
 - 3. D Q Z 9 S I N A
 - 4. D Q Z e s I N A

Q.17 A square sheet of paper is folded along the dotted line successively along the directions shown and is then punched in the last. How would the paper look when unfolded?

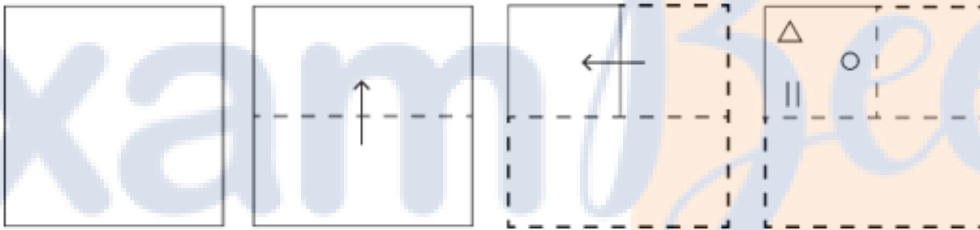

Ans

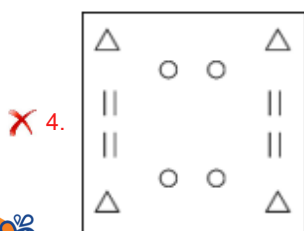
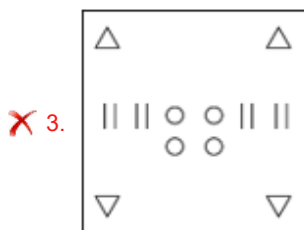
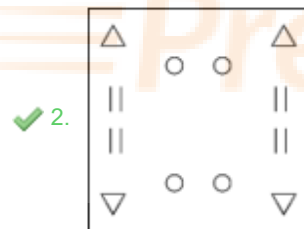
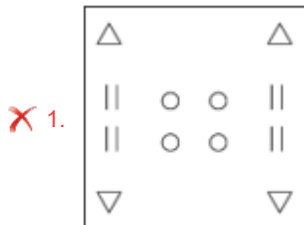

Q.18 Select the option that is related to the third word in the same way as the second word is related to the first word. (The words must be considered as meaningful English words and must not be related to each other based on the letters/number of consonants/vowels in the word)

Virus : Influenza :: Fungus : ?

- Ans
- ✓ 1. Aspergillosis
 - ✗ 2. Amaltas
 - ✗ 3. Algae
 - ✗ 4. Bacteria

Q.19 Which figure should replace the question mark (?) if the following series were to be continued?

L D 3 A	B L D R	= □ L D	A = □ R	3 S = □	
S	A	B	D	A	?
B = □ R	= □ 3 S	A 3 S R	3 S L B	D L B R	

- Ans
- ✗ 1.

S = B R
□
3 D L A
 - ✗ 2.

D 3 S =
□
L B R A
 - ✗ 3.

= 3 S A
□
B D L R
 - ✓ 4.

D 3 S R
□
L B = A

Q.20 Select the option that is related to the fourth term in the same way as the first term is related to the second term and the fifth term is related to the sixth term.
7 : 46 :: ? : 78 :: 11 : 118

- Ans
- ✗ 1. 11
 - ✗ 2. 10
 - ✓ 3. 9
 - ✗ 4. 13

Q.21 Select the figure from the given options that will replace the question mark (?) in the figure given below to complete the pattern.

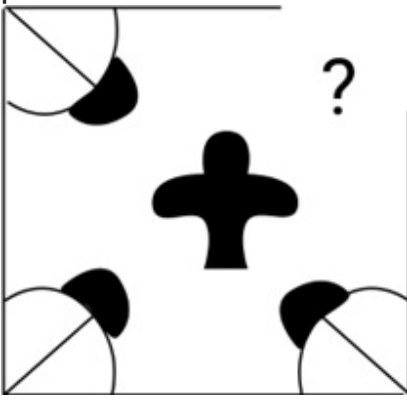

Ans

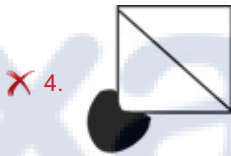
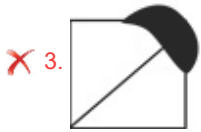
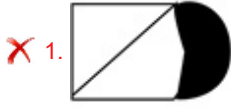

ixamBee

Prepare 50% Faster

Q.22 Which of the following option figures will complete the pattern in the figure given below?



Ans



Q.23 Six numbers, 7, 8, 9, 10, 11 and 12 are written on different faces of a dice. Three positions of this dice are shown here. Find the number on the face opposite 12.

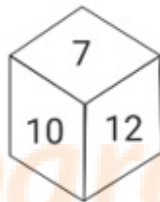
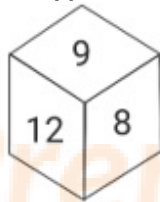
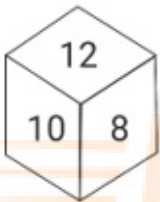

- Ans
- ✗ 1. 8
 - ✗ 2. 10
 - ✓ 3. 11
 - ✗ 4. 9

Q.24

Select the figure from the options that can replace the question mark (?) and complete the given pattern.

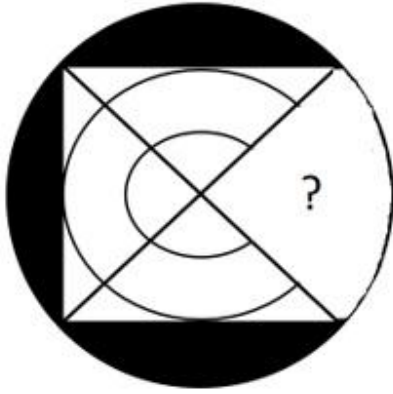

Ans

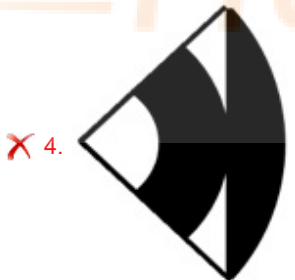
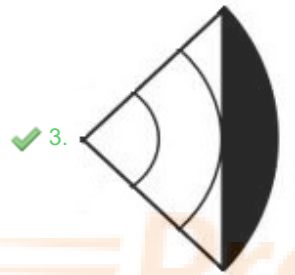
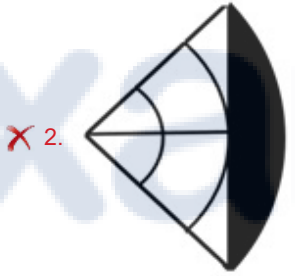
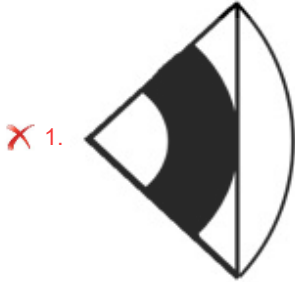

Q.25 Read the given statements and conclusions carefully. Assuming that the information given in the statements is true and it appears to be at variance with commonly known facts, decide which of the given conclusions logically follow(s) from the statements.

Statements:

Some roses are lilies.

Some lilies are jasmine.

Conclusions:

I. Some jasmines are roses.

II. All jasmines are roses.

- Ans**
- 1. Neither conclusion I nor II follows
 - 2. Only conclusion II follows
 - 3. Both conclusions I and II follow
 - 4. Only conclusion I follows

Section : Numerical Ability

Q.1 In a 600 m race, A gave B a head start of 5 seconds and still won the race by 20 seconds. If the ratio of the speed of A to the speed of B is 2 : 1, then the speed of B is:

- Ans**
- 1. 12 m/sec
 - 2. 21 m/sec
 - 3. 10 m/sec
 - 4. 18 m/sec

Q.2 A man borrowed a sum of money and agreed to pay off by paying ₹4,200 at the end of the first year and ₹4,410 at the end of the second year. If the rate of compound interest was 5% per annum, find the sum borrowed.

- Ans**
- 1. ₹7,500
 - 2. ₹8,000
 - 3. ₹8,500
 - 4. ₹7,000

Q.3 A, B, C work one after the other in that order. Each can finish a work individually in 10, 16, 12 days, respectively. After working for 3 such cycles ABC, ABC, ABC, then A and C leave the work. B alone will complete the rest of the work in:

- Ans**
- 1. $4\frac{1}{5}$ days
 - 2. $5\frac{1}{4}$ days
 - 3. $1\frac{4}{5}$ days
 - 4. $5\frac{4}{5}$ days

Q.4 The product of the LCM and HCF of two numbers is 48. The difference between the two numbers is 13. Find the numbers.

- Ans**
- 1. 6 and 19
 - 2. 9 and 22
 - 3. 10 and 23
 - 4. 3 and 16

Q.5 The slant height of a cone is 5 cm and its diameter is 8 cm. What is the volume of the cone (correct to two decimal places)? (Where $\pi = \frac{22}{7}$)

- Ans**
- 1. 59.82 cm^3
 - 2. 50.28 cm^3
 - 3. 35.66 cm^3
 - 4. 28.28 cm^3

Q.6 The simple interest on a sum of ₹1,500 at 5% p.a. for 3 years is:

- Ans
- 1. ₹180
 - 2. ₹195
 - 3. ₹192
 - 4. ₹225

Q.7 What is the unit digit of the product of all the prime numbers between 51 and 78?

- Ans
- 1. 6
 - 2. 7
 - 3. 2
 - 4. 3

Q.8 By what percentage should a woman increase the speed of her car to reduce the time by 80% to cover a fixed distance?

- Ans
- 1. 300%
 - 2. 400%
 - 3. 200%
 - 4. 100%

Q.9 An ice cream cone is to be made to have volume $\frac{128}{3}\pi$ and the height of the cone is double the radius of the cone. What is the slant height of the cone?

- Ans
- 1. $\sqrt{60}$
 - 2. $\sqrt{40}$
 - 3. $\sqrt{90}$
 - 4. $\sqrt{80}$

Q.10 There are 50 students in a class. The average marks of 20 students is 70 and the remaining 30 have average marks of 80. Calculate the average score of the whole class.

- Ans
- 1. 76
 - 2. 70
 - 3. 75
 - 4. 74

Q.11 If a box was sold at a loss of ₹350 for ₹4,650, then the percentage loss is equal to:

- Ans
- 1. 5%
 - 2. 8%
 - 3. 7%
 - 4. 6%

Q.12 Let $x = 5, y = 8$. Arrange the following numbers in ascending order.

$$\frac{x+1}{y-1}, \frac{2x}{2y-3}, \frac{y+1}{2x-1}, \frac{y+1}{3x-y}$$

- Ans
- 1. $\frac{x+1}{y-1}, \frac{2x}{2y-3}, \frac{y+1}{2x-1}, \frac{y+1}{3x-y}$
 - 2. $\frac{2x}{2y-3}, \frac{x+1}{y-1}, \frac{y+1}{3x-y}, \frac{y+1}{2x-1}$
 - 3. $\frac{2x}{2y-3}, \frac{x+1}{y-1}, \frac{y+1}{2x-1}, \frac{y+1}{3x-y}$
 - 4. $\frac{2x}{2y-3}, \frac{y+1}{2x-1}, \frac{x+1}{y-1}, \frac{y+1}{3x-y}$

Q.13 Which of the following is a pair of co-primes?

- Ans
- 1. (198, 175)
 - 2. (7, 35)
 - 3. (217, 651)
 - 4. (32, 62)

Q.14 After a 15% decline, the income of Ajay stands at ₹2,12,500. What was his original income (in ₹)?

- Ans
- 1. 2,25,000
 - 2. 1,80,625
 - 3. 2,50,000
 - 4. 2,40,000

Q.15 A shopkeeper marks an article 35% above the cost price, and offers 20% discount on the marked price, what is his gain percentage?

- Ans
- 1. 7%
 - 2. 8%
 - 3. 9%
 - 4. 5%

Section : Computer Proficiency

Q.1 Which of the following operations is done using shortcut key Ctrl + Shift + > in MS Word 365?

- Ans
- 1. Left Alignment of text
 - 2. Decrease the font size
 - 3. Right Alignment of text
 - 4. Increase the font size

Q.2 An attachment in an E-mail can be:

- 1) Digital photos
- 2) Documents

- Ans
- 1. Only (1)
 - 2. Neither (1) nor (2)
 - 3. Only (2)
 - 4. Both (1) and (2)

Q.3 Which formatting feature in MS Word 365, is used to emphasise text by making it bold, italic or underlined in doc

- Ans**
- 1. Hyperlinking
 - 2. Text wrapping
 - 3. Page margins
 - 4. Font styling

Q.4 Which of the following is NOT a layer of the Internet Protocol Suite (TCP/IP)?

- Ans**
- 1. Transport layer
 - 2. Physical layer
 - 3. Application layer
 - 4. Network layer

Q.5 In MS Excel 365, you are working on an Excel worksheet and need to select an entire row above the current row. Which keyboard shortcut combination should you use?

- Ans**
- 1. Alt + Spacebar
 - 2. Ctrl + +
 - 3. Shift + Spacebar
 - 4. Ctrl + Spacebar

Q.6 In MS Word 365, what happens when you select text and then press the 'Backspace' key?

- Ans**
- 1. The text is copied to the clipboard
 - 2. The text is moved to the end of the document
 - 3. The text is formatted with a bold style
 - 4. The text is deleted to the left of the cursor

Q.7 What is the default print range in Microsoft Excel 365, when printing an entire worksheet?

- Ans**
- 1. Selected Range
 - 2. Entire Workbook
 - 3. All Sheets
 - 4. Active Sheet

Q.8 In MS-Word 2010, Page number option comes under which of the following menus?

- Ans**
- 1. Pages
 - 2. Header and Footer
 - 3. Home Tab
 - 4. Page layout

Q.9 Which option allows you to adjust the line spacing between lines of text in a paragraph in MS-Word 365?

- Ans**
- 1. Paragraph Alignment
 - 2. Line Spacing
 - 3. Paragraph Border
 - 4. Text Indentation

Q.10 In MS Excel 365, when entering data into an MS Excel 365 spreadsheet, which data type is most suitable for a person's first name?

- Ans**
- 1. Text
 - 2. Date
 - 3. Currency
 - 4. Number

Constable Executive Male and Female in Delhi Police Examination 2023

Exam Date	14/11/2023
Exam Time	12:00 PM - 1:30 PM
Subject	Constable Executive Male and Female in Delhi Police Examination 2023

Section : General Knowledge

Q.1 In India, which mode of transport provide door to door services?

- Ans**
- 1. Railways
 - 2. Waterways
 - 3. Road transport
 - 4. Airways

Q.2 In which year did India adopt a dual exchange rate for the interim period?

- Ans**
- 1. 1992
 - 2. 1994
 - 3. 1996
 - 4. 1990

Q.3 The Katakhal, Jiri, Chiri, Modhura, Longai, Sonai, Rukni and Singla are the main tributaries of which river?

- Ans**
- 1. Damodar
 - 2. Ghaghra
 - 3. Chambal
 - 4. Barak

Q.4 A novel based on the story of a family named 'Fasting, Feasting' was written by whom among the following?

- Ans**
- 1. Arvind Adiga
 - 2. Anita Desai
 - 3. Kiran Desai
 - 4. Arundhati Roy

Q.5 The period between two FIFA Football World Cups is _____.

- Ans**
- 1. 5 years
 - 2. 6 years
 - 3. 4 years
 - 4. 3 years

Q.6 The famous south Indian epic "Silappadikaram" was originally written in _____ language.

- Ans**
- 1. Malayalam
 - 2. Telugu
 - 3. Tamil
 - 4. Sanskrit

Q.7 What is the slogan of the Pradhan Mantri Jan Dhan Yojana?

- Ans**
- 1. Mera Khaata, Bhagya Vidhaata
 - 2. MeraAdhikar, MeraKhaata
 - 3. MeraKhaata, MeraAdhikar
 - 4. Mera Paisa, Mere Bank Me

Q.8 Article 39A of the Constitution of India gives the idea of:

- Ans**
- 1. right to work, to education and to public assistance in certain cases
 - 2. equal justice and free legal aid
 - 3. provisions for just and humane conditions of work
 - 4. living wage, etc., for workers

Q.9 The first battle of Panipat was fought between Babur and _____ .

- Ans**
- 1. Muhammad bin Tughlaq
 - 2. Ibrahim Lodhi
 - 3. Sikandar Lodhi
 - 4. Maharana Pratap

Q.10 The Begumpuri mosque was built during the reign of Sultan _____ .

- Ans**
- 1. Qutbuddin Aybak
 - 2. Muhammad Bin Tughluq
 - 3. Jalaluddin Khalji
 - 4. Ghiyasuddin Balban

Q.11 Who was defeated by Chandragupta Maurya in order to found the Maurya dynasty?

- Ans**
- 1. Mahapadma Nanda
 - 2. Bimbisara
 - 3. Dhana Nanda.
 - 4. Ajatshatru

Q.12 Which of the following ministries collaborated with NCERT on a joint mission for the NISHTHA capacity-building programme for Eklavya school teachers and principals?

- Ans**
- 1. Ministry of Tribal Affairs
 - 2. Ministry of Minority Affairs
 - 3. Ministry of Education
 - 4. Ministry of Skill Development and Entrepreneurship

Q.13 Ram Sahay Panday got Padma Shri for promoting the dance form "Raai" from Bundelkhand region. Which State does this dance form belong to?

- Ans**
- 1. Madhya Pradesh
 - 2. Chhattisgarh
 - 3. Rajasthan
 - 4. Bihar

Q.14 Which of the following dances of South India is known as peacock dance?

- Ans**
- 1. Garadi
 - 2. Mayilattam
 - 3. Padayani
 - 4. Kummi

Q.15 R Muthukannammal was conferred the Padma Shri award in 2022. Which of the following is her contribution?

- Ans
- 1. Being a custodian of the early dance form of Bharatnatyam
 - 2. Specializing in the study of Indian society
 - 3. Working with Orissa's poor and backward communities
 - 4. Playing a key role in powering India's Blue Revolution

Q.16 Autotrophs can fix _____.

- Ans
- 1. carbon monoxide
 - 2. carbon dioxides
 - 3. oxygen
 - 4. methane

Q.17 In a volleyball game, 'libero' is a _____.

- Ans
- 1. specialised attacking player
 - 2. specialised defensive player
 - 3. smashing expert
 - 4. blocking expert

Q.18 Which of the following statements about Indian river systems is correct?

- Ans
- 1. The Mahanadi river flows through the state of Chhattisgarh only.
 - 2. Sone River originates in Punjab.
 - 3. Godavari river flows through Haryana state.
 - 4. Yamuna River is a tributary of Ganga River.

Q.19 Which of the following statements are correct regarding festivals followed in Christianity?

- A. Easter is the day celebrated for the 'Resurrection of Jesus Christ'.
 B. According to the Bible, 'Three days after Jesus was crucified, he was resurrected'.
 C. Good Friday is to commemorate the day of crucifixion of Jesus Christ.

- Ans
- 1. B and C only
 - 2. A and B only
 - 3. A and C only
 - 4. A, B and C

Q.20 Who among the following founded the Satnami Movement in central India for the betterment of leather workers?

- Ans
- 1. BR Ambedkar
 - 2. Swami Vivekananda
 - 3. Guru Ghasidas
 - 4. Mahatma Gandhi

Q.21 How many temples and monasteries are there in Ellora caves?

- Ans
- 1. 29
 - 2. 23
 - 3. 34
 - 4. 18

Q.22 Musician Bhajan Sopori was a Santoor maestro from the _____ Gharana.

- Ans
- 1. Punjab
 - 2. Sufiana
 - 3. Benaras
 - 4. Maihar

Q.23 Reserve Bank of India (RBI) was established on:

- Ans
- 1. 1 April 1925
 - 2. 1 April 1945
 - 3. 1 April 1955
 - 4. 1 April 1935

Q.24 Jhali is the folk dance of which Indian state?

- Ans
- 1. Bihar
 - 2. Uttar Pradesh
 - 3. Madhya Pradesh
 - 4. Himachal Pradesh

Q.25 Which of the following gave the British Indian government enormous powers to repress political activities, and allowed the detention of political prisoners without trial for two years?

- Ans
- 1. Rowlatt Act
 - 2. Indian Contract Act
 - 3. Negotiable Instruments Act
 - 4. Indian Slavery Act

Q.26 The parliamentary system of the Government in India is based on the pattern of which of the following Parliamentary Governments?

- Ans
- 1. British
 - 2. Russian
 - 3. USA
 - 4. Canadian

Q.27 Kajli Teej is the cultural festival of which Indian state?

- Ans
- 1. Goa
 - 2. West Bengal
 - 3. Maharashtra
 - 4. Rajasthan

Q.28 Destruction, weathering, dissolving, rainfall, and lithification are the major geological processes that contribute to the formation of which of the following rocks?

- Ans
- 1. Metamorphic rocks
 - 2. Igneous rocks
 - 3. Sedimentary rocks
 - 4. Sub-metamorphic rocks

Q.29 What is the molecular mass of an ozone molecule?

- Ans
- 1. 18
 - 2. 32
 - 3. 16
 - 4. 48

Q.30 According to Census 2011 of India, which religion recorded highest literacy rate from following?

- Ans
- 1. Sikh
 - 2. Hindu
 - 3. Muslim
 - 4. Jain

Q.31 'Freedom is my birth right and I shall have it'. Who among the following said this?

- Ans
- 1. Bipin Chandra pal
 - 2. Lala Lajpat Rai
 - 3. Aurobindo Ghosh
 - 4. Bal Gangadhar Tilak

Q.32 Which of the following is NOT a feature of India's parliamentary government?

- Ans
- 1. Membership of the ministers in the legislature
 - 2. Presence of nominal and real executives
 - 3. Majority party rule
 - 4. Dissolution of the Rajya Sabha

Q.33 Which of the following is NOT a key player in the microfinance sector?

- Ans
- 1. Small finance banks
 - 2. Regional rural banks
 - 3. IDBI
 - 4. Commercial banks

Q.34 When was Singer and Nicolson's fluid mosaic model accepted as the foundational model for the interpretation of existing data on membrane proteins and lipids, and their dynamics?

- Ans
- 1. 1952
 - 2. 1942
 - 3. 1972
 - 4. 1982

Q.35 In whose presence does the Governor take oath or make affirmation in case of the absence of the Chief Justice of the High Court?

- Ans
- 1. Senior-most judge of High Court available
 - 2. Secretary of State Legislature
 - 3. Speaker of State legislature
 - 4. Nominated judge by President

Q.36 According to the census of India 2011, which group of states from the following recorded the highest population?

- Ans
- 1. Maharashtra and Bihar
 - 2. Tamil Nadu and Karnataka
 - 3. Bihar and West Bengal
 - 4. West Bengal and Madhya Pradesh

Q.37 Which of the following statements is true with regard to preference given in most Five-Year Plans in India?

- Ans
- 1. Investment in basic and heavy industries
 - 2. Regulation of financial sector
 - 3. Extensive Promotion of private sector entrepreneurship
 - 4. Control of prices

Q.38 Any dispute between the Government of India and one or more States or between the Government of India and any State or States comes under _____ jurisdiction of the Supreme Court of India.

- Ans
- 1. Writ
 - 2. Exclusive Original
 - 3. Advisory
 - 4. Appellate

Q.39 Pradhan Mantri Awas Yojana–Urban (PMAY-U) was launched in the year _____ by the Government of India.

- Ans
- 1. 2017
 - 2. 2019
 - 3. 2021
 - 4. 2015

Q.40 The Harappan city of Dholavira was divided into how many parts?

- Ans
- 1. 4
 - 2. 5
 - 3. 3
 - 4. 2

Q.41 Which of the following Articles of the Indian Constitution is related with provision for just and humane conditions of work and maternity relief?

- Ans
- 1. Article 42
 - 2. Article 44
 - 3. Article 45
 - 4. Article 43

Q.42 Who is the Head of the Secretariat of each house of the Parliament?

- Ans
- 1. President
 - 2. Secretary General
 - 3. Deputy Speaker
 - 4. Speaker

Q.43 Who among the following was the first President of the Indian Olympic Association (IOA)?

- Ans
- 1. Maharaja Bhupinder Singh
 - 2. Dr. AG Noehren
 - 3. Raja Bhalender Singh
 - 4. Sir Dorabji Tata

Q.44 National Investment Fund in India is a corpus fund that mobilises its financial receipts from _____.

- Ans
- 1. proceeds of profits of Central Public Sector Undertakings
 - 2. proceeds from disinvestment of Central Public Sector Undertakings
 - 3. savings of General Provident Fund
 - 4. contributory pension scheme

Q.45 Identify the crop which is grown in Rabi season in North India from the following.

- Ans
- 1. Cotton
 - 2. Gram
 - 3. Rice
 - 4. Bajra

Q.46 In 1932, the Poona Pact was signed between Mahatma Gandhi and _____.

- Ans
- 1. Dr. Babasaheb Ambedkar
 - 2. C. Natesa Mudaliar
 - 3. Taravath Madhavan Nair
 - 4. Ramaswami Naicker-Periyar

Q.47 When did India host the Asian Games for the first time?

- Ans
- 1. 1990
 - 2. 1951
 - 3. 1962
 - 4. 1954

Q.48 The Hindi novel 'Indrajal' is written by:

- Ans
- 1. Harivansh Rai Bachchan
 - 2. Jaishankar Prasad
 - 3. Namvar Singh
 - 4. Ramdhari Singh Dinkar

Q.49 Rafflesia arnoldii is famous because:

- Ans
- 1. it has the thickest trunk
 - 2. it is the tallest plant in the plant kingdom
 - 3. it has the largest leaves in the plant kingdom
 - 4. it has the largest flower in the plant kingdom

Q.50 Ajita Srivastava is a famous folk singer from _____ and she received the Padma Shri in 2022.

- Ans
- 1. Maharashtra
 - 2. Gujarat
 - 3. Uttar Pradesh
 - 4. Madhya Pradesh

Section : Reasoning

Q.1 Three different positions of the same dice are shown, the faces of which are marked with the letters A, B, C, D, E and F. Select the letter that will be on the face opposite to the face having the letter 'D'.



- Ans
- 1. A
 - 2. F
 - 3. B
 - 4. C

Q.2 Six letters A, B, C, D, E and F are written on different faces of a dice. Two different positions of this dice are shown in the figure. Select the letter that will be on the face opposite to the one having E.

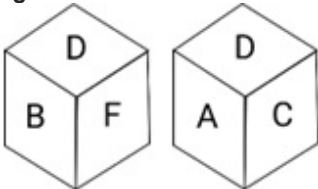

- Ans
- 1. D
 - 2. C
 - 3. A
 - 4. F

Q.3 Select the option that is related to the fourth number in the same way as the first number is related to the second and the fifth number is related to the sixth number.
 $17 : 69 :: ? : 109 :: 21 : 85$

- Ans
- 1. 31
 - 2. 37
 - 3. 40
 - 4. 27

Q.4 Three different positions of the same dice are shown. Find the number on the face opposite to the face showing '4'.

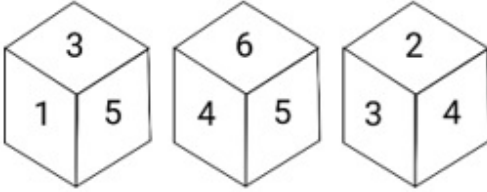

- Ans
- 1. 6
 - 2. 2
 - 3. 1
 - 4. 5

Q.5 Select the correct mirror image of the given figure when the mirror is placed at PQ as shown below.



- Ans
- 1. J S D 6 H 9
 - 2. J S D 9 H 9
 - 3. J Z D 9 H 9
 - 4. 9 H 9 D S J

Q.6 Six numbers 1, 2, 3, 4, 5 and 6 are written on different faces of a dice. Two positions of this dice are shown in the figure. Find the number on the face opposite to 2.

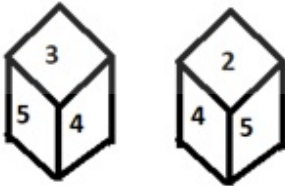

- Ans
- 1. 6
 - 2. 4
 - 3. 3
 - 4. 1

Q.7 Which two signs should be interchanged to make the given equation correct?
 $156 \div 12 - 4 \times 65 + 87 = 74$

- Ans
- 1. + and -
 - 2. + and =
 - 3. x and -
 - 4. = and x

Q.8 Select the option that is related to the fifth letter cluster in the same way as the second letter cluster is related to letter cluster and the fourth letter cluster is related to the third letter cluster.
YDVJ : PHMN :: FJBE : WNSI :: PXYS : ?

- Ans
- 1. PLEX
 - 2. GBPW
 - 3. GMNA
 - 4. JFBT

Q.9 Which figure should replace the question mark (?) if the series were to be continued?

O 8	8 =	X O	O A	
= A	O ▽	A 8	X ▽	?
X ▽	A X	= ▽	8 =	

- Ans
- 1.

= 8
O A
▽ X
 - 2.

= 8
X O
A ▽
 - 3.

= X
8 O
A ▽
 - 4.

= 8
▽ X
A O

Q.10 Six friends - A, B, C, D, E and F - were sitting around a circular table, facing the centre. They were equidistant to each other. A was sitting third to the right of B. E was to the immediate left of D. A was exactly between F and D. Who among the following was sitting third to the left of D?

- Ans
- 1. E
 - 2. F
 - 3. A
 - 4. C

Q.11 Select the number from the given options that can replace the question mark (?) in the following series.
40, 50, 30, 60, 20, ?

- Ans
- 1. 70
 - 2. 50
 - 3. 40
 - 4. 80

Q.12 Select the figure from the given options that will replace the question mark (?) in the figure given below to complete the pattern.

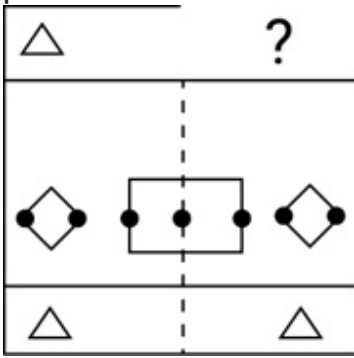

Ans

- 1.
- 2.
- 3.
- 4.

Q.13 Which of the following terms will replace the question mark (?) in the given series?
MAF, PCG, SEH, ?, YIJ

- 1. WHI
- 2. VGI
- 3. UFI
- 4. RHI

Q.14 In a certain code language, 'WAR' is written as '39' and 'ZIP' is written as '30'. How will 'YES' be written in that language?

- 1. 32
- 2. 36
- 3. 37
- 4. 34

Prepare 50% Faster

Q.15 Which figure should replace the question mark (?) in the following series to continue the pattern?

D	Z	V	□	D	V	V	□	D	=	V	D	
=				Z			Z			□		?
□				=			=			Z		

Ans

✗ 1.

D	=	V
		Z
		□

✗ 2.

D	Z	=
	V	
		□

✓ 3.

D	=	V
		□
		Z

✗ 4.

=	Z	D
	V	
		□

Q.16 Select the correct mirror image of the given figure when the mirror is placed at 'AB' as shown.

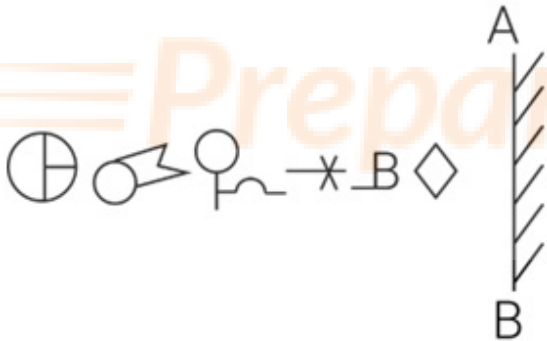

Ans

✓ 1.

✗ 2.

✗ 3.

✗ 4.

Q.17 Select the correct mirror image of the given figure when the mirror is placed at PQ as shown below.

//\|||=+&%((()\$)) |
P
Q

Ans

✗ 1. (((\$()))\°&+=//||\|\|

✗ 2. (((\$))(\°&+=||/\|\|

✓ 3. (((\$()))\°&+=||/\|\|

✗ 4. (((\$()))\°&+=||//\|



Prepare 50% Faster

Q.18

Select the option that is embedded in the given figure (rotation is NOT allowed).



Ans

✓ 1.

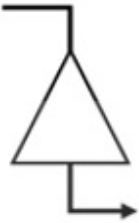

✗ 2.

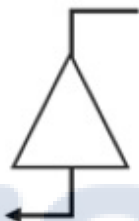

✗ 3.



✗ 4.

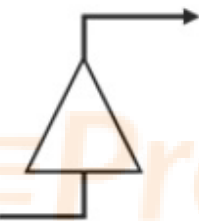

Q.19 Three numbers, 1, 2 and 3, and three letters, X, Y and Z, are written on the different faces of a dice. Two positions of this dice are shown in the given figure. Find the letter/number on the face opposite to Y.

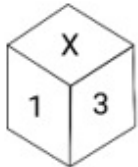

Ans

✗ 1. 3

✓ 2. 1

✗ 3. Z

✗ 4. X

Q.20 Select the correct combination of mathematical signs that can sequentially replace the * signs and balance the given expression.
 $13 * 7 * 32 * 56 * 4 * 73$

- Ans
- 1. -, ×, +, ÷, =
 - 2. -, ÷, +, ×, =
 - 3. ×, -, +, ÷, =
 - 4. +, ×, -, ÷, =

Q.21 Select the option in which the given figure is embedded (rotation is NOT allowed).



Ans

1.

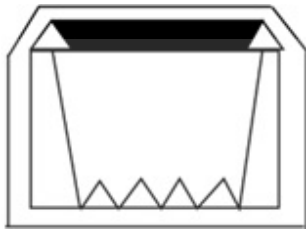

2.

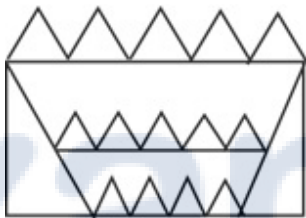

3.

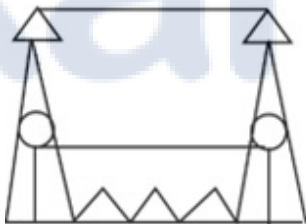

4.

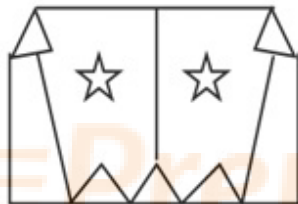

Q.22 Select the set in which the numbers are related in the same way as are the numbers of the following sets.
 (NOTE : Operations should be performed on the whole numbers, without breaking down the numbers into its constituent digits. E.g. 13 – Operations on 13 such as adding/deleting/multiplying etc. to 13 can be performed. Breaking down 13 into 1 and 3 and then performing mathematical operations on 1 and 3 is NOT allowed)
 (39, 130, 13)
 (45, 150, 15)

- Ans
- 1. (35, 125, 10)
 - 2. (25, 60, 12)
 - 3. (40, 75, 15)
 - 4. (39, 120, 17)

Q.23 Which figure should replace the question mark (?) if the following series were to be continued?

L O T R	R T = E	S R T =	= T E A	4 = T E	
=	O	E	R	A	?
M A D E	L D A M	O L D A	S D L O	R S D L	

Ans

✗ 1.

E T A 4
=
L R S D

✗ 2.

R T A 4
=
L D S E

✓ 3.

E T A L
=
4 D S R

✗ 4.

L 4 = T
E
A R S D

Q.24 How many triangles are there in the given figure?

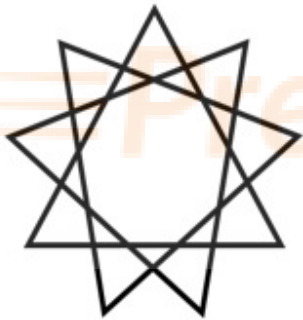

- Ans
- ✗ 1. 28
 - ✓ 2. 30
 - ✗ 3. 24
 - ✗ 4. 32

Q.25 Read the given statements and conclusions carefully. Assuming that the information given in the statements is true and it appears to be at variance with commonly known facts, decide which of the given conclusions logically follow(s) from the statements.

Statements:

Some shoes are shirts.

All shirts are jackets.

Conclusions:

I. Some shoes are jackets.

II. All jackets are shoes.

Ans 1. Neither conclusion I nor II follows

2. Only conclusion I follows

3. Both conclusions I and II follow

4. Only conclusion II follows

Section : Numerical Ability

Q.1 A, B and C can complete a piece of work in 8, 10 and 12 days, respectively. In how many days would all of them complete the same work, working together?

Ans 1. $\frac{120}{37}$ days

2. $\frac{123}{37}$ days

3. $\frac{130}{37}$ days

4. $\frac{128}{37}$ days

Q.2 If the price of tea goes up by 28%, then by what percentage (correct to the nearest whole number) should its consumption be reduced so that the expenditure on it remains unchanged?

Ans 1. 28%

2. 21%

3. 22%

4. 27%

Q.3 A trip to a destination is made in the following way:

- a) 550 km by train at an average speed of 55 km/h
 - b) 4500 km by plane at an average speed of 500 km/h
 - c) 400 km by boat at an average speed of 25 km/h
 - d) 55 km by auto at an average speed of 35 km/h
- What is the average speed for the entire journey?

Ans 1. 3300 km/h

2. 9600 km/h

3. $121 \frac{64}{25}$ km/h

4. $150 \frac{135}{256}$ km/h

Q.4 A person borrows ₹5,000 for 2 years at 4% p.a. simple interest. He immediately lends it to another person at $\frac{25}{4}$ % p.a. for 2 years. Find his gain (in ₹) in the transaction.

Ans 1. 225

2. 275

3. 200

4. 250

Q.5 Arun bought 150 guavas for ₹525 and sold them at the rate of ₹36 per dozen. What is the profit or loss percentage (correct up to two decimal places)?

- Ans**
- 1. 14.29% Loss
 - 2. 14.29% Profit
 - 3. 16.67% Loss
 - 4. 16.67% Profit

Q.6 What is the product of the 5th prime number and the prime number immediately greater than 100?

- Ans**
- 1. 1067
 - 2. 1261
 - 3. 1111
 - 4. 1717

Q.7 If marked price is 75% more than the cost price and a discount of 40% is allowed on the marked price, then percentage profit is:

- Ans**
- 1. 8%
 - 2. 7%
 - 3. 3%
 - 4. 5%

Q.8 If 45% of Ram's money is added to 50% of Soham's money, then the total amount will be 86% of Soham's money. What percentage of Ram's money did Soham have?

- Ans**
- 1. 95%
 - 2. 85%
 - 3. 137%
 - 4. 125%

Q.9 A vertical pole of length 8.3 m casts a shadow of length 4.15 m. Find the height of the tree that casts a 40 m long shadow under similar conditions (in m).

- Ans**
- 1. 70
 - 2. 80
 - 3. 100
 - 4. 60

Q.10 What is the value of $\frac{0.061 \times 0.061 \times 0.061 + 0.031 \times 0.031 \times 0.031}{0.061 \times 0.061 - 0.061 \times 0.031 + 0.031 \times 0.031}$?

- Ans**
- 1. 0.27
 - 2. 0.0081
 - 3. 0.092
 - 4. 1.8

Q.11 A solid copper sphere of diameter 30 cm is drawn into a wire of diameter 10 cm. Find the length of the wire (in cm).

- Ans**
- 1. 240
 - 2. 180
 - 3. 120
 - 4. 300

Q.12 If k , $(k^2 + 3)$ and $(k^3 + 5)$ are prime numbers, then what will be the value of k ?

- Ans
- 1. 2
 - 2. 4
 - 3. 7
 - 4. 3

Q.13 The initial population of a country is 1,87,500. If the birth and the death rates are 13% and 9%, respectively, then find the population of the country after 2 years.

- Ans
- 1. 2,02,700
 - 2. 2,02,800
 - 3. 2,02,900
 - 4. 2,03,000

Q.14 Find the average of the first five composite numbers.

- Ans
- 1. 8.2
 - 2. 6.8
 - 3. 7.8
 - 4. 7.4

Q.15 What is the area of a triangle (in "cm²") having sides of length 24 cm, 17 cm and 9 cm?

- Ans
- 1. $40\sqrt{2}$
 - 2. $35\sqrt{2}$
 - 3. $20\sqrt{2}$
 - 4. $40\sqrt{3}$

Section : Computer Proficiency

Q.1 Which of the following is an example of a table style in Microsoft Word 365?

- Ans
- 1. Chicago Manual of Style
 - 2. Plain Grid
 - 3. APA (American Psychological Association)
 - 4. MLA (Modern Language Association)

Q.2 Which of the following functions in MS Excel 365 removes irregular spacing, leaving one space between each value?

- Ans
- 1. VLOOKUP
 - 2. AVERAGE
 - 3. TRIM
 - 4. SUM

Q.3 Which of the following is the foundation of data communication on the web, enabling the transfer of web page content?

- Ans
- 1. Uniform Resource Locator
 - 2. Hypertext Transfer Protocol
 - 3. World Wide Web
 - 4. Domain Name Server

Q.4 In MS word 365 Which of the following options is correct?

- 1) Ctrl + X is used for copying the document
- 2) Ctrl + V is used for moving the document

- Ans
- 1. Only (2)
 - 2. Only (1)
 - 3. Neither (1) nor (2)
 - 4. Both (1) and (2)

Q.5 Which of the following shortcut keys is used in MS Excel 365 to make the cell in edit mode, allowing you to make changes?

- Ans
- 1. Ctrl + F1
 - 2. F1
 - 3. F2
 - 4. Ctrl + F2

Q.6 In MS Word 365 What is the primary purpose of using bullets and numbering in document formatting?

- Ans
- 1. To highlight text with a different font or colour.
 - 2. To organize information into lists or sequences.
 - 3. To adjust the margins and spacing of the document.
 - 4. To indicate the importance of specific text.

Q.7 In MS Excel 365, what is the term for the area that contains specific and formatted data in MS Excel for printing?

- Ans
- 1. Print area
 - 2. Print margin
 - 3. View
 - 4. Print preview

Q.8 Which of the following is a computer-based application for the exchange of messages between users?

- Ans
- 1. Mozilla
 - 2. Bing
 - 3. Chrome
 - 4. Email

Q.9 Which of the following is used to create a New Blank Document?

- Ans
- 1. MS-Word
 - 2. MS Outlook
 - 3. MS-PowerPoint
 - 4. MS-Excel

Q.10 In MS-Word 365, which of the following options allows you to change the font size of selected text to the next larger size available in the font size list?

- Ans
- 1. Italics
 - 2. Bold
 - 3. Decrease Font Size
 - 4. Increase Font Size

Constable Executive Male and Female in Delhi Police Examination 2023

Exam Date	14/11/2023
Exam Time	3:00 PM - 4:30 PM
Subject	Constable Executive Male and Female in Delhi Police Examination 2023

Section : General Knowledge

Q.1 The National Sports Festival for Women was started in ____.

- Ans**
- 1. 1970
 - 2. 1975
 - 3. 1976
 - 4. 1974

Q.2 Ashvaghosha, the author of Buddhacharita, was the philosopher in the court of which Kushana kings?

- Ans**
- 1. Kanishka I
 - 2. Vasudeva I
 - 3. Vima Kadphises
 - 4. Huvishka

Q.3 Pandit Ayodhya Prasad is associated with _____.

- Ans**
- 1. pakhawaj
 - 2. guitar
 - 3. veena
 - 4. flute

Q.4 Ram Sahay Pandey, a Padma Shri 2022 awardee, is associated with which of the following dance forms of the Bedia community of Madhya Pradesh?

- Ans**
- 1. Ravala
 - 2. Badhai
 - 3. Karma
 - 4. Rai

Q.5 The autobiography 'Long Walk to Freedom' is written by:

- Ans**
- 1. BR Ambedkar
 - 2. Nelson Mandela
 - 3. MK Gandhi
 - 4. Rabindranath Tagore

Q.6 In which language was the largest newspaper published in India in the year 2021-22?

- Ans**
- 1. Urdu
 - 2. English
 - 3. Hindi
 - 4. Bengali

Q.7 In which of the following years Cripps Mission offered Dominion Status to India?
Ans 1. 1942
 2. 1945
 3. 1934
 4. 1939

Q.8 In the Lok Sabha, _____ seats are reserved for the members from Scheduled Castes.
Ans 1. 80
 2. 73
 3. 84
 4. 82

Q.9 'Nage Waza' is a _____ technique used in judo.
Ans 1. gripping
 2. holding
 3. throwing
 4. chocking

Q.10 From which of the following countries did India adopt the 'amendment procedure in the constitution'?
Ans 1. France
 2. South Africa
 3. The US
 4. Ireland

Q.11 Which of the following options had figured in the royal emblem of the Chola dynasty?
Ans 1. Horse
 2. Tiger
 3. Fish
 4. Elephant

Q.12 In which of the following Indian states is Ghum Monastery located?
Ans 1. Himachal Pradesh
 2. Arunachal Pradesh
 3. West Bengal
 4. Karnataka

Q.13 Below are some statements about the Ozone layer.
Statement 1. It is found in the stratosphere.
Statement 2. Chlorofluorocarbons (CFCs) are responsible for Ozone hole.
Statement 3. Ozone layer is found around 15–30 km above the earth's surface.
Statement 4. Ozone layer is expected not to recover anymore now.
Which of these statements are correct?
Ans 1. Only statements 1, 2 and 3
 2. Only statements 1 and 2
 3. Only statements 3 and 4
 4. Only statements 2, 3 and 4

Q.14 The Sun Temple of Konark is located on the shore of the _____.
Ans 1. Arabian Sea
 2. Indian Ocean
 3. Bay of Bengal
 4. Red Sea

Q.15 In which of the following dance genres is Mallika Sarabhai an accomplished dancer?

- Ans
- 1. Odissi and Kuchipudi
 - 2. Kuchipudi and Bharatnatyam
 - 3. Bharatnatyam and Odissi
 - 4. Kathakali and Odissi

Q.16 The term 'monsoon' denotes the seasonal change in wind direction that occurs during which specific time period?

- Ans
- 1. Year
 - 2. Two decades
 - 3. One day
 - 4. Two months

Q.17 Who among the following social reformers established Satyashodhak Samaj?

- Ans
- 1. Ramaswami Naicker-Periyar
 - 2. Jyotiba Phule
 - 3. Narayana Guru
 - 4. Dr. Babasaheb Ambedkar

Q.18 Which of the following states topped the medal tally in the Khelo India Youth Games 2023?

- Ans
- 1. Haryana
 - 2. Maharashtra
 - 3. Uttar Pradesh
 - 4. Punjab

Q.19 Which Article of the Constitution of India empowers a High Court to issue writs?

- Ans
- 1. Article 220
 - 2. Article 230
 - 3. Article 226
 - 4. Article 223

Q.20 Vijayadashami is also known as _____.

- Ans
- 1. Ganesh Chaturthi
 - 2. Dussehra
 - 3. Holi
 - 4. Diwali

Q.21 National Food Security Mission was launched in India in the year 2007-08 to increase the production of rice, wheat and _____.

- Ans
- 1. saffron
 - 2. pulses
 - 3. fruits
 - 4. millet

Q.22 The famous festival known as 'Paro Tschechu' is associated with which country?

- Ans
- 1. Burma
 - 2. Japan
 - 3. Bhutan
 - 4. Thailand

Q.23 Hojagiri is a famous dance form of which of these states?

- Ans
- 1. Assam
 - 2. Jharkhand
 - 3. Tripura
 - 4. Punjab

Q.24 According to Census of India 2011, the growth rate of Hindu population in the decade 2001-2011 was _____.

- Ans
- 1. 16.8%
 - 2. 10.0%
 - 3. 20.1%
 - 4. 8.6%

Q.25 Which Article of the Constitution of India states that the President shall appoint judges of the Supreme Court under his hand and seal after consultation with such of the judges of the Supreme Court as the President may deem necessary?

- Ans
- 1. Article 124 (2)
 - 2. Article 142(2)
 - 3. Article 134 (2)
 - 4. Article 120 (2)

Q.26 _____ is the final interpreter of the Constitution of India.

- Ans
- 1. President of India
 - 2. Supreme Court
 - 3. Attorney General
 - 4. Comptroller and Auditor General

Q.27 The Dronacharya award is given to _____.

- Ans
- 1. best soldier
 - 2. best coach
 - 3. best player
 - 4. best teacher

Q.28 Which of the following festivals is celebrated in honour of Hidimba Devi in Himachal Pradesh?

- Ans
- 1. Bisua Festival
 - 2. Doongri Festival
 - 3. Maghi Festival
 - 4. Shorai Festival

Q.29 Which of the following statements is correct about privatisation?

Statements:

- I. It promotes economic efficiency
- II. It delimits the interference of bureaucracy
- III. It leads to market failure

- Ans
- 1. Only statement II
 - 2. Only statements I and II
 - 3. Only statement III
 - 4. Only statement I

Q.30 High Courts have the power to issue writs under which Article of the Constitution of India?

- Ans
- 1. Article 225
 - 2. Article 222
 - 3. Article 226
 - 4. Article 223

Q.31 After independence, who had complete control over the established industries?

- Ans
- 1. Private sector
 - 2. Government
 - 3. Britishers
 - 4. Foreign investors

Q.32 Which syndrome causes a fatty hump between the shoulders, a round face and pink or purple stretch marks on the skin?

- Ans
- 1. Angelman syndrome
 - 2. Cushing syndrome
 - 3. Marfan syndrome
 - 4. Down syndrome

Q.33 Which of the following was replaced by the Green Revolution?

- Ans
- 1. Use of seeds supplied by the government
 - 2. Use of inorganic manures
 - 3. Use of organic manures
 - 4. Use of groundwater for irrigation

Q.34 Which of the following measures of credit control requires a well-developed money market?

- Ans
- 1. Variable reserve ratio
 - 2. Qualitative measures
 - 3. Open market operations
 - 4. Bank rate policy

Q.35 Cashpor Micro credit is a company that does NOT operate in the most backward districts of _____.

- Ans
- 1. Bihar
 - 2. Jharkhand
 - 3. Chhattisgarh
 - 4. Telangana

Q.36 Under which Constitutional Amendment Act, was the term "Secular" added in the Preamble?

- Ans
- 1. 44th Constitutional Amendment Act
 - 2. 41st Constitutional Amendment Act
 - 3. 42nd Constitutional Amendment Act
 - 4. 43rd Constitutional Amendment Act

Q.37 Sunlight is the main source of _____.

- Ans
- 1. Vitamin C
 - 2. Vitamin B
 - 3. Vitamin D
 - 4. Vitamin A

Q.38 Which place in the north-eastern part of the northern Indian state of Himachal Pradesh is popularly known as the Cold Desert Mountains?

- Ans
- 1. Aalo Valley
 - 2. Parvati Valley
 - 3. Sangti Valley
 - 4. Spiti Valley

Q.39 What type of earthquake occurs when induced stresses around mine workings cause massive rocks to fly explosively from the mine face, creating seismic waves?

- Ans**
- 1. Collapse earthquake
 - 2. Explosion earthquake
 - 3. Tectonic earthquake
 - 4. Volcanic earthquake

Q.40 Which Indian state has got the highest literacy rate as per National Survey of India 2022?

- Ans**
- 1. Goa
 - 2. Kerala
 - 3. Maharashtra
 - 4. Karnataka

Q.41 Name the Freedom fighter who formed a clan of non-violent revolutionaries called Khudai Khidmatgars in 1929.

- Ans**
- 1. KM Ashraf
 - 2. Abbas Tayabji
 - 3. Mohammed Yasin Khan
 - 4. Khan Abdul Ghaffar Khan

Q.42 Khandesh was incorporated into the Mughal empire in which of the following years?

- Ans**
- 1. 1601
 - 2. 1598
 - 3. 1603
 - 4. 1600

Q.43 Select the personality who received the Sangeet Natak Akademi 2021 award for his/her contribution in Mohiniyattam.

- Ans**
- 1. Bijay Kumar Jena
 - 2. Neena Prasad
 - 3. Thokchom Ibemubi Devi
 - 4. Bhuvan Kumar

Q.44 'Mein Kampf' has been written by which of the following politicians?

- Ans**
- 1. Benito Mussolini
 - 2. Hirohito
 - 3. Adolf Hitler
 - 4. Clement Attlee

Q.45 In the context of globalisation, what does PPP stand for?

- Ans**
- 1. Purchasing Power Parity
 - 2. Purchase Power Parity
 - 3. Purchasing Par Parities
 - 4. Purchasing Par Parity

Q.46 In which budget was the policy of LERMS announced?

- Ans**
- 1. 1991-92
 - 2. 1990-91
 - 3. 1995-96
 - 4. 1992-93

Q.47 Who propounded the philosophy of 'One Caste, One Religion, One God for all men'?

- Ans
- 1. Shree Narayana Guru
 - 2. Savitribai Phule
 - 3. Raja Ram Mohan Roy
 - 4. Mahatma Gandhi

Q.48 According to Sangam texts, the term uzhavar means:

- Ans
- 1. teachers
 - 2. large landowners
 - 3. ordinary ploughmen
 - 4. slaves

Q.49 Pandit Hariprasad Chaurasia is a world-renowned exponent of the _____.

- Ans
- 1. Bansuri
 - 2. Sitar
 - 3. Sarod
 - 4. tabla

Q.50 Match List I (name of the periodic element) with List II (symbols of the periodic element) and select the correct code.

List I

- A. Magnesium
- B. Boron
- C. Manganese
- D. Barium

List II

- i. Mn
- ii. B
- iii. Ba
- iv. Mg

Code:	A	B	C	D
I	iv	iii	i	ii
II	i	ii	iv	iii
III	iv	i	ii	iii
IV	iv	ii	i	iii

- Ans
- 1. IV
 - 2. II
 - 3. III
 - 4. I

Section : Reasoning

Q.1 Three different positions of the same dice are shown. Find the number on the face opposite the face having '2'.

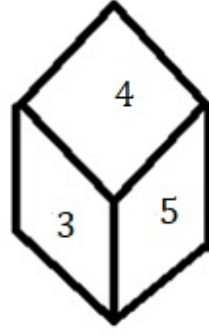
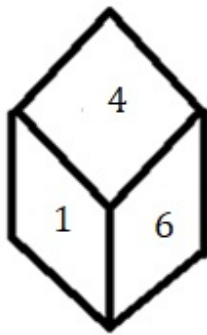
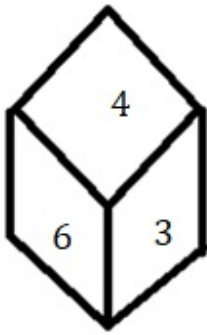

- Ans
- 1. 1
 - 2. 3
 - 3. 6
 - 4. 4

Q.2 Select the set in which the numbers are related in the same way as are the numbers of the following sets.

(NOTE: Operations should be performed on the whole numbers, without breaking down the numbers into its constituent digits. E.g. 13 – Operations on 13 such as adding/deleting/multiplying etc. to 13 can be performed. Breaking down 13 into 1 and 3 and then performing mathematical operations on 1 and 3 is not allowed)
(4, 42, 5), (3, 45, 7)

- Ans
- 1. (6, 32, 2)
 - 2. (6, 49, 3)
 - 3. (7, 42, 5)
 - 4. (7, 43, 4)

Q.3 Six students are sitting around a circular table facing the centre. Red is sitting fourth to the right of White. Blue is sitting second to the right of Gray. Black is sitting third to the right of Pink. White is the immediate neighbour of Gray and Black.. Who is the immediate neighbour of Red and Pink?

- Ans
- 1. Blue
 - 2. Gray
 - 3. Black
 - 4. White

Q.4 Four different positions of the same dice are shown below. Which number is on the face opposite to the face showing '6'?

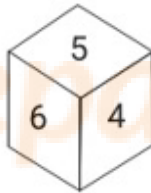
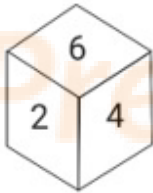
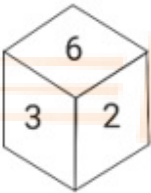

- Ans
- 1. 3
 - 2. 1
 - 3. 4
 - 4. 2

Q.5 Select the number from among the given options that can replace the question mark (?) in the following series.

1, 2, 5, 26, 677, ?

- Ans
- 1. 3255
 - 2. 24563
 - 3. 45245
 - 4. 458330

Q.6 Select the correct mirror image of the given figure when the mirror is placed at MN as shown below.



- Ans
- ✓ 1. **Z y X 7 4 8 B k**
 - ✗ 2. **k B 8 4 7 X y z**
 - ✗ 3. **k B 8 4 7 x y z**
 - ✗ 4. **Z y X 7 4 8 p k**

Q.7 Which of the following letter clusters will replace the question mark (?) in the given series to make it logically complete?
JGI, HJG, FME, DPC, ?

- Ans
- ✓ 1. **BSA**
 - ✗ 2. **BRB**
 - ✗ 3. **BSB**
 - ✗ 4. **ASA**

Q.8 Select the option that is related to the third term in the same way as the second term is related to the first term and the sixth term is related to the fifth term.
400 : 200 :: 248 : ? :: 256 : 128

- Ans
- ✗ 1. **114**
 - ✗ 2. **200**
 - ✗ 3. **148**
 - ✓ 4. **124**

Prepare 50% Faster

Q.9 Select the option figure that will replace the question mark (?) in the figure given below to complete the pattern.

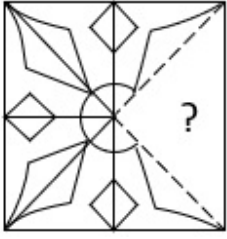

Ans

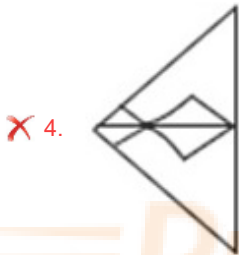
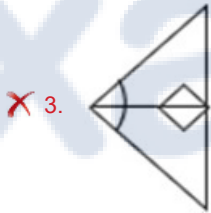
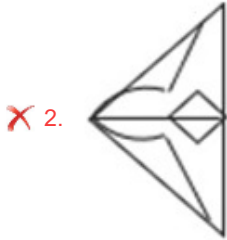
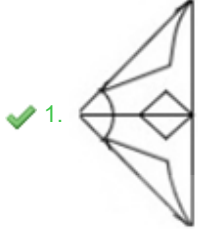

Q.10 The sequence of folding a piece of paper and the manner in which the folded paper has been cut is shown below figure which would most closely resemble the unfolded form of the paper.

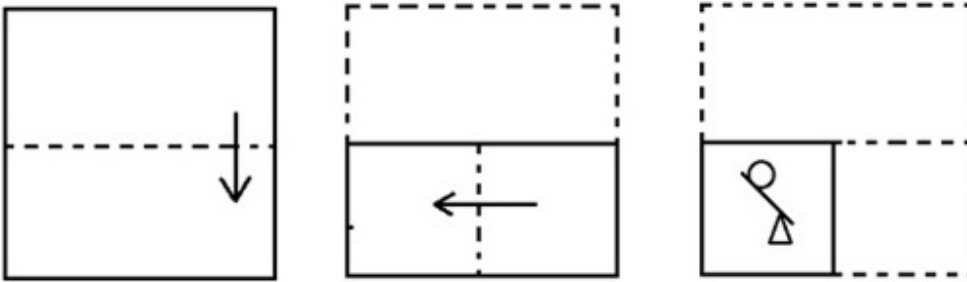

Ans

X 1.

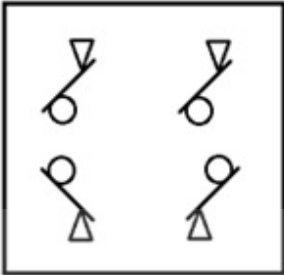

X 2.

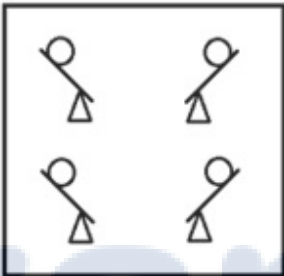

X 3.

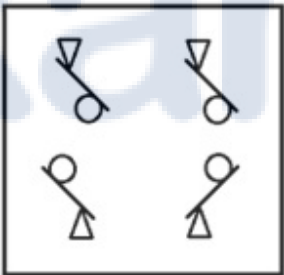

✓ 4.

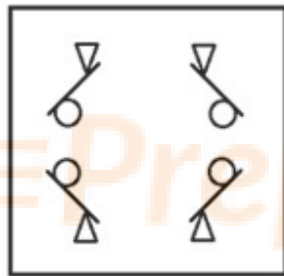

Q.11

Select the option figure that will replace the question mark (?) in the figure given below to complete the pattern.



Ans

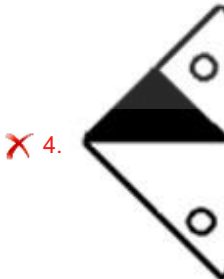
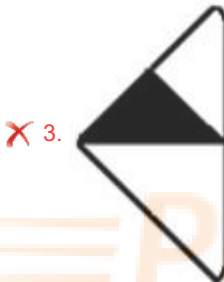
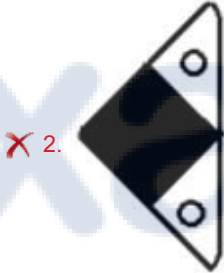
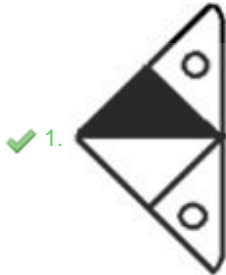

Q.12 Which of the following option figures will complete the pattern in the figure given below?



Ans

✗ 1.

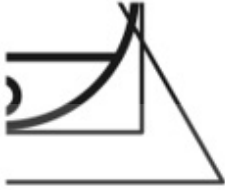

✓ 2.



✗ 3.



✗ 4.



Q.13 Six numbers, 21, 22, 23, 24, 25 and 26 are written on different faces of a dice. Three positions of this dice are shown here. Find the number on the face opposite 21.

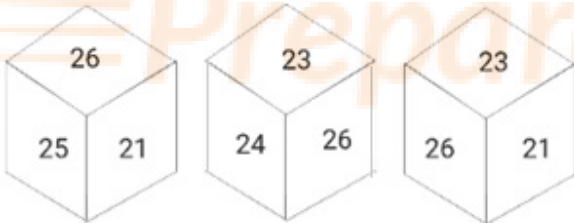

Ans

✗ 1. 23

✗ 2. 25

✓ 3. 24

✗ 4. 22

Q.14 Select the figure from the options that can replace the question mark (?) and complete the given pattern.

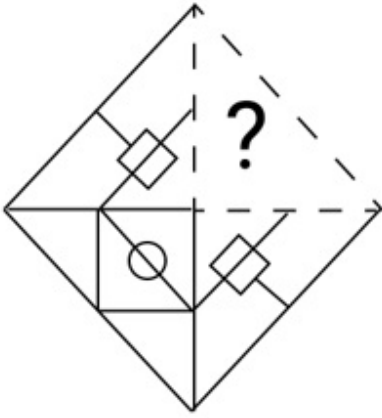

Ans

✓ 1.

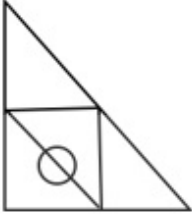

✗ 2.

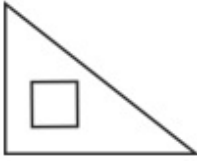

✗ 3.

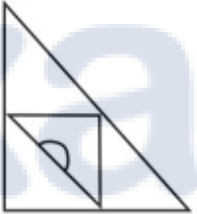

✗ 4.

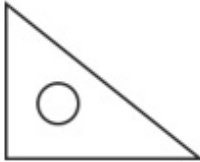

Prepare 50% Faster

Q.15 Select the figure that will replace the question mark (?) in the following figure series.

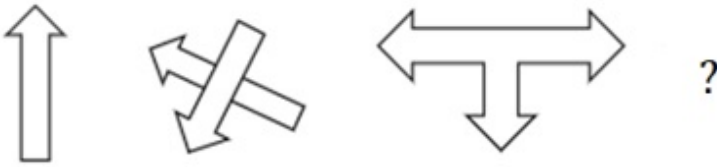

Ans

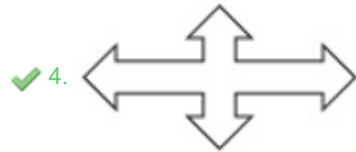
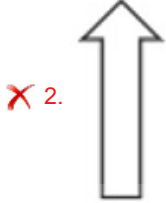

Q.16 Select the word-pair that best represents a similar relationship to the one expressed in the pair of words given below. (The words must be considered as meaningful English words and must not be related to each other based on the number of letters/number of consonants/vowels in the word.)
Exit : Leave

- Ans
- ✗ 1. Fate : Fete
 - ✓ 2. Select : Choose
 - ✗ 3. Moat : Mote
 - ✗ 4. Start : End

Q.17 Which two signs should be interchanged to make the following equation correct?

$$29 - 23 + 42 \times 21 \div 2 = 10$$

- Ans
- ✓ 1. ÷ and ×
 - ✗ 2. - and +
 - ✗ 3. + and ÷
 - ✗ 4. - and ×

Q.18 Select the correct combination of mathematical signs that can sequentially replace the * signs and balance the given equation.

$$54 * 16 * 3 * 6 * 2 * 9$$

- Ans
- ✗ 1. +, ×, -, ÷, =
 - ✗ 2. +, -, ×, ÷, =
 - ✓ 3. -, ×, +, ÷, =
 - ✗ 4. ÷, -, ×, +, =

Q.19 In a certain code language, 'BAE' is written as '512' and 'WIN' is written as '14923'. How will 'HER' be written in that language?

- Ans
- ✗ 1. 1838
 - ✗ 2. 1826
 - ✓ 3. 1844
 - 4. 1858

Q.20 How many triangles are there in the given figure?



- Ans
- 1. 8
 - 2. 5
 - 3. 6
 - 4. 7

Q.21 Three different positions of the same dice are shown. Find the number on the face opposite to the face showing '3'.

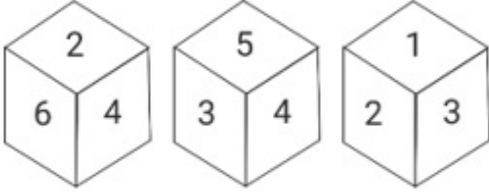

- Ans
- 1. 5
 - 2. 6
 - 3. 1
 - 4. 2

Q.22 Two statements are given followed by two conclusions numbered I and II. Assuming the statements to be true, even if they seem to be at variance from commonly known facts, decide which of the conclusions logically follow(s) from the statements.

Statements:

All Shirts are Cottons.

Some Shirts are Nets.

Conclusions:

I. All Nets are Shirts.

II. Some Nets are Cottons.

- Ans
- 1. Only conclusion II follows.
 - 2. Neither conclusion I nor II follows.
 - 3. Both conclusions I and II follow.
 - 4. Only conclusion I follows.

Q.23 Select the correct mirror image of the given figure when the mirror is placed at 'AB' as shown.

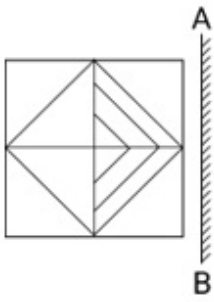

Ans

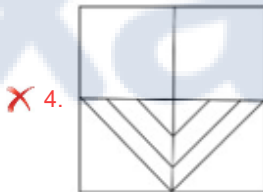
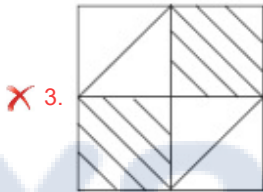
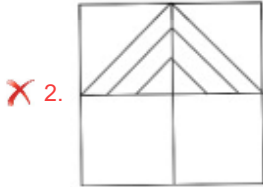
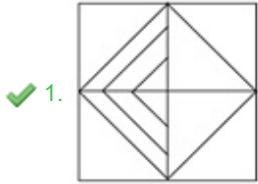

Prepare 50% Faster

Which figure from the given options would replace the question mark (?) following figure series were to be continued?

B	♥	∩	○	B	♥	○	♥	B	∩	○	♥	
○	v	8	v	8	∩	∩	v	8	v	8	B	?
∩	=	X	∩	X	=	X	=	∩	X	∩	=	

Ans

✗ 1.

∩	♥	○
8	B	=
v	X	∩

✗ 2.

○	∩	♥
X	v	8
∩	=	B

✓ 3.

∩	♥	○
X	v	8
∩	=	B

✗ 4.

v	∩	○
8	B	♥
X	=	∩

Q.25 Which figure should replace the question mark (?) if the series were to be continued?

A	U	9	9	A	U	S	9	A	A	S	9	
	S		=			□			U			?
	=		S			U			□			

Ans

✗ 1.

S	9	□
	4	
	A	

✗ 2.

□	A	S
	U	
	9	

✓ 3.

□	A	S
	4	
	9	

✗ 4.

9	□	A
	S	
	U	

Section : Numerical Ability

Q.1 A sum of ₹2,52,500 at the rate of 4.5% per annum for a period of 2.5 years will amount to how much (in ₹) if the money is invested at simple interest?

- Ans
- ✗ 1. 2,75,906.50
 - ✓ 2. 2,80,906.25
 - ✗ 3. 2,82,906.25
 - ✗ 4. 2,78,906.25

Q.2 The base of a right-angle triangle is increased by 60%. How much its height should be decreased to retain the same area?

- Ans
- ✗ 1. 45.2%
 - ✓ 2. 37.5%
 - ✗ 3. 30%
 - ✗ 4. 60%

Q.3 In an equilateral triangle, each side is 'a' units. The altitude of this triangle is:

- Ans
- ✗ 1. $\frac{4a}{3}$
 - ✗ 2. $\frac{3a^2}{4}$
 - ✓ 3. $\frac{a\sqrt{3}}{2}$
 - ✗ 4. $\frac{\sqrt{3}a}{\sqrt{2}}$

Q.4 The marked price of a book is ₹700 but the retailer gets a discount of 20%. If the retailer sells the book at marked price the profit percentage is:

- Ans
- 1. 22%
 - 2. 30%
 - 3. 25%
 - 4. 20%

Q.5 A person loses 18% of his money and after spending 87% of the remainder, he is left with ₹122. How much did he originally have? (Approximate value)

- Ans
- 1. ₹1,144.5
 - 2. ₹1,200
 - 3. ₹1,143.8
 - 4. ₹1,300

Q.6 Find the greatest number that divides 90, 180 and 240 exactly.

- Ans
- 1. 60
 - 2. 15
 - 3. 30
 - 4. 20

Q.7 The inradius of a triangle is 7 cm and its area is 343 cm^2 . The perimeter of the triangle is

- Ans
- 1. 98 cm
 - 2. 49 cm
 - 3. 68 cm
 - 4. 88 cm

Q.8 In how many seconds will a 210 m long train, travelling at a speed of 97 km/h, come from behind and completely cross a 240 m long train travelling at 79 km/h in the same direction as that of the first train?

- Ans
- 1. 84
 - 2. 96
 - 3. 90
 - 4. 100

Q.9 The average of 5 consecutive odd numbers is 63. Which of the following is the largest number among them?

- Ans
- 1. 71
 - 2. 67
 - 3. 69
 - 4. 65

Q.10 Two wires, 18 m and 24 m long, are to be cut into pieces of equal length. Find the maximum length of each piece (in m).

- Ans
- 1. 8
 - 2. 6
 - 3. 18
 - 4. 12

Q.11 The compound interest on a sum of ₹8,000 becomes ₹1,261 in 18 months. Find the rate of interest if interest is compounded half-yearly.

- Ans
- 1. 8%
 - 2. 10%
 - 3. 20%
 - 4. 12%

Q.12 A person divides his property so that his wife's share to his daughter's and the daughter's share to his son's, are ratio 1 : 4. If the wife gets ₹5,000 less than the son, the value (in ₹) of the whole property is:

- Ans**
- 1. 8,000
 - 2. 6,000
 - 3. 5,000
 - 4. 7,000

Q.13 If 4 men or 8 women can do a work in 12 days, then in how many days can 9 men and 6 women do the same work?

- Ans**
- 1. 3
 - 2. 5
 - 3. 4
 - 4. 6

Q.14 The LCM of two numbers is 12 times their HCF. One of the numbers is 8 and the sum of the HCF and LCM is 52. What is the other number?

- Ans**
- 1. 24
 - 2. 22
 - 3. 26
 - 4. 28

Q.15 The selling price of 32 items is equal to the cost price of 45 items. What is the percentage of profit made on the sale of each item?

- Ans**
- 1. 40.75%
 - 2. 40.5%
 - 3. 40.725%
 - 4. 40.625%

Section : Computer Proficiency

Q.1 Which of the following groups within the Insert tab will help us create a table in Microsoft Word 365?

- Ans**
- 1. Tables
 - 2. Illustrations
 - 3. Pages
 - 4. Links

Q.2 What is the main purpose of a search engine?

- Ans**
- 1. Playing online games
 - 2. Sending emails
 - 3. Finding information on the internet
 - 4. Editing news articles

Q.3 How do we move the cursor to the beginning of a Microsoft Word 365 document?

- Ans**
- 1. By pressing 'Ctrl + Home'
 - 2. By pressing 'Ctrl + PgDn'
 - 3. By pressing 'Ctrl + End'
 - 4. By pressing 'Ctrl + PgUp'

Q.4 In Microsoft Excel 365, which option should be selected if you want to save a workbook as a macro-enabled work with a different file name and location?

- Ans**
- 1. Save As
 - 2. Save Excel
 - 3. Save a Copy
 - 4. Save Workspace

Q.5 What are the icons below the menu bar in a word processing application called?

- Ans**
- 1. Toolbar icons
 - 2. Format icons
 - 3. Shortcut icons
 - 4. Tool icons

Q.6 Which of the following is used in MS Word 365 to change the case in a reverse way?

- Ans**
- 1. Alter case
 - 2. Toggle case
 - 3. Reverse case
 - 4. Change case

Q.7 In MS Excel 365, which of the following keyboard shortcut keys is used to insert a new row in MS-Excel 365?

- Ans**
- 1. Ctrl + shift + n
 - 2. Ctrl + shift + + (plus key)
 - 3. Ctrl + Alt + + (plus key)
 - 4. Ctrl + Alt + n

Q.8 What icon is used for attaching a file or document to an email message?

- Ans**
- 1. Paper clip icon
 - 2. Pen icon
 - 3. Smiley icon
 - 4. Trash can icon

Q.9 Which icon is commonly used to undo the last action performed in MS Word 365?

- Ans**
- 1. A trash can
 - 2. A curved arrow pointing to the left
 - 3. A pencil
 - 4. A pair of scissors

Q.10 In MS Excel 365, Which of the following is NOT a type of chart in MS Excel?

- Ans**
- 1. Pie chart
 - 2. Line chart
 - 3. Bar chart
 - 4. Space chart

Constable Executive Male and Female in Delhi Police Examination 2023

Exam Date	15/11/2023
Exam Time	9:00 AM - 10:30 AM
Subject	Constable Executive Male and Female in Delhi Police Examination 2023

Section : General Knowledge

Q.1 Arakan and Shan are recognised ethnic groups of _____.

- Ans**
- 1. Nepal
 - 2. Sri Lanka
 - 3. Myanmar
 - 4. Bhutan

Q.2 The process of removing government-imposed limits or impediments is known as:

- Ans**
- 1. globalisation
 - 2. liberalisation
 - 3. privatisation
 - 4. financial investments

Q.3 The phenomenon of liquidity trap is based upon which of the following aspects of demand for money?

- Ans**
- 1. Velocity of circulation
 - 2. Precautionary
 - 3. Speculative
 - 4. Transaction

Q.4 Who was the leader of the southern military campaign of Alauddin Khalji?

- Ans**
- 1. Malik Kafur
 - 2. Malik Sarvar
 - 3. Mahmud Ganva
 - 4. Aadham Khan

Q.5 According to Census of India, 2011 Which of the following is in the top three states with highest population of age 0-6 years?

- Ans**
- 1. Madhya Pradesh
 - 2. Maharashtra
 - 3. Kerala
 - 4. Assam

Q.6 At which Olympic Games did the Indian hockey men's team win its last gold medal?

- Ans**
- 1. 1996
 - 2. 2012
 - 3. 1980
 - 4. 2008

Q.7 The Ahaia Winter Festival is primarily organised by the North-Eastern state of _____ to promote tourism.

- Ans
- 1. Meghalaya
 - 2. Sikkim
 - 3. Arunachal Pradesh
 - 4. Tripura

Q.8 Who among the following Padma Bhushan awardee dancers was called to perform for the coronation festivities of Queen Elizabeth II?

- Ans
- 1. Kumari Kamala
 - 2. Alarmel Velli
 - 3. Yamini Krishnamurthy
 - 4. Birju Maharaj

Q.9 Select the most appropriate option with respect to the correctness of the following statements.

- a) India has great potential for the development of tidal energy.
b) A geothermal energy plant has been commissioned at Manikaran in Himachal Pradesh.

- Ans
- 1. Both a and b are incorrect
 - 2. Only b is correct
 - 3. Both a and b are correct
 - 4. Only a is correct

Q.10 The original Constitution contained 395 Articles divided into _____ parts.

- Ans
- 1. 21
 - 2. 24
 - 3. 22
 - 4. 19

Q.11 साकेवा एक धार्मिक त्योहार है जो _____ के किरात खंबू राई समुदाय द्वारा मनाया जाता है।

- Ans
- 1. पंजाब
 - 2. सिक्किम
 - 3. झारखंड
 - 4. मध्य प्रदेश

Q.12 The scheme called Bringing Green Revolution to Eastern India is being implemented in how many eastern states?

- Ans
- 1. Three
 - 2. Seven
 - 3. Four
 - 4. Six

Q.13 India announced the NEP in 1991. NEP stands for _____ .

- Ans
- 1. New Economic Provision
 - 2. New Economic Policy
 - 3. National Economic Policy
 - 4. National Export Plan

Q.14 Sandeep Das is famous for playing which of the following percussion instruments?

- Ans
- 1. Ghatam
 - 2. Pakhawaj
 - 3. Kanjira
 - 4. Tabla

Q.15 Which of the following union territories recorded the highest sex ratio at birth in India in 2020 as per annual report statistics based on Civil Registration System Report?

- Ans**
- 1. Chandigarh
 - 2. Jammu and Kashmir
 - 3. Ladakh
 - 4. Lakshadweep

Q.16 Why did Mother Teresa establish the 'Nirmal Hriday' Hospice?

- Ans**
- 1. To provide a place where the terminally ill could die in peace
 - 2. To provide a home for young widows
 - 3. To provide a refuge for patients of leprosy
 - 4. To provide a home for orphan girl-children

Q.17 In which of the following States was the 37th National Junior Athletics Championship held?

- Ans**
- 1. Nagaland
 - 2. Manipur
 - 3. Mizoram
 - 4. Assam

Q.18 A solution contains 50 g of sugar in 450 g of water. Calculate the concentration in terms of mass by mass percentage of the solution.

- Ans**
- 1. 0.01%
 - 2. 0.1%
 - 3. 10%
 - 4. 1%

Q.19 What is the sanctioned judge strength of the Supreme Court excluding Chief Justice of India as per the Supreme Court (Number of Judges) Amendment Act, 2019?

- Ans**
- 1. Twenty-One
 - 2. Twenty-Eight
 - 3. Ten
 - 4. Thirty-Three

Q.20 Freedom of Conscience provided in Article 25 of the Constitution of India is strengthened by which of the following two articles?

- Ans**
- 1. Article 27 and 29
 - 2. Article 26 and 28
 - 3. Article 27 and 28
 - 4. Article 24 and 28

Q.21 Gross national product is the total market value of all final goods and services produced by _____.

- Ans**
- 1. nationals and NRIs of a country during a period of five years
 - 2. Country's residents over a period of time
 - 3. nationals of a country during a period of five year
 - 4. national and foreigners during a period of two years

Q.22 Who among the following is known as the tabla maestro?

- Ans**
- 1. Ghulam Ali
 - 2. Ustad Amjad Ali Khan
 - 3. Ustad Bismillah Khan
 - 4. Ustad Zakir Hussain

Q.23 Which of the following dynasties arose as a result of Alexander's invasion?

- Ans
- 1. Pandya
 - 2. Pallava
 - 3. Chalukya
 - 4. Maurya

Q.24 Who among the following personalities is an award-winning Mohiniyattam Dancer?

- Ans
- 1. Vasundhara Doraswamy
 - 2. Meenakshi Chitharanjan
 - 3. Sutapa Talukdar
 - 4. Neena Prasad

Q.25 Which government scheme's main aim is to 'transform rural poor youth into an economically independent and globally relevant workforce'?

- Ans
- 1. National Career Service
 - 2. Shyama Prasad Mukherjee Rurban Mission
 - 3. Deen Dayal Upadhyaya Grameen Kaushalya Yojana
 - 4. Deendayal Antyodaya Yojana- National Rural Livelihood Mission

Q.26 In which country was the Theosophical Society founded?

- Ans
- 1. England
 - 2. America
 - 3. Japan
 - 4. France

Q.27 Which Constitutional Amendment Act has replaced the collegium system of appointing judges to the Supreme Court and High Courts?

- Ans
- 1. 65th Amendment Act
 - 2. 52nd Amendment Act
 - 3. 99th Amendment Act
 - 4. 82nd Amendment Act

Q.28 Coal, petroleum, and kerosene are examples of:

- Ans
- 1. fossil fuels
 - 2. coal fuels
 - 3. clean energy resources
 - 4. renewable resources

Q.29 According to the PRS report of the Ministry of Agriculture, which two crops contributed to 78% of the country's food grain production till 2015-16?

- Ans
- 1. Maize and soybeans
 - 2. Pulses and sugarcane
 - 3. Millets and pulses
 - 4. Wheat and rice

Q.30 Which of the following correctly describes chemotherapy?

- Ans
- 1. Use of chemicals for therapeutic purposes
 - 2. Use of physical exercise for treatment
 - 3. Use of motivational advice as treatment
 - 4. Use of treatment for behavioural disorder

Q.31 Which Constitutional Amendment Act amended Article 38, enumerated under the Directive Principles of State Policy directed 'State to minimise inequalities in income, status, facilities and opportunities'?

- Ans**
- 1. 43
 - 2. 40
 - 3. 44
 - 4. 42

Q.32 Norman Borlaug, known as the Father of Green Revolution for the world, belongs to which country?

- Ans**
- 1. US
 - 2. New Zealand
 - 3. Germany
 - 4. Australia

Q.33 The innermost sanctum of a Hindu temple where the idol of the main deity is placed is called:

- Ans**
- 1. Mandapa
 - 2. Pradakshina path
 - 3. Garbhagriha
 - 4. Shikhara

Q.34 Which special symbol is commonly used by geologists to describe the orientation of rock beds, faults, fractures, cuestas, igneous dikes and sills?

- Ans**
- 1. Average directional index
 - 2. Scale Indicator
 - 3. Compass rose
 - 4. Strike and dip

Q.35 Who led the English Forces in the Battle of Buxar?

- Ans**
- 1. Hector Munro
 - 2. Henry Lawrence
 - 3. John Nicholson
 - 4. Sir Hugh Wheeler

Q.36 Mughal officer Amil-Guzar primarily performed the task of _____.

- Ans**
- 1. gardening royal gardens
 - 2. providing safety to royal family
 - 3. recruiting soldiers
 - 4. collecting land revenue

Q.37 Which of the following Indian players has written the autobiography titled 'Ace Against Odds'?

- Ans**
- 1. Monica Seles
 - 2. Sania Mirza
 - 3. Maria Sharapova
 - 4. Saina Nehwal

Q.38 In which state of India from the following is the old bamboo drip irrigation technology still used in the agriculture?

- Ans**
- 1. Maharashtra
 - 2. Meghalaya
 - 3. Chhattisgarh
 - 4. Telangana

Q.39 Under which Article of the Indian Constitution are Fundamental Duties mentioned?

- Ans
- 1. Article 51A
 - 2. Article 55D
 - 3. Article 44C
 - 4. Article 50B

Q.40 What are the most common type of earthquakes?

- Ans
- 1. Tectonic earthquakes
 - 2. Seismic earthquakes
 - 3. Volcanic earthquakes
 - 4. Reservoir earthquakes

Q.41 Narthaki Nataraj, awarded with Padma Shri in 2019 is an Indian _____ dancer.

- Ans
- 1. Bharatanatyam
 - 2. Kathak
 - 3. Kathakali
 - 4. Odissi

Q.42 Which of the following parts/structures is located at the topmost part of a Stupa?

- Ans
- 1. Vedika
 - 2. Medhi
 - 3. Torana
 - 4. Harmika

Q.43 'Shaka' is the Indian term used for the people called Scythians, who originally belonged to _____ .

- Ans
- 1. eastern Asia
 - 2. south-western Asia
 - 3. south-eastern Asia
 - 4. central Asia

Q.44 Which of the following countries hosts the first para Asiad?

- Ans
- 1. China
 - 2. Japan
 - 3. India
 - 4. South Korea

Q.45 The Article 350 (B) of the Indian Constitution deals with the .

- Ans
- 1. finance commission
 - 2. election commission
 - 3. special officer for linguistic minorities
 - 4. UPSC

Q.46 How many medals did India win in the International Shooting Sport Federation (ISSF) World Cup-2022, which was held in Cairo, Egypt?

- Ans
- 1. 6
 - 2. 5
 - 3. 7
 - 4. 4

Q.47 Who among the following introduced binominal nomenclature of biological classification?

- Ans
- 1. Linnaeus
 - 2. Aristotle
 - 3. John Ray
 - 4. Charles Darwin

Q.48 Shambhu Maharaj was conferred the Sangeet Natak Akademi Fellowship for which form of dance?

- Ans
- 1. Manipuri
 - 2. Bharatanatyam
 - 3. Kathak
 - 4. Kuchipudi

Q.49 Who was the first Indian to qualify for the covenanted civil services in India?

- Ans
- 1. Subhas Chandra Bose
 - 2. Rajagopalachari
 - 3. Surendra Nath Banerjee
 - 4. Satyendra Nath Tagore

Q.50 Who wrote the novel 'Train to Pakistan'?

- Ans
- 1. Khushwant Singh
 - 2. Vikram Seth
 - 3. Mulk Raj Anand
 - 4. Bhisam Sahni

Section : Reasoning

Q.1 Select the figure from the given options that will replace the question mark (?) in the figure given below and complete the pattern.

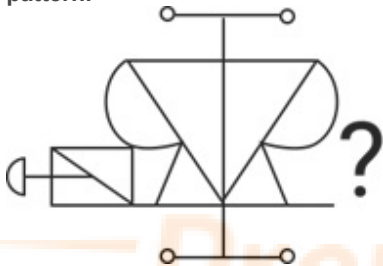

- Ans
- 1.
 - 2.
 - 3.
 - 4.

Q.2 If A denotes '+', B denotes 'x', C denotes '-', and D denotes '÷', then what will come in place of '?' in the following equation?
 $24 D (1 A 7) C 2 A 7 B 12 B (5 C 4) = ?$

- Ans
- 1. 83
 - 2. 85
 - 3. 88
 - 4. 96

Q.3 In a code language, if MUSIC is coded as 13-21-19-9-3 and BAND is coded as 2-1-14-4, then how will HARMONIUM

- Ans
- ✓ 1. 8-1-18-13-15-14-9-21-13
 - ✗ 2. 8-2-19-12-15-14-9-20-12
 - ✗ 3. 7-26-17-12-14-13-8-20-12
 - ✗ 4. 7-25-16-12-14-13-8-19-12

Q.4 Select the correct mirror image of the given figure when the mirror is placed at PQ as shown below.

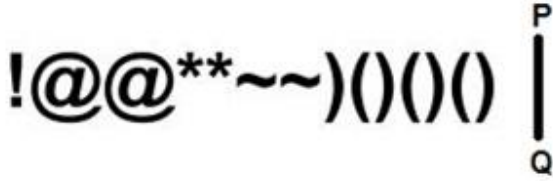

- Ans
- ✗ 1. () () (* * ~ ~ @ @ !
 - ✗ 2.) () () ~ ~ * * @ @ !
 - ✗ 3. () () (* * @ @ ~ ~ !
 - ✓ 4. () () (~ ~ * * @ @ !

Q.5 How many squares are there in the following figure?

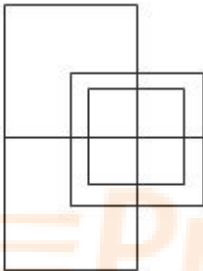

- Ans
- ✓ 1. 12
 - ✗ 2. 10
 - ✗ 3. 14
 - ✗ 4. 15

Q.6 A paper is folded and cut as shown below. How will it appear when unfolded?

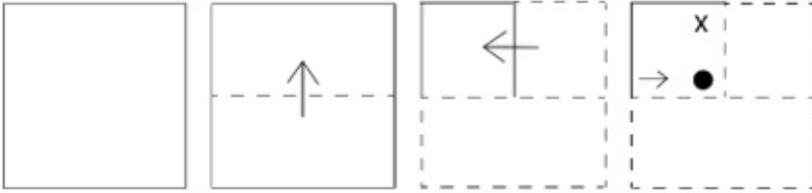

Ans

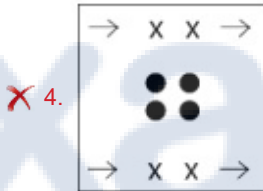
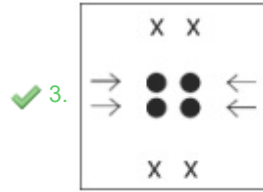
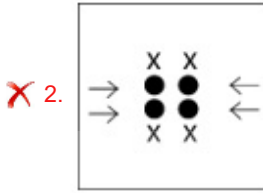
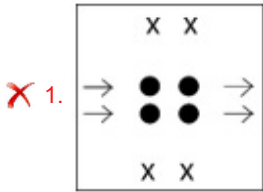

Q.7 Select the figure from the given options that will replace the question mark (?) in the figure given below and complete the pattern.

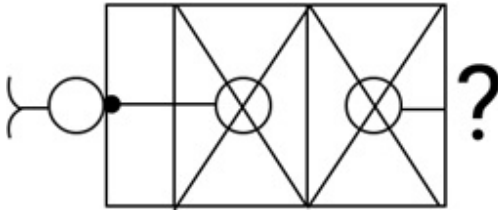

Ans



Prepare 50% Faster

Q.8 Select the figure from the given options that will replace the question mark (?) in the figure given below to complete the pattern.

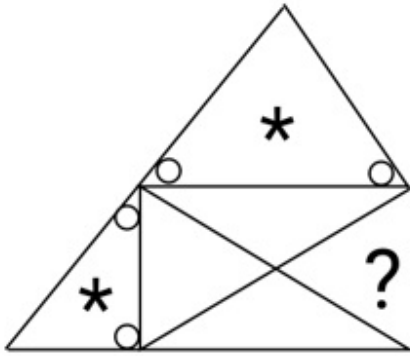

Ans

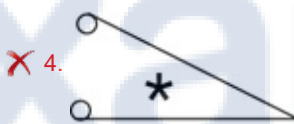
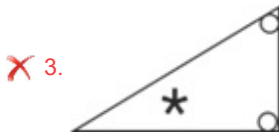
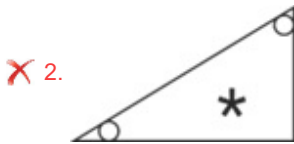
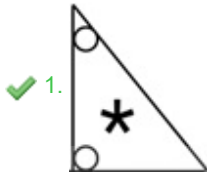

Q.9 Six letters A, B, C, P, Q and R are written on different faces of a dice. Two positions of this dice are shown in the figure. Find the letter on the face opposite to C.

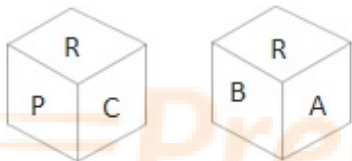

Ans ✓ 1. A

✗ 2. B

✗ 3. Q

✗ 4. P

Q.10 Which figure should replace the question mark (?) if the following series were to be continued?

X S	S D	D S	S ↑	↑ S	?
2	X	2	D	2	
T A	A 2	X A	A 2	D A	

Ans

✗ 1.

S D
↑
A 2

✓ 2.

S N
↑
A 2

✗ 3.

S 2
↑
A D

✗ 4.

S N
A
2 D

Q.11 Six students are sitting around a circular table facing the centre. Udit is an immediate neighbour of both Uday and Unnati. Umesh is sitting second to the right of Unnati. Utpal is sitting third to the left of Uday. Utsav is an immediate neighbour of both Umesh and Uday. Who is an immediate neighbour of both Umesh and Unnati?

- Ans
- ✗ 1. Udit
 - ✗ 2. Utsav
 - ✓ 3. Utpal
 - ✗ 4. Uday

Prepare 50% Faster

Q.12 Select the option in which the given figure is embedded (rotation is NOT allowed).

Ans

1.

2.

3.

4.

Q.13 Select the option that is related to the third word in the same way as the second word is related to the first word. (The words must be considered as meaningful English words and must NOT be related to each other based on the number of letters/number of consonants/vowels in the word)
Norway: Oslo:: Iran:?

- Ans
- 1. Madrid
 - 2. Baghdad
 - 3. Tehran
 - 4. Moscow

Prepare 50% Faster

Q.14 Select the correct mirror image of the given combination when the mirror is placed at 'MN' as shown below.

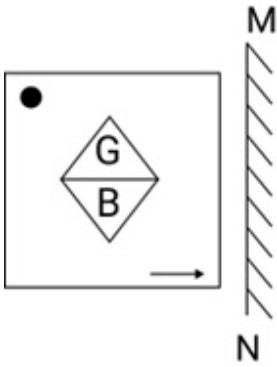

Ans

1.

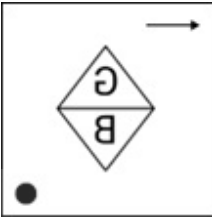

2.

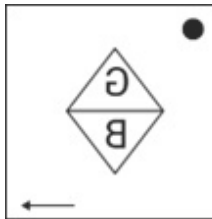

3.

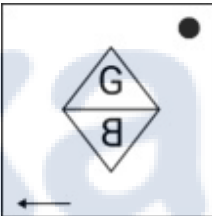

4.

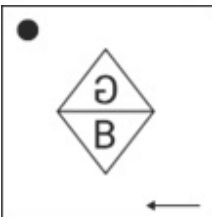

Q.15 Read the given statements and conclusions carefully. Assuming that the information given in the statements is true, even if it appears to be at variance with commonly known facts, decide which of the given conclusions logically follow(s) from the statements.

Statements:

Some stars are planets.

All stars are comets.

Conclusions:

I. Some comets are planets.

II. Some planets are stars.

Ans 1. Neither conclusion I nor II follows

2. Only conclusion I follows

3. Both conclusions I and II follow

4. Only conclusion II follows

Q.16 Which two signs should be interchanged to make the given equation correct?

$$35 + 76 - 98 \div 3 \times 6 = 62$$

Ans 1. + and ×

2. = and ×

3. - and +

4. ÷ and ×

Q.17 Select the figure that will come next in the following figure series.

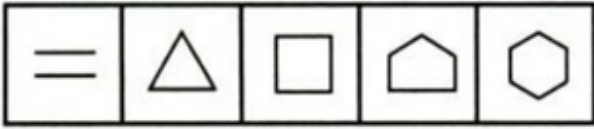

Ans

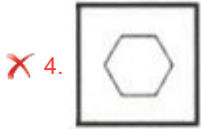
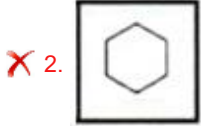
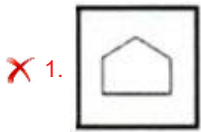

Q.18 Select the option that represents the letters that, when sequentially placed from left to right in the blanks below, will complete the letter series.

D _ A _ W _ S _ E W _ S A E _ D _ A E _

Ans

✗ 1. SEDADWES

✗ 2. SEDADSSW

✓ 3. SEDADWSW

✗ 4. SEDADESW

Prepare 50% Faster

Q.19 Which figure should replace the question mark (?) in the following series to continue the pattern?

L O S T	8 S O L	L 8 T S	O T 8 L	?
8 □ □	T O □ □	S		

Ans

✗ 1.

L O T S
8 □

✗ 2.

8 O T S
L □

✓ 3.

L O S T
8 □

✗ 4.

L O T 8
S □

Q.20 Select the number from among the given options that can replace the question mark (?) in the following series.

3, 21, 57, 129, 273, ?

Ans

✗ 1. 345

✗ 2. 234

✓ 3. 561

✗ 4. 456

Prepare 50% Faster

Q.21 Which of the following option figures will complete the pattern in the figure given below?

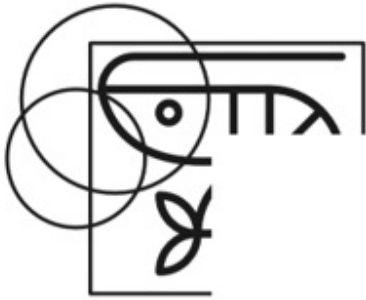

Ans

- 1.
- 2.
- 3.
- 4.

Q.22 Three different positions of the same dice are shown. Find the number on the face opposite the face showing '3'.

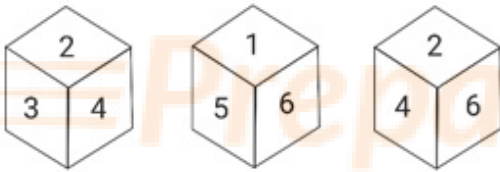

- 1. 6
- 2. 4
- 3. 5
- 4. 2

Q.23 Which of the following option figures will complete the pattern in the figure given below?



Ans

✓ 1.



✗ 2.



✗ 3.



✗ 4.

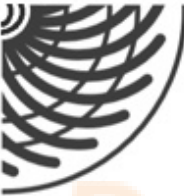

Q.24 14 is related to 27 following a certain logic. Following the same logic, 17 is related to 33. To which of the following is 24 related following the same logic?

Ans ✗ 1. 50

✓ 2. 47

✗ 3. 53

✗ 4. 56

Q.25 Study the given pattern carefully and select the number that can replace the question mark (?) in it.

First row - 56, 16, 60

Second row - 64, 18, 68

Third row - 72, 20, ?

(NOTE : Operations should be performed on the whole numbers, without breaking down the numbers into its constituent digits. Eg. 13 – Operations on 13 such as adding /subtracting/multiplying etc. to 13 can be performed. Breaking down 13 into 1 and 3 and then performing mathematical operations on 1 and 3 is not allowed)

Ans ✗ 1. 75

✗ 2. 78

✓ 3. 76

✗ 4. 74

Q.1 The price of an item is to be increased by 25% in two years. This year, the price increased to ₹140 from ₹120. What is the percentage increase in the next year?

- Ans
- 1. 7.14%
 - 2. 4.71%
 - 3. 7.41%
 - 4. 4.17%

Q.2 What will be the least common multiple of four numbers 15, 35, 42 and 72?

- Ans
- 1. 2025
 - 2. 2550
 - 3. 2520
 - 4. 2050

Q.3 Which of the following is the smallest ratio?

- Ans
- 1. 17 : 25
 - 2. 7 : 21
 - 3. 15 : 20
 - 4. 21 : 25

Q.4 Meera made a profit of 5% by selling a bag after offering a discount of 10%. If the marked price of bag is ₹1,050, find its cost price.

- Ans
- 1. ₹850
 - 2. ₹900
 - 3. ₹1,000
 - 4. ₹508

Q.5 If Malay buys guavas at ₹300 per kg and sells them at ₹25 per 100 gm., then he will have (rounded off to 2 decimal places):

- Ans
- 1. a loss of 16.67%
 - 2. a profit of 16.67%
 - 3. a profit of 25.25%
 - 4. a loss of 25.25%

Q.6 A certain sum is lent on simple interest at 4% p.a. for 3 years, 8% p.a. for the next 4 years, and 12% p.a. beyond 7 years. If for a period of 11 years, the simple interest obtained is ₹27,600, the sum is (in ₹):

- Ans
- 1. 30,000
 - 2. 28,000
 - 3. 25,000
 - 4. 32,000

Q.7 If 25 people, working 15 hours a day, can complete 5 units of work in 8 days, then how many days will be required by 12 people to complete 10 units of work, working 20 hours a day?

- Ans
- 1. 25 days
 - 2. 20 days
 - 3. 24 days
 - 4. 22 days

Q.8 The average of $1^2, 2^2, 3^2, 4^2, 5^2, 6^2, 7^2, 8^2$ and 9^2 is:

- Ans
- 1. $33\frac{1}{3}$
 - 2. $32\frac{1}{3}$
 - 3. $31\frac{2}{3}$
 - 4. $34\frac{2}{3}$

Q.9 A sum of ₹66,550 is taken on loan. This is to be paid back in two equal instalments. If the rate of interest is 20% compounded annually, find the value of each instalment.

- Ans
- 1. ₹43,560
 - 2. ₹44,550
 - 3. ₹42,560
 - 4. ₹40,550

Q.10 The price of an article has been reduced by 20%. In order to restore the original price, the new price must be increased by:

- Ans
- 1. 20%
 - 2. 22%
 - 3. 25%
 - 4. 28%

Q.11 The highest common factor (HCF) of 256, 136 and 436 is _____.

- Ans
- 1. 4
 - 2. 8
 - 3. 2
 - 4. 12

Q.12 If a solid sphere of radius 20 cm is moulded into 8 solid spherical balls of equal radius, then the radius of each ball will be: (Where $\pi = \frac{22}{7}$)

- Ans
- 1. 10 cm
 - 2. 12.5 cm
 - 3. 11 cm
 - 4. 11.5 cm

Q.13 What is the diameter of a sphere that has a surface area of 2500π cm²?

- Ans
- 1. 40 cm
 - 2. 50 cm
 - 3. 35 cm
 - 4. 25 cm

Q.14 A train approaches a tunnel MN. Inside the tunnel is a dog located at a point that is $\frac{2}{5}$ of the distance MN measured from the entrance M. When the train whistles, the dog runs. If the dog moves towards the entrance of the tunnel M, the train catches the dog exactly at the entrance M. If the dog moves towards the exit N, the train catches the dog exactly at the exit N. Find the ratio of the speed of the dog to that of the train?

- Ans**
- 1. 1 : 2
 - 2. 5 : 1
 - 3. 2 : 1
 - 4. 1 : 5

Q.15 What is the sum of the square of the prime numbers between 20 and 30?

- Ans**
- 1. 1370
 - 2. 1500
 - 3. 1276
 - 4. 1290

Section : Computer Proficiency

Q.1 In Microsoft Excel 365, which tool should we use for creating or editing formulas in a worksheet?

- Ans**
- 1. Auditing toolbar
 - 2. Formula bar
 - 3. Precedents
 - 4. Watch window

Q.2 What does the following icon resemble in MS Word 365 ?



- Ans**
- 1. Right alignment
 - 2. Left alignment
 - 3. Justifying
 - 4. Centre of text

Q.3 What action should be taken to add a new row or column in a spreadsheet?

- Ans**
- 1. Select a row or column, press the 'Ctrl+X' keyboard shortcut to cut it, and then press 'Ctrl+V' to paste it in the desired location.
 - 2. Highlight a range of cells, right-click, and choose 'Delete' from the context menu to create space for the new row or column.
 - 3. Use the 'Find and Replace' function to search for a specific cell, and then insert a new row or column using the results.
 - 4. Right-click on an existing row or column and select 'Insert' from the context menu.

Q.4 In which of the following tabs in MS Word 365 is Bullets and Numbering present?

- Ans
- 1. Edit
 - 2. Home
 - 3. File
 - 4. Page layout

Q.5 What does the 'Orientation' option in the Page Setup menu in Microsoft Word 365 allow you to change?

- Ans
- 1. Font style
 - 2. Text alignment
 - 3. Page layout (portrait or landscape)
 - 4. Page size

Q.6 What is the purpose of the CC field in an email?

- Ans
- 1. To include additional recipients who should be kept informed
 - 2. To request a read receipt from the recipient
 - 3. To encrypt the email for added security
 - 4. To indicate that the email is of high importance

Q.7 Which of the following shortcut key is used to insert a hyperlink in MS Word 365?

- Ans
- 1. Ctrl + K
 - 2. Shift + K
 - 3. Ctrl + H
 - 4. Shift + H

Q.8 Which of the following is a private network that is typically open to external parties, such as business partners, suppliers, and key customers?

- Ans
- 1. Telnet
 - 2. Intranet
 - 3. Internet
 - 4. Extranet

Q.9 Which text alignment option in Microsoft Word 365 aligns text along the left margin?

- Ans
- 1. Right Align
 - 2. Left Align
 - 3. Justify
 - 4. Center Align

Q.10 Which of the following is the correct way to sort a range of cells in ascending order in MS Excel 365?

- Ans
- 1. Click on the 'Review' tab and select 'Sort'.
 - 2. Select the range of cells and press 'Ctrl + Shift + S'.
 - 3. In the 'Sort' dialog box, select the 'Ascending' option in the 'Order' section.
 - 4. Click on the 'OK' button.

Constable Executive Male and Female in Delhi Police Examination 2023

Exam Date	15/11/2023
Exam Time	12:00 PM - 1:30 PM
Subject	Constable Executive Male and Female in Delhi Police Examination 2023

Section : General Knowledge

Q.1 'Godaan', a famous novel, was authored by _____.

- Ans**
- 1. Suryakant Tripathi Nirala
 - 2. Harivansh Rai Bachchan
 - 3. Munshi Premchand
 - 4. Jaishankar Prasad

Q.2 Who among the following was one of the court poets of the King Samudragupta?

- Ans**
- 1. Pragyajan
 - 2. Hariharan
 - 3. Harisena
 - 4. Surdas

Q.3 Name the Indian social reformer who played a crucial role in the passing of the Age of Consent Bill, 1891.

- Ans**
- 1. Ishwarchandra Vidyasagar
 - 2. Behramji Malabari
 - 3. Rabindranath Tagore
 - 4. C Subramania Bharathi

Q.4 Identify the artist who is NOT related to the musical instrument pakhwaj.

- Ans**
- 1. Gopal Das
 - 2. Totaram Sharma
 - 3. Ayodhya Prasad
 - 4. Pandit Kishan Maharaj

Q.5 Which of the following Constitutional Amendment Acts added Fundamental Duties in the Indian Constitution?

- Ans**
- 1. 42nd
 - 2. 65th
 - 3. 74th
 - 4. 73rd

Q.6 FIH Asia Cup Men's Hockey 2022 was hosted by:

- Ans**
- 1. Pakistan
 - 2. Indonesia
 - 3. Japan
 - 4. India

Q.7 According to the Census of India 2011, which group of states recorded the lowest male literacy rate?

- Ans
- 1. Bihar and Arunachal Pradesh
 - 2. Arunachal Pradesh and Odisha
 - 3. Rajasthan and Arunachal Pradesh
 - 4. Bihar and Rajasthan

Q.8 Economic reform measures in India were formally introduced in _____.

- Ans
- 1. 1990
 - 2. 1991
 - 3. 1980
 - 4. 1947

Q.9 Who became the first Indian woman to win two Olympic medals?

- Ans
- 1. Saina Nehwal
 - 2. Karnam Malleswari
 - 3. PV Sindhu
 - 4. Mary Kom

Q.10 Milk is good source of:

- Ans
- 1. calcium, iron, and fibre
 - 2. calcium, phosphorous, and protein
 - 3. calcium, magnesium, and fibre
 - 4. phosphorous, iron, and protein

Q.11 The Ghode Modni dance, to celebrate the victory of warriors, is performed in which of the following states of India?

- Ans
- 1. Karnataka
 - 2. Goa
 - 3. West Bengal
 - 4. Tamil Nadu

Q.12 Which of the following State Governments organises Surajkund Mela every year?

- Ans
- 1. Jharkhand
 - 2. Jammu
 - 3. Punjab
 - 4. Haryana

Q.13 निम्नलिखित में से किस मंत्रालय ने 'वेंचर पूंजी सहायता योजना' शुरू की है?

- Ans
- 1. कृषि और किसान कल्याण मंत्रालय
 - 2. सूक्ष्म, लघु और मध्यम उद्यम मंत्रालय
 - 3. वित्त मंत्रालय
 - 4. विज्ञान और प्रौद्योगिकी मंत्रालय

Q.14 Sonal Mansingh is an eminent Indian classical dancer and a leading exponent of Bharatanatyam, Kuchipudi, Odissi and _____.

- Ans
- 1. Chhau
 - 2. Sattriya
 - 3. Kathak
 - 4. Kathakali

Q.15 Expenditure incurred by residents during their foreign tour will be added to which component while calculating national income?

- Ans
- 1. Government final consumption expenditure
 - 2. Private final consumption expenditure
 - 3. Gross domestic capital formation
 - 4. Gross foreign capital formation

Q.16 Who among the following was the first person in British India to get the scholarship of Indian Society of Oriental Arts, established in 1906?

- Ans
- 1. Subrahmanyam Chandrasekhar
 - 2. Prafulla Chandra Roy
 - 3. Jagdish Chandra Bose
 - 4. Nandalal Bose

Q.17 Gram Nyayalaya Act was enacted in the year _____.

- Ans
- 1. 2008
 - 2. 2000
 - 3. 2006
 - 4. 2004

Q.18 निम्नलिखित में से कौन-सा कथन 1950 और 1990 के बीच की अवधि के लिए भारत के बारे में सही है?

- Ans
- 1. कृषि द्वारा योगदान किए गए सकल घरेलू उत्पाद के अनुपात में उल्लेखनीय कमी हुई, लेकिन इस क्षेत्र में लगी जनसंख्या में कमी नहीं हुई।
 - 2. कृषि द्वारा योगदान किए गए सकल घरेलू उत्पाद के अनुपात में और इस क्षेत्र में लगी जनसंख्या में उल्लेखनीय कमी हुई।
 - 3. कृषि द्वारा योगदान किए गए सकल घरेलू उत्पाद के अनुपात में उल्लेखनीय वृद्धि हुई, लेकिन इस क्षेत्र में लगी जनसंख्या में वृद्धि नहीं हुई।
 - 4. कृषि-आधारित अर्थव्यवस्था होने के नाते, कृषि क्षेत्र का योगदान भारतीय अर्थव्यवस्था के लिए उल्लेखनीय नहीं है।

Q.19 According to the Ministry of Commerce and Industry 2021-22, which of the following is the largest exported agricultural product from India?

- Ans
- 1. Wheat
 - 2. Spices
 - 3. Maize
 - 4. Rice

Q.20 When did the Paris Agreement on Climate Change come into force (become effective from)?

- Ans
- 1. 27th January 2017
 - 2. 4th November 2016
 - 3. 22nd April 2016
 - 4. 12th December 2015

Q.21 According to Census 2011, which group of states have the highest males literacy rates?

- Ans
- 1. Kerala and Mizoram
 - 2. Rajasthan and Bihar
 - 3. Sikkim and Nagaland
 - 4. Kerala and Tamil Nadu

Q.22 Net investment can be best expressed using which of the following elements?

- Ans
- 1. Depletion Value
 - 2. Gross Investment-Depreciation
 - 3. Net investment-Depreciation
 - 4. Replacement Cost

Q.23 Who was India's 12th Prime Minister?

- Ans
- 1. Manmohan Singh
 - 2. PV Narasimha Rao
 - 3. Inder Kumar Gujral
 - 4. Atal Bihari Vajpayee

Q.24 Which of the following dance forms belongs to the Vaishnava Monasteries of North East India?

- Ans
- 1. Kuchipudi
 - 2. Sattriya
 - 3. Mohiniattam
 - 4. Odissi

Q.25 'Why I am an Atheist' is an autobiography of whom among the following Revolutionaries?

- Ans
- 1. Suryakant Sen
 - 2. Ramprasad Bismil
 - 3. Bhagat Singh
 - 4. Chandrashekhar Azad

Q.26 'Mahatma Gandhi National Fellowship' ('MGNF') is a two-year academic programme that was launched by _____ in 2020 as part of the SANKALP programme.

- Ans
- 1. IIT Delhi
 - 2. IIM Ahmedabad
 - 3. IIM Bangalore
 - 4. IIT Madras

Q.27 Which form of art is celebrated at the Mando festival of Goa?

- Ans
- 1. Sports
 - 2. Painting
 - 3. Music
 - 4. Literature

Q.28 According to Census 2011, what was the population density of India?

- Ans
- 1. 343 persons
 - 2. 362 persons
 - 3. 372 persons
 - 4. 382 persons

Q.29 In which king's honour and praise was the Prayag Prashasti written by the Sanskrit poet Harisena?

- Ans
- 1. Samudragupta
 - 2. Chandragupta
 - 3. Vikramaditya
 - 4. Ashoka

Q.30 The first chairman of the Planning Commission in India was _____.

- Ans
- 1. Jawaharlal Nehru
 - 2. Jaiprakash Narayan
 - 3. Radha Mohan Singh
 - 4. Sriman Narayan

Q.31 Untouchability is against which of the following fundamental rights?

- Ans
- 1. Right to constitutional remedy
 - 2. Right to equality
 - 3. Right to freedom of religion
 - 4. Right to liberty

Q.32 Which of the following Articles provides the minorities the right to establish and administer educational institutions of their choice?

- Ans
- 1. Article 31
 - 2. Article 28
 - 3. Article 29
 - 4. Article 30

Q.33 भारत के संविधान में सरकार के कितने स्तरों का उल्लेख किया गया है?

- Ans
- 1. दो
 - 2. पाँच
 - 3. तीन
 - 4. चार

Q.34 When was the Bengal Partition Plan implemented?

- Ans
- 1. 16 October 1905
 - 2. 10 September 1910
 - 3. 15 August 1915
 - 4. 7 August 1899

Q.35 The Charminar was constructed by which of the following dynasties?

- Ans
- 1. Pandya
 - 2. Qutb Shahi
 - 3. Chera
 - 4. Chalukya

Q.36 The Wazir (minister) of _____ built Moth ki Masjid in Delhi.

- Ans
- 1. Sikandar Lodi
 - 2. Khizr Khan
 - 3. Firuz Shah Tughluq
 - 4. Alauddin Khalji

Q.37 Who among the following was the captain of the Indian cricket team in the 1983 World Cup?

- Ans
- 1. Kapil Dev
 - 2. Sunil Gavaskar
 - 3. Mohinder Amarnath
 - 4. Dilip Vengsarkar

Q.38 हल्दी पाउडर में किसकी मिलावट होती है?

- Ans
- 1. जिंक कार्बोनेट
 - 2. लेड क्रोमेट
 - 3. सिलिकॉन ऑक्साइड
 - 4. मैग्नीशियम क्लोराइड

Q.39 गीता महालिक ने किस प्रकार के नृत्य के लिए संगीत नाटक अकादमी पुरस्कार जीता?

- Ans
- 1. भरतनाट्यम
 - 2. ओडिसी
 - 3. कथकली
 - 4. कुचिपुडी

Q.40 Who among the following is associated with the Mridangam instrument?

- Ans
- 1. Palghat Mani Iyer
 - 2. Zarin S Sharma
 - 3. Hari Prasad Chaurasia
 - 4. Ali Akbar Khan

Q.41 Which state has two headquarters of Indian Railway Zones?

- Ans
- 1. Rajasthan
 - 2. Bihar
 - 3. Uttar Pradesh
 - 4. Assam

Q.42 निम्नलिखित में से कौन-सा/से कथन सही है/हैं?

- a) भारतीय रेगिस्तान अरावली पर्वतमाला के पूर्वी छोर पर स्थित है। यह रेत के टीलों से ढका एक लहरदार रेतीला मैदान है।
b) इस क्षेत्र में कम वनस्पति आवरण के साथ शुष्क जलवायु पाई जाती है और बरसात के मौसम में जलधाराएं दिखाई देती हैं।

- Ans
- 1. a और b दोनों गलत हैं।
 - 2. केवल a सही है।
 - 3. a और b दोनों सही हैं।
 - 4. केवल b सही है।

Q.43 What is the chemical formula of sodium nitrate?

- Ans
- 1. NaNO_2
 - 2. NaNH_3
 - 3. NaNO_3
 - 4. NaNO_4

Q.44 By which name was the Head of the Panchayat or the Village Headman called in Mughal India?

- Ans
- 1. Khoran
 - 2. Samant
 - 3. Mahant
 - 4. Muqaddam

Q.45 Which is the most common tidal pattern?

- Ans
- 1. Diurnal tides
 - 2. Spring tides
 - 3. Mixed tides
 - 4. Semi-diurnal tides

Q.46 Elections under which act gave the control of seven provinces in 1937 to the Congress?

- Ans
- 1. Government of India Act, 1937
 - 2. Provincial Act, 1935
 - 3. Municipalities Act, 1935
 - 4. Government of India Act, 1935

Q.47 Sodium hydrogen carbonate is called:

- Ans
- 1. Plaster of Paris
 - 2. Washing soda
 - 3. Gypsum
 - 4. Baking soda

Q.48 Which of the following temples is located in Uttarakhand?

- Ans
- 1. Neelkanth Mahadev
 - 2. Ranakpur
 - 3. Kamakhya
 - 4. Gomateshwara

Q.49 The three-second rule is applicable for the game of _____.

- Ans
- 1. basketball
 - 2. kabaddi
 - 3. badminton
 - 4. kho-kho

Q.50 Which of the following is a merit of the parliamentary system?

- Ans
- 1. Narrow representation
 - 2. Harmony between legislature and executive
 - 3. Non responsible government
 - 4. Autocracy

Section : Reasoning

Q.1 Which figure should replace the question mark (?) if the series were to be continued?

Z	L	T	3	L	T	3	O	
	O		Z		P		L	?
3		T	L	O	O	3	T	P

Ans

1.

T		3
	☆	
P		O

2.

O		P
	L	
3		T

3.

P		T
	O	
L		3

4.

O		P
	☆	
3		T

Q.2 Select the option that is related to the fifth letter-cluster in the same way as the second letter-cluster is related to letter-cluster and the fourth letter-cluster is related to the third letter-cluster.
KEEP : SHHN :: HIDE : HGLK :: EXIT : ?

- Ans
- 1. WLAI
 - 2. WLAH
 - 3. XLAH
 - 4. WMBH

Q.3 Select the option figure which is embedded in the given figure as its part (rotation is NOT allowed).

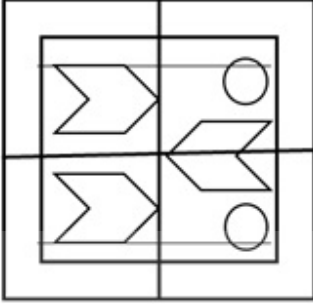

- Ans
- 1.
 - 2.
 - 3.
 - 4.

Q.4 Select the correct mirror image of the given figure when the mirror is placed at MN as shown below.



- Ans
- 1. X4202TAU
 - 2. X4502TAU
 - 3. X4202TAU
 - 4. X4202TAU

Q.5 Two statements are given followed by two conclusions numbered I and II. Assuming the statements to be true, even if they seem to be at variance with commonly known facts, decide which of the conclusions logically follow(s) from the statements:
Statements:
 All hens are dogs.
 All dogs are peacocks.
Conclusions:
 I. All hens are peacocks.
 II. All peacocks are dogs.

- Ans**
- 1. Only conclusion II follows
 - 2. Only conclusion I follows
 - 3. Both conclusions I and II follow
 - 4. Neither conclusion I nor II follows

Q.6 Which of the following option figures will complete the pattern in the figure given below?



Ans

- 1.
- 2.
- 3.
- 4.

Q.7 Which of the following letter clusters will replace the question mark (?) in the given series to make it logically complete?
 RTE, PVC, NXA, LZY, ?

- Ans**
- 1. KXV
 - 2. JBW
 - 3. JBA
 - 4. JBX

Q.8 Each of the following questions consists of 4 figures marked 1, 2, 3 and 4 called the Problem Figures followed by 4 other figures. Select a figure from amongst the Answer Figures which will continue the same series as established by the four Problem Figures.

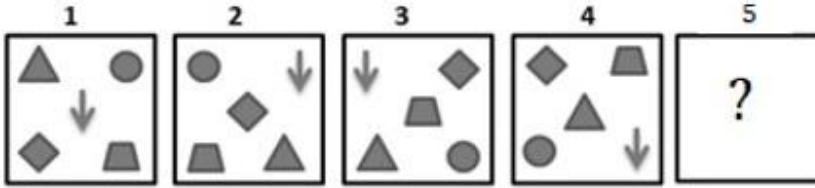

Ans

- ✓ 1.
- ✗ 2.
- ✗ 3.
- ✗ 4.

Q.9 Select the set in which the numbers are NOT related in the same way as are the numbers of the following sets.

(59, 236, 175), (24, 124, 98)

(NOTE: Operations should be performed on the whole numbers, without breaking down the numbers into its constituent digits.)

- Ans**
- ✓ 1. (21, 124, 108)
 - ✗ 2. (16, 206, 188)
 - ✗ 3. (22, 183, 159)
 - ✗ 4. (64, 182, 116)

Q.10 In a code language, if PETROL is coded as ODSQNK and ENGINE is coded as DMFHMD, then how will VEHICLE be coded?

- Ans**
- ✓ 1. UDGHBKD
 - ✗ 2. WFIJDMF
 - ✗ 3. UDHGKBD
 - ✗ 4. WDIHDKF

Q.11 Select the correct mirror image of the given combination when the mirror is placed at MN as shown below.

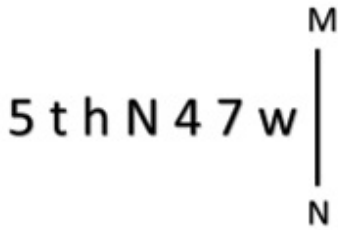

- Ans
- ✓ 1. w 7 4 N h t 5
 - ✗ 2. w 7 N 4 t t 5
 - ✗ 3. w 7 4 N 4 t 5
 - ✗ 4. 5 t h N 7 4 W

Q.12 Which of the following options will replace the question mark (?) in the given series?
13, 104, 52, 416, 208, ?, 832

- Ans
- ✗ 1. 790
 - ✗ 2. 690
 - ✗ 3. 1158
 - ✓ 4. 1664

Q.13 How many triangles are there in the following figure?

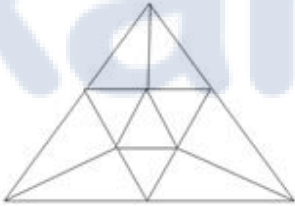

- Ans
- ✗ 1. 10
 - ✗ 2. 12
 - ✗ 3. 18
 - ✓ 4. 15

Prepare 50% Faster

Q.14 Select the figure from the given options that will replace the question mark (?) in the figure given below and complete the pattern.

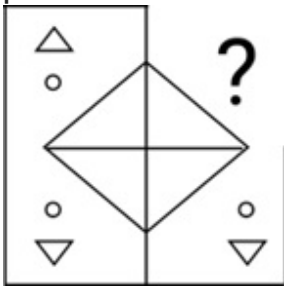

Ans

✓ 1.



✗ 2.



✗ 3.



✗ 4.



Q.15 C, D, E, F, G and H were six women, sitting around a circular table, equidistant from each other, facing the centre. D and E were sitting immediately next to each other. F and H were sitting immediately next to each other. G was to the immediate right of C. E was to the immediate right of F. D was to the immediate left of C. Who among the following was sitting third to the left of D?

Ans

✗ 1. F

✗ 2. G

✓ 3. H

✗ 4. C

Prepare 50% Faster

Q.16

Select the option figure which is embedded in the given figure. (Rotation is NOT al

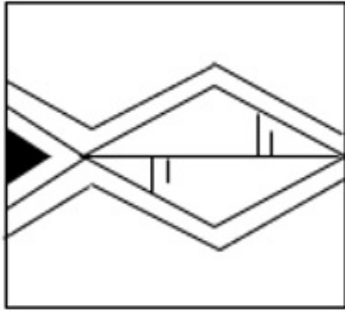

Ans

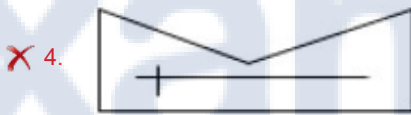
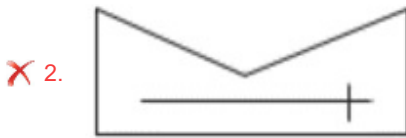
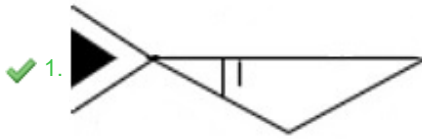

Q.17 Select the correct combination of mathematical signs to sequentially replace the * signs and to balance the given equation.
 $11 * 12 * 70 * 175 * 5 * 97$

- Ans
- ✗ 1. $\times, -, +, =, \div$
 - ✗ 2. $\times, +, -, \div, =$
 - ✓ 3. $\times, -, +, \div, =$
 - ✗ 4. $+, \times, -, \div, =$

Prepare 50% Faster

Q.18 Which figure should replace the question mark (?) if the series were to be continued?

6	□	2	6	□	☆	8	□
L		8		6		P	
2	☆	☆	□	8	2	2	☆

Ans

✗ 1.

2	8
3	
☆	□

✗ 2.

☆	2
P	
□	8

✗ 3.

☆	2
8	
□	P

✓ 4.

☆	2
□	
P	8

Q.19 Select the figure from the options that can replace the question mark (?) and complete the given pattern.

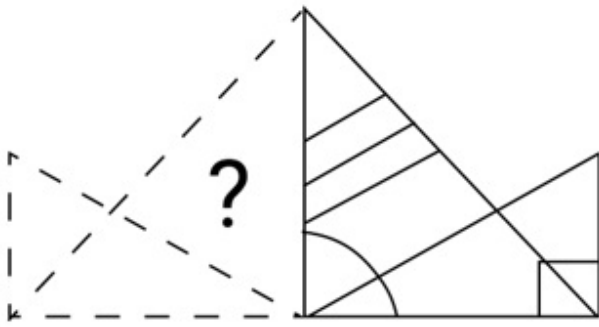

Ans

✗ 1.



✗ 2.

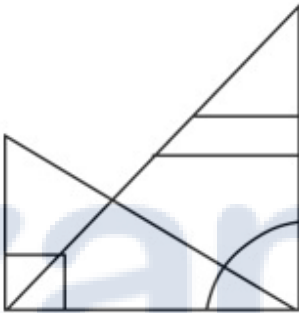

✗ 3.



✓ 4.

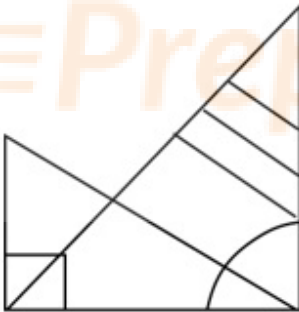

Q.20 Select the option that is related to the fourth term in the same way as the first term is related to the second term and the fifth term is related to the sixth term.
 $8 : 199 :: ? : 439 :: 5 : 82$

Ans ✓ 1. 12

✗ 2. 10

✗ 3. 16

✗ 4. 14

Q.21 Which two signs should be interchanged to make the given equation correct?
 $98 - 49 \div 7 + 74 \times 55 = 3$

- Ans
- 1. = and ÷
 - 2. = and ×
 - 3. = and -
 - 4. = and +

Q.22 A paper is folded and cut as shown below. How will it appear when unfolded?

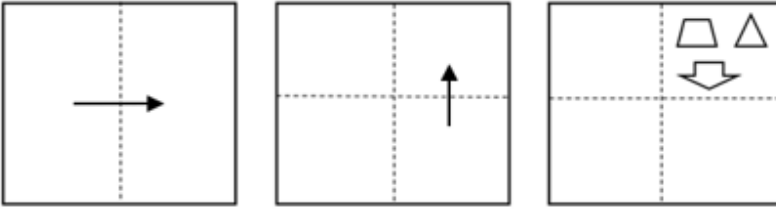

Ans

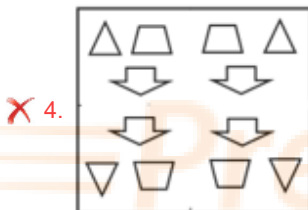
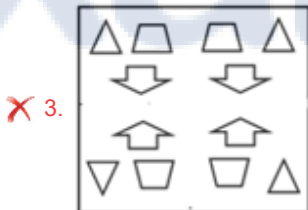
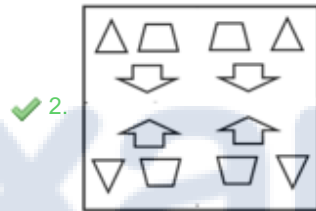
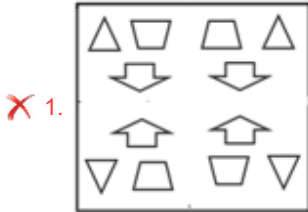

Q.23 Which of the following option figures will complete the pattern in the figure given below?

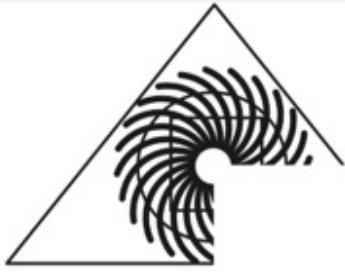

Ans

X 1.



X 2.



✓ 3.



X 4.



Q.24 A paper is folded and cut as shown below. How will it appear when unfolded?

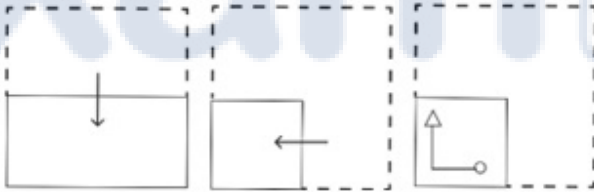

Ans

X 1.

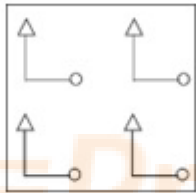

X 2.

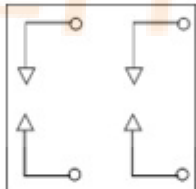

✓ 3.

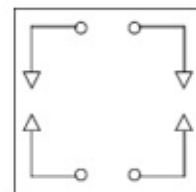

X 4.

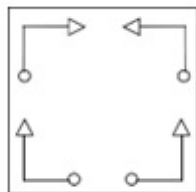

Q.25 A paper is folded and cut as shown below. How will it appear when unfolded?

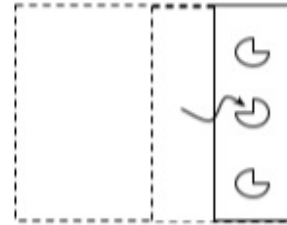
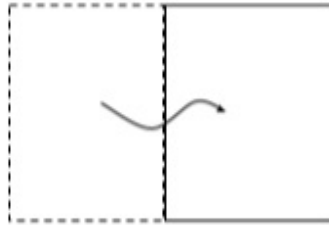

Ans

✗ 1.

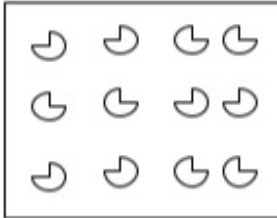

✗ 2.



✗ 3.

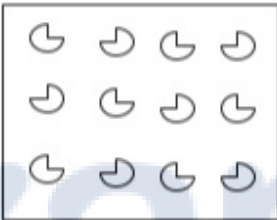

✓ 4.



Section : Numerical Ability

Q.1 The smallest 4-digit prime number is:

✗ 1. 1007

✓ 2. 1009

✗ 3. 1003

✗ 4. 1001

Q.2 A man loses 25% of his money. After spending 60% of the remaining money, he has ₹360 left. What is the amount of money (in ₹) he originally had?

✗ 1. 654

✗ 2. 1962

✗ 3. 2400

✓ 4. 1200

Q.3 Ajay's test marks in two subjects, Mathematics and Science, are in the ratio 9 : 13. If he got 16 marks more in Science than in Mathematics, what are his marks in Mathematics?

✓ 1. 36

✗ 2. 45

✗ 3. 54

✗ 4. 27

Q.4 What is the difference (in ₹) between the compound interest, when interest is compounded 6-monthly, and the simple interest on a sum of ₹10,000 for $1\frac{1}{2}$ years at 10% p.a.?

- Ans
- 1. 76.25
 - 2. 72.65
 - 3. 71.65
 - 4. 75.26

Q.5 Find the total percentage change in the volume of a cuboid if its length and breadth are decreased by 10% and 20%, respectively, while its height is increased by 30%.

- Ans
- 1. 8.6%
 - 2. 8.2%
 - 3. 6.4%
 - 4. 9.1%

Q.6 Trader A offers a discount of 25% on the marked price for cash purchase. Trader B offers a trade discount of 20% and a cash discount of 4% on the same article marked at the same price as that of Trader A. If the discount given by Trader A is ₹360 more than the discount given by Trader B, then what is the marked price of the item (in rupees)?

- Ans
- 1. 20,000
 - 2. 18,000
 - 3. 19,000
 - 4. 30,000

Q.7 If the average of 8, 6, 14, 7 and x is 11, then the value of x is:

- Ans
- 1. 15
 - 2. 20
 - 3. 18
 - 4. 22

Q.8 A person took a loan of ₹1,200 on simple interest for as many years as the rate of interest. If he paid ₹432 as interest at the end of the loan period, what was the rate of interest per annum?

- Ans
- 1. 8%
 - 2. 6%
 - 3. 5%
 - 4. 9%

Q.9 In an assembly, milk was served to 350 Scouts. Each one of them was given milk in cylindrical glasses with base radius 10 cm and height 15 cm. What amount of money was spent by the donor, if he purchased milk at the rate of ₹50 per litter? (Ignore the cost of cylindrical paper glasses etc)

- Ans
- 1. ₹80,000
 - 2. ₹82,500
 - 3. ₹83,000
 - 4. ₹81,000

Q.10 A policeman chases a thief. The speed of the policeman and thief is 8 km/h and 7 km/h, respectively. If the policeman started 6 minutes late, after running how much distance will he be able to catch the thief?

- Ans
- 1. 5.5 km
 - 2. 5.6 km
 - 3. 6 km
 - 4. 6.3 km

Q.11 Simplify $1.6 + 1.2 \times \frac{1}{4} - \left\{ \frac{1}{5} + (1 - 0.8) \right\}$.

- Ans
- 1. 1.6
 - 2. 1.8
 - 3. 1.4
 - 4. 1.5

Q.12 14 men can complete a piece of work in 6 days, while 20 women can complete the same work in 8 days. 7 men started working on the job, and after working for 3 days all of them stopped working. How many women should be put on the job to complete the remaining work, if it is to be completed in 6 days?

- Ans
- 1. 30
 - 2. 20
 - 3. 25
 - 4. 15

Q.13 By selling an article, a shopkeeper makes a profit of 30% of its selling price. Find his profit percentage.

- Ans
- 1. 44%
 - 2. 40%
 - 3. $46\frac{1}{3}\%$
 - 4. $42\frac{6}{7}\%$

Q.14 A hemispherical bowl is made of steel whose thickness is 2 cm. The inside radius of the bowl is 3 cm. Find the volume (in cm^3) of the steel used in making the bowl. (Rounded off to 2 decimal places)

(Take $\pi = \frac{22}{7}$)

- Ans
- 1. 205.33
 - 2. 280.75
 - 3. 245.14
 - 4. 211.25

Q.15 What is the greatest possible length (in cm) of scale to measure exactly the following lengths : 1 m, 20 cm, 3 m, 90 cm?

- Ans
- 1. 50
 - 2. 45
 - 3. 30
 - 4. 10

Section : Computer Proficiency

Q.1 Which of the following is an address on the world wide web that is used to access specific web resources and is the specific path to a resource?

- Ans
- 1. Hyperlink
 - 2. Web pages
 - 3. Uniform resource locator
 - 4. Web server

Q.2 The keyboard shortcut for opening a new document in Microsoft Word 365, while another document is already open is _____.

- Ans
- 1. Ctrl + S
 - 2. Ctrl + Y
 - 3. Ctrl + P
 - 4. Ctrl + N

Q.3 Which of the following is NOT used to edit text in MS-Word 365?

- Ans
- 1. Changing Font Style
 - 2. Making text as Left align
 - 3. Changing Font Color
 - 4. Making text as Bold/Italic

Q.4 Which of the following document settings can be changed from the layout tab of MS word 365?

- Ans
- 1. Macros
 - 2. Margins
 - 3. Change styles
 - 4. Spelling grammar

Q.5 Which of the following is used to print the document in MS-Word 365?

- Ans
- 1. Home->print
 - 2. File->print
 - 3. View->print
 - 4. Design->print

Q.6 In MS Excel 365, Which function from the following list is used to tally the quantity of empty cells within a specified cell range?

- Ans
- 1. COUNTA()
 - 2. COUNT()
 - 3. COUNTB()
 - 4. COUNTBLANK()

Q.7 ईमेल लिखते समय उपयोगकर्ता को 'Subject' फ़ील्ड में क्या लिखना होता है?

- Ans
- 1. प्राप्तकर्ता का ईमेल एड्रेस
 - 2. प्रेषक का ईमेल एड्रेस
 - 3. ईमेल को अधिक रोचक बनाने के लिए एक स्माइली या इमोजी
 - 4. ईमेल मैसेज का मुख्य विषय

Q.8 Which of the following statements about autofitting the row height in MS Excel 365 is correct?

- Ans
- 1. Double-clicking on the boundary between column headers will automatically adjust the column height to fit the content.
 - 2. Single-clicking on the boundary between column headers will automatically adjust the column height to fit the content.
 - 3. Double-clicking on the boundary between row headers will automatically adjust the row height to fit the content.
 - 4. Single-clicking on the boundary between row headers will automatically adjust the row height to fit the content.

Q.9 Which Microsoft Excel 365, function is used to join or concatenate text strings from different cells?

- Ans
- 1. ADD
 - 2. CONCATENATE
 - 3. JOIN
 - 4. MERGE

Q.10 Which of the following tabs in MS Word 365, allows you to customise the page size in the Page Setup dialog box'

Ans 1. Insert

2. Edit

3. Layout

4. File



Prepare 50% Faster

Constable Executive Male and Female in Delhi Police Examination 2023

Exam Date	15/11/2023
Exam Time	3:00 PM - 4:30 PM
Subject	Constable Executive Male and Female in Delhi Police Examination 2023

Section : General Knowledge

Q.1 Till 1993-94, the poverty line was based on ____ data.

- Ans**
- 1. Mixed Reference Period
 - 2. Mixed Research Period
 - 3. Uniform Research Period
 - 4. Uniform Resource Period

Q.2 Which of the following is NOT an element of the Competition Act 2002?

- Ans**
- 1. Abuse of dominant position
 - 2. Prohibition of trade
 - 3. Regulation of combination
 - 4. Prohibition of anti-competitive agreements

Q.3 Mormugao Port is located in which state?

- Ans**
- 1. Tamil Nadu
 - 2. Maharashtra
 - 3. West Bengal
 - 4. Goa

Q.4 In which of the following kingdoms is the eukaryotic cell NOT found?

- Ans**
- 1. Animalia
 - 2. Protista
 - 3. Fungi
 - 4. Monera

Q.5 Who among the following is a Sangeet Natak Akademi award-winning Bharatanatyam dancer?

- Ans**
- 1. M Sailaja
 - 2. Kumkum Dhar
 - 3. Jayalakshmi Eshwar
 - 4. Sunanda Nair

Q.6 Kanheri Caves built by the Buddhists are located in which of the following states?

- Ans**
- 1. Bihar
 - 2. Maharashtra
 - 3. Madhya Pradesh
 - 4. Gujarat

Q.7 The festival of Pushkaralu is celebrated to promote the cultural heritage of which Indian state?

- Ans**
- 1. Andhra Pradesh
 - 2. Kerala
 - 3. Karnataka
 - 4. Tamil Nadu

Q.8 When was Tattvabodhini Sabha established?

- Ans**
- 1. 1839
 - 2. 1851
 - 3. 1843
 - 4. 1831

Q.9 As per Census 2011, which of the following states/union territories has the highest male literacy rate?

- Ans**
- 1. Kerala
 - 2. Mizoram
 - 3. Chandigarh
 - 4. Lakshadweep

Q.10 Which of the following international organisations is the governing body of chess?

- Ans**
- 1. ICC
 - 2. FIDE
 - 3. FIFA
 - 4. IOC

Q.11 Which of the following cricketers has written an autobiography titled 'Six Machine'?

- Ans**
- 1. Adam Gilchrist
 - 2. Chris Gayle
 - 3. Jacques Kallis
 - 4. Brendon McCullum

Q.12 Who among the following Gupta kings is popularly known as the Napoleon of India?

- Ans**
- 1. Samudragupta
 - 2. Ghatotkacha
 - 3. Kumaragupta I
 - 4. Vishnugupta

Q.13 Name the freedom fighter who became the Editor of Communist Journal 'Vanguard'.

- Ans**
- 1. P Krishna Pillai
 - 2. K Kelappan
 - 3. MN Roy
 - 4. C Rajagopalachari

Q.14 In which year did the Indian Government develop 'SMILE' ('Support for Marginalized Individuals for Livelihood and Enterprise')?

- Ans**
- 1. 2018
 - 2. 2021
 - 3. 2019
 - 4. 2022

Q.15 Who among the following was given the title of 'Queen of Kathak' by Gurudev Rabindranath Tagore?

- Ans
- 1. Sanjukta Panigrahi
 - 2. Shanta Rao
 - 3. Rukmini Devi Arundale
 - 4. Sitara Devi

Q.16 As we go down under water in a ocean the water pressure:

- Ans
- 1. increases
 - 2. remains less than atmospheric pressure
 - 3. decreases
 - 4. remains constant and equal to the atmospheric pressure

Q.17 86वें संवैधानिक अधिनियम, 2002 द्वारा निम्नलिखित में से कौन सा मौलिक कर्तव्य जोड़ा गया था?

- Ans
- 1. प्राकृतिक पर्यावरण का संरक्षण और सुधार करना
 - 2. भारत की संप्रभुता, एकता और अखंडता को बनाए रखना और उसकी रक्षा करना
 - 3. सार्वजनिक संपत्ति की सुरक्षा करना
 - 4. 6 से 14 वर्ष के बीच के अपने बच्चे को शिक्षा के अवसर प्रदान करना

Q.18 Which of the following organisations established in 1875 opposes idol worship and upholds the infallibility of the Vedas?

- Ans
- 1. Arya Samaj
 - 2. Ramakrishna Mission
 - 3. Prarthana Samaj
 - 4. Paramahansa Mandali

Q.19 मक्कू, तुइवई, सोनाई और रुक्नी किस नदी की सहायक नदियाँ हैं?

- Ans
- 1. साबरमती
 - 2. पेन्नार
 - 3. तापी
 - 4. बराक

Q.20 निम्नलिखित में से कौन-सा संवैधानिक संशोधन अधिनियम भारतीय संविधान में ग्यारहवें मौलिक कर्तव्य को जोड़ने से संबंधित है?

- Ans
- 1. 81वाँ संवैधानिक संशोधन अधिनियम
 - 2. 86वाँ संवैधानिक संशोधन अधिनियम
 - 3. 83वाँ संवैधानिक संशोधन अधिनियम
 - 4. 69वाँ संवैधानिक संशोधन अधिनियम

Q.21 The headquarters of West Central Railway Zone of Indian Railway is located in _____.

- Ans
- 1. Bhopal
 - 2. Jabalpur
 - 3. Agra
 - 4. Jaipur

Q.22 The first edition of the Commonwealth Youth Games was held in the year:

- Ans
- 1. 2008
 - 2. 2004
 - 3. 2000
 - 4. 2011

Q.23 किस समिति ने सुझाव दिया कि करों का भुगतान करना भी नागरिकों का मौलिक कर्तव्य होना चाहिए?

- Ans
- 1. चरण सिंह समिति
 - 2. स्वर्ण सिंह समिति
 - 3. जे एस वर्मा समिति
 - 4. भूटा सिंह समिति

Q.24 'Sunny Days: An Autobiography' is written by which of the following Indian cricketers?

- Ans
- 1. Kapil Dev
 - 2. Rahul Dravid
 - 3. Sunil Gavaskar
 - 4. Mohinder Amarnath

Q.25 विधान-परिषद के सदस्य के रूप में निर्वाचित होने के लिए किसी व्यक्ति की आयु _____ वर्ष से कम नहीं होनी चाहिए।

- Ans
- 1. 30
 - 2. 25
 - 3. 21
 - 4. 35

Q.26 हाथीगुम्फा शिलालेख किस भाषा में उत्कीर्णित है?

- Ans
- 1. पाली
 - 2. मराठी
 - 3. संस्कृत
 - 4. हिंदी

Q.27 2011 के 97वें संवैधानिक संशोधन अधिनियम ने _____ से संबंधित एक नया राज्य का नीति निर्देशक सिद्धांत जोड़ा।

- Ans
- 1. अर्ध-न्यायिक निकायों
 - 2. नदियों और जल निकायों
 - 3. अंतरराज्यीय संबंधों
 - 4. सहकारी समितियों

Q.28 विख्यात सिंधी सारंगी वादक लाखा खां किस राज्य के निवासी हैं?

- Ans
- 1. हरियाणा
 - 2. राजस्थान
 - 3. पंजाब
 - 4. उत्तराखंड

Q.29 Qandahar was lost to the _____ during the reign of Shah Jahan.

- Ans
- 1. Pahlavis
 - 2. Safavids
 - 3. Seljuks
 - 4. Uzbegs

Q.30 When was Rajiv Gandhi Khel Ratna Award renamed as Major Dhyan Chand Khel Ratna Award?

- Ans
- 1. 2021
 - 2. 2020
 - 3. 2022
 - 4. 2019

Q.31 Har Ghar Tiranga movement was proposed in which year's Independence Day?

- Ans
- 1. 2021
 - 2. 2020
 - 3. 2019
 - 4. 2022

Q.32 Which of the following states was selected by the Indian Government to try a new variety of wheat seeds for the first time during the green revolution?

- Ans
- 1. Punjab
 - 2. Uttar Pradesh
 - 3. Bihar
 - 4. Madhya Pradesh

Q.33 Which of the given alternatives best describes the term 'Jagati' in Nagara temple architecture?

- Ans
- 1. The raised platform in which the temple is built
 - 2. The raised platform in which the Dhwaja (flag) is planted
 - 3. The raised platform in which the Kalasha is situated
 - 4. The raised platform in which the main deities are kept

Q.34 Which of the following banks was NOT nationalised during the nationalisation of banks in 1969?

- Ans
- 1. Canara Bank
 - 2. SBI
 - 3. UCO Bank
 - 4. Bank of Baroda

Q.35 What is a criterion to define a small-scale industry?

- Ans
- 1. Size of the unit
 - 2. Maximum investment allowed on the assets of a unit
 - 3. Amount of turnover during a period of one year
 - 4. Total sales of the unit during a particular year

Q.36 Which factor contributes to the occurrence of rainfall in the north-western parts of India during winters?

- Ans
- 1. Western Disturbances
 - 2. Trade Winds
 - 3. Southwest Monsoon
 - 4. Northeast Monsoon

Q.37 The second edition of the Khelo India Winter Games 2021 was held in which of the following states/Union Territories?

- Ans
- 1. Uttarakhand
 - 2. Sikkim
 - 3. Himachal Pradesh
 - 4. Jammu and Kashmir

Q.38 इल्लुतमिश का कुतुबुद्दीन ऐबक से क्या संबंध था?

- Ans
- 1. पुत्र
 - 2. दामाद
 - 3. भाई
 - 4. बहनोई

Q.39 अनुच्छेद 166 के अनुसार किसी राज्य सरकार की समस्त कार्यपालिका कार्यवाही किसके नाम पर व्यक्त की जाएगी ?

- Ans
- 1. राज्य महाधिवक्ता
 - 2. राष्ट्रपति
 - 3. मुख्यमंत्री
 - 4. राज्यपाल

Q.40 निम्नलिखित में से कौन-सा सर्वोच्च न्यायालय के अपीलीय क्षेत्राधिकार के अंतर्गत नहीं आता है?

- Ans
- 1. संवैधानिक मामले
 - 2. केंद्र और राज्य के बीच टकराव
 - 3. आपराधिक मामले
 - 4. दीवानी मामले

Q.41 Hydrogen ions cannot exist alone, but they exist after combining with water molecules. Which of the following is the correct way to show hydrogen ions?

- Ans
- 1. H_2SO_4
 - 2. HO^-
 - 3. H_2
 - 4. H_3O^+

Q.42 The Government has launched _____ to encourage a spirit of entrepreneurship in the underserved/unserved regions of India, by providing enabling infrastructure and facilitating environment for innovation.

- Ans
- 1. One Nation One Ration Policy
 - 2. Production Linked Incentive Scheme
 - 3. Atal Community Innovation Centre Programme
 - 4. Digital Library Mission

Q.43 Globalisation is a _____ phenomenon.

- Ans
- 1. cultural only
 - 2. multi-dimensional
 - 3. uni-dimensional only
 - 4. political only

Q.44 वैजयंती काशी कौन-सी भारतीय शास्त्रीय नृत्य शैली की उन्नायक हैं?

- Ans
- 1. कुचिपुडी
 - 2. भरतनाट्यम
 - 3. ओडिसी
 - 4. मोहिनीअट्टम

Q.45 Pudukkottai Dakshinamurthi Pillai is a famous _____ player.

- Ans
- 1. flute
 - 2. kanjira
 - 3. table
 - 4. guitar

Q.46 Who among the following is a famous 'Sattriya' dancer?

- Ans
- 1. Sonal Mansingh
 - 2. Aluna Kabuini
 - 3. Mallika Sarabhai
 - 4. Sharodi Saikia

Q.47 The ocean has _____ main temperature layers.

- Ans
- 1. four
 - 2. five
 - 3. three
 - 4. two

Q.48 Which of the following statements is NOT correct about cell cycle?

- Ans
- 1. In G₂, phase cell prepare to divide.
 - 2. The correct sequence of cell cycle is G₁, S, G₂, M.
 - 3. DNA replication takes place in S cycle.
 - 4. M is a meiosis phase.

Q.49 Through which of the following Government of India Acts the Montagu-Chelmsford Reforms introduced Dyarchy in the provinces?

- Ans
- 1. 1919
 - 2. 1894
 - 3. 1858
 - 4. 1935

Q.50 In which year did the Government of India begin to establish Regional Rural Banks?

- Ans
- 1. 1975
 - 2. 1951
 - 3. 1992
 - 4. 2005

Section : Reasoning

Q.1 How many triangles are there in the given figure?

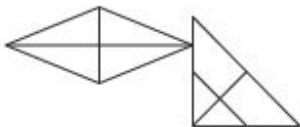

- Ans
- 1. 8
 - 2. 12
 - 3. 10
 - 4. 14

Prepare 50% Faster

Q.2 A paper is folded and cut as shown below. How will it appear when unfolded?

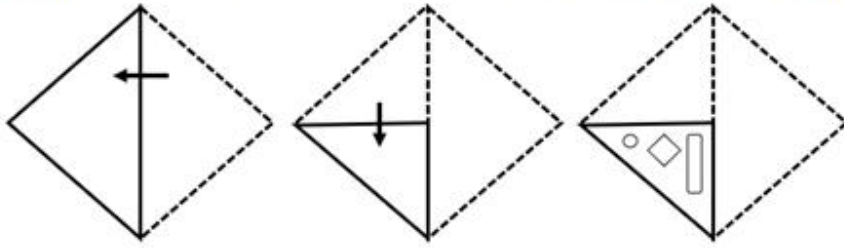

Ans

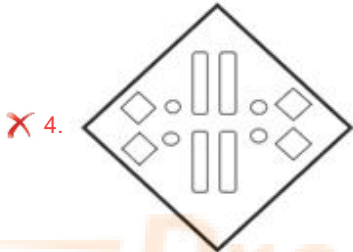
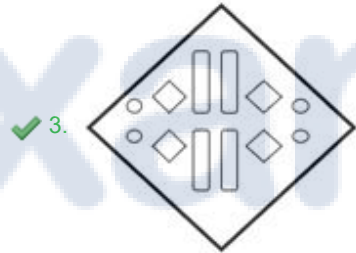
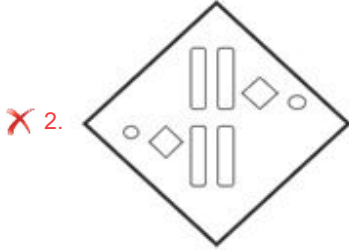
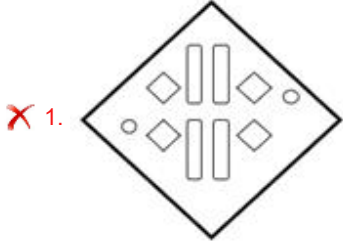

Q.3 Select the option in which the given figure is embedded. (Rotation is NOT allowed.)



Ans

✓ 1.

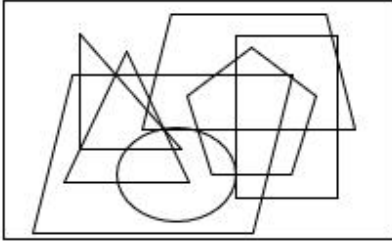

✗ 2.

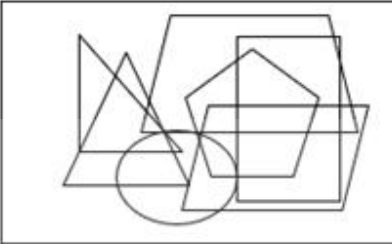

✗ 3.

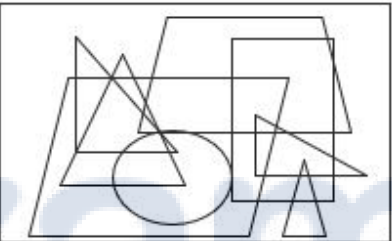

✗ 4.

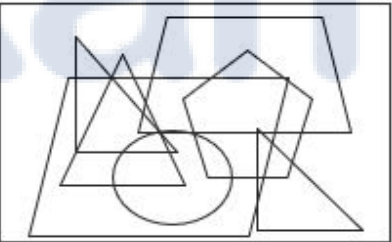

Prepare 50% Faster

Q.4 A paper is folded and cut as shown below. How will it appear when unfolded?

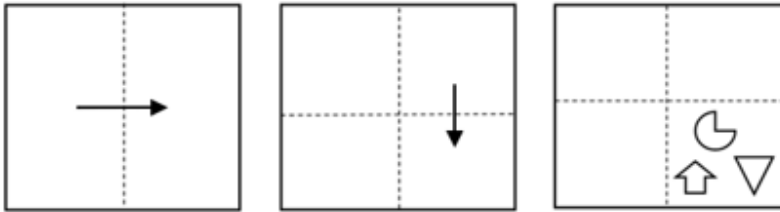

Ans

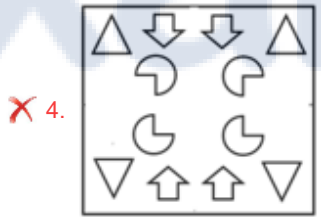
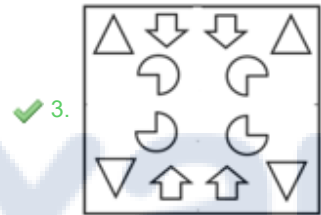
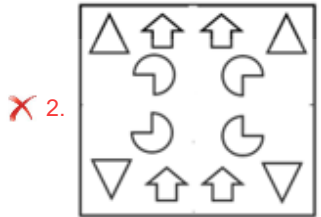
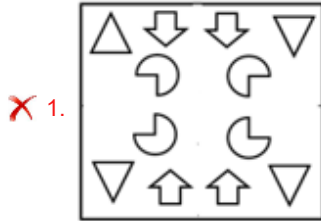

Q.5 Select the option that is related to the third term in the same way as the second term is related to the first term and the sixth term is related to the fifth term.
63 : 9 :: 84 : ? :: 119 : 17

Ans ✓ 1. 12

✗ 2. 4

✗ 3. 8

✗ 4. 16

Q.6 Select the correct combination of mathematical signs that can sequentially replace the * signs and balance the given equation.
 $12 * 6 * 3 * 2 * 8 * 4$

Ans ✗ 1. +, -, ×, ÷, =

✓ 2. ÷, -, ×, +, =

✗ 3. +, ×, -, =, ÷

✗ 4. +, ×, -, ÷, =

Q.7 Select the option in which the given figure is embedded (rotation is NOT allowed).



Ans

X 1.



X 2.

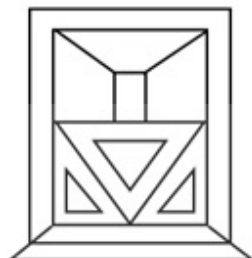

X 3.



✓ 4.

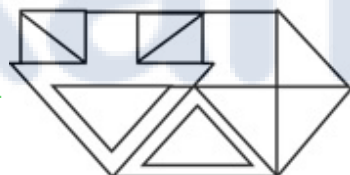

Q.8 Six people, S, T, U, V, W and X, are sitting in a straight row facing north. Only two people sit to the left of U. Only two people sit between U and X. T sits to the immediate right of S. W sits to the immediate left of V. V is not a neighbour of X. Who sits at the extreme left end of the row?

Ans ✓ 1. W

X 2. S

X 3. X

X 4. V

Q.9 Read the given statements and conclusions carefully. Assuming that the information given in the statements is true, even if it appears to be at variance with commonly known facts, decide which of the given conclusions logically follow(s) from the statements.

Statements:

- All bags are pants.
- All pants are eggs.
- All eggs are flowers.

Conclusions:

- All pants are flowers.
- All pants are bags.
- All flowers are bags.
- All flowers are pants.

Ans X 1. Only conclusion II follows

X 2. Only conclusion IV follows

✓ 3. Only conclusion I follows

X 4. Only conclusion III follows

Q.10 1, 2, 3, 4, 5 and 6 are written on different faces of a dice. Three different positions of the same dice are shown below. Find the number on the face opposite to the one showing '6'.

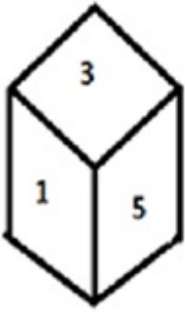

figure 1

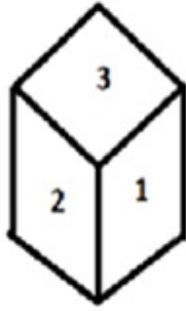

figure 2

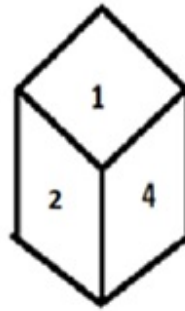

figure 3

- Ans
- 1. 5
 - 2. 4
 - 3. 1
 - 4. 2

Q.11 Select the option that is related to the third word in the same way as the second word is related to the first word. (The words must be considered as meaningful English words and must NOT be related to each other based on the number of letters/number of consonants/vowels in the word)
Chicken: Brood:: Bees:?

- Ans
- 1. League
 - 2. Mob
 - 3. Gang
 - 4. Swarm

Q.12 Select the figure from the given options that will replace the question mark (?) in the figure given below to complete the pattern.

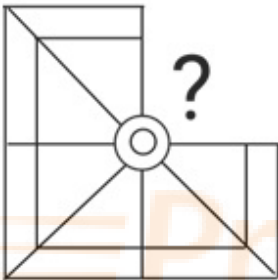

- Ans
- 1.
 - 2.
 - 3.
 - 4.

Q.13 Which figure should replace the question mark (?) if the series were to be continued?

N	9	2	9	
V 2 9 ☆	N 2	N V 9 ☆	2 V	?
☆	V	☆	N	

Ans

✗ 1.

V		
N ☆ 9		
2		

✗ 2.

V		
9 2 N		
☆		

✗ 3.

N		
V ☆ 2		
9		

✓ 4.

V		
2 N 9		
☆		

Q.14 Select the correct mirror image from the following options, when the mirror is placed on the right side of the give

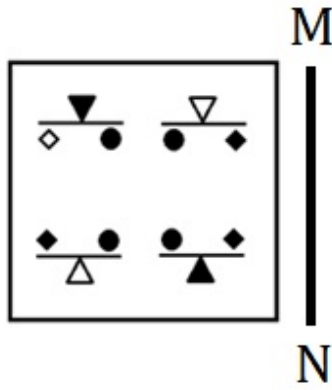

Ans

✗ 1.

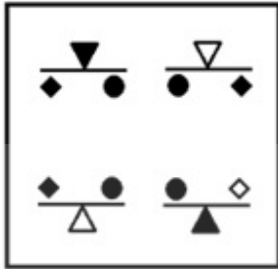

✓ 2.

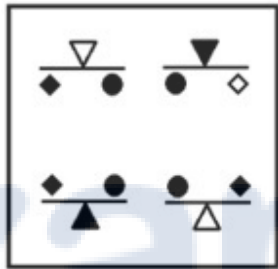

✗ 3.

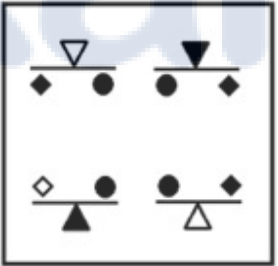

✗ 4.

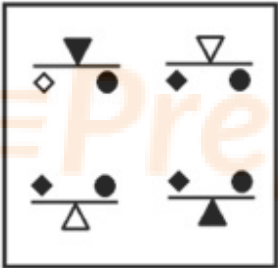

Q.15 Select the figure from among the given options that can replace the question mark (?) in the following series.

\ominus @ + ∧ &	& ∧ ≠ @ ⊖	∧ ⊖ ≠ & @	@ & ≠ ⊖ ∧	?
(i)	(ii)	(iii)	(iv)	(v)

Ans

✓ 1.

& ∧
≠
@ ⊖

✗ 2.

∞ ∧
≠
@ e

✗ 3.

∞ γ
≠
@ e

✗ 4.

∞ ∧
≠
@ ⊖

Q.16 Select the correct mirror image of the given figure when the mirror is placed at 'AB' as shown.

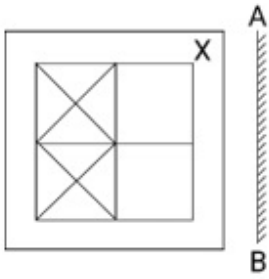

Ans

X 1.

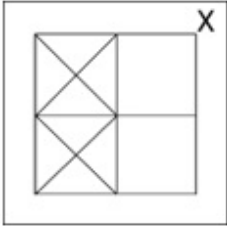

✓ 2.

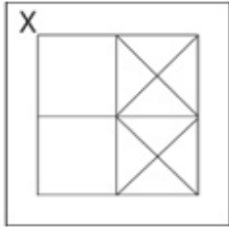

X 3.

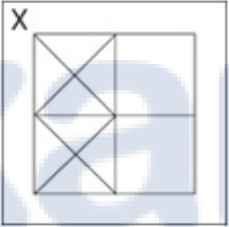

X 4.

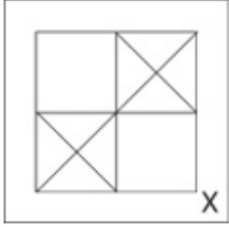

Q.17 A square sheet of paper is folded along the dotted line successively along the directions shown and is then punched last. How would the paper look when unfolded?

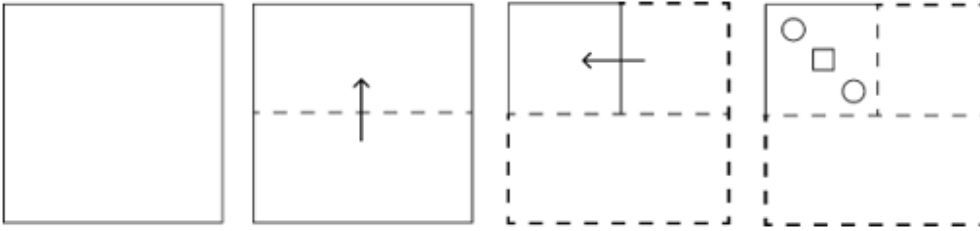

Ans

X 1.

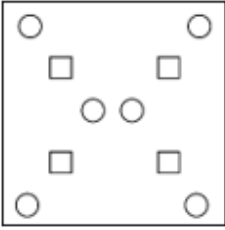

X 2.

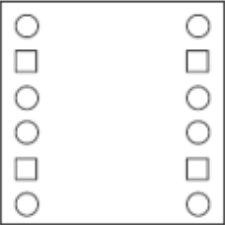

✓ 3.

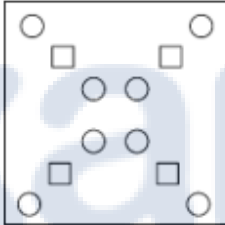

X 4.

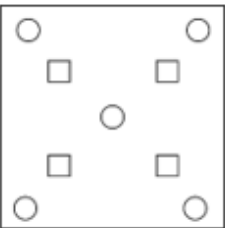

Q.18 In a certain code language, 'SITE' is written as 'WMXI' and 'MAKE' is written as 'QEOL'. How will 'TERM' be written in that language?

Ans

X 1. XHUP

X 2. WHVQ

✓ 3. XIVQ

X 4. WIUO

Q.19

Select the figure that will come next in the following figure series.

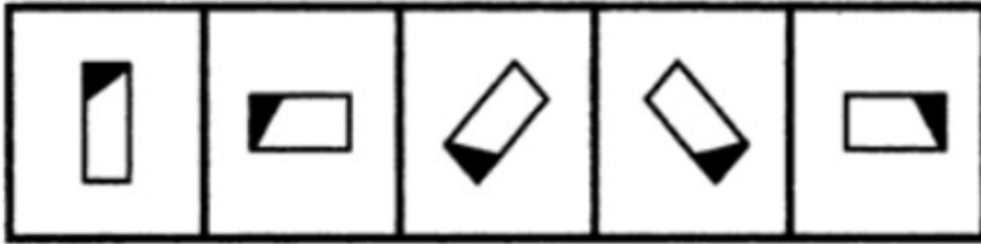

Ans

✓ 1.



✗ 2.



✗ 3.



✗ 4.

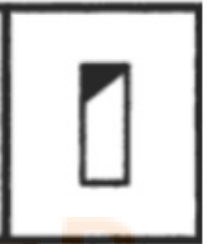

Q.20 Which two signs should be interchanged to make the following equation correct?

$$8 - 2 \times 49 \div 7 + 2 = 11$$

- Ans
- ✗ 1. - and +
 - ✗ 2. ÷ and -
 - ✗ 3. + and ×
 - ✓ 4. - and ×

Q.21 Which of the following terms will replace the question mark (?) in the given series?
BMXO, EOUM, ?, KSOI, NULG

- Ans
- ✗ 1. HORL
 - ✓ 2. HQRK
 - ✗ 3. FQSK
 - ✗ 4. FQRL

Q.22 Which of the following options will replace the question mark (?) in the given series?
286, 257, 230, 205, ?, 161

- Ans
- 1. 178
 - 2. 192
 - 3. 188
 - 4. 182

Q.23 Three different positions of the same dice are shown. Find the number on the face opposite to the face showing '6'.

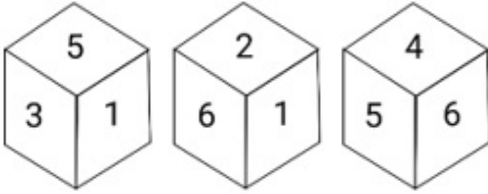

- Ans
- 1. 4
 - 2. 5
 - 3. 3
 - 4. 1

Q.24 The sequence of folding a piece of paper and the manner in which the folded paper is cut is shown in the following figure. How would this paper look when unfolded?

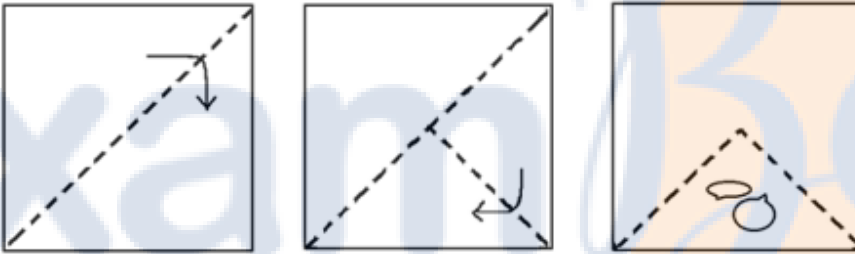

Ans

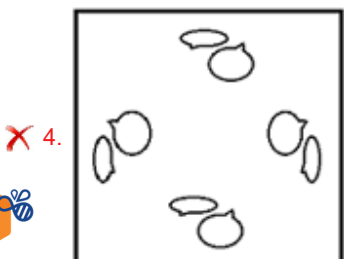
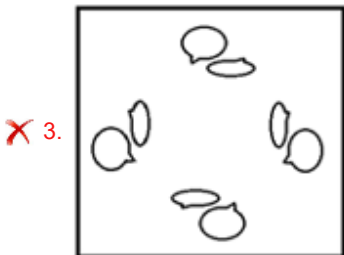
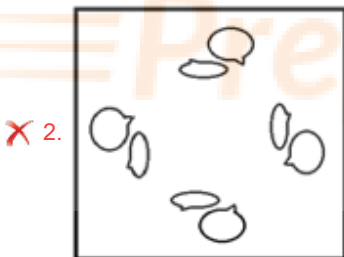
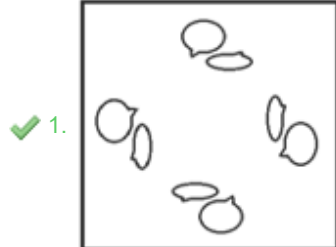

Q.25 Select the set in which the numbers are related in the same way as are the numbers of the following sets.
 (NOTE : Operations should be performed on the whole numbers, without breaking down the numbers into its con-
 digits. E.g. 13 – Operations on 13 such as adding /deleting /multiplying etc. to 13 can be performed. Breaking dov
 and 3 and then performing mathematical operations on 1 and 3 is NOT allowed)
 (676, 553), (784, 661)

- Ans
- 1. (547, 424)
 - 2. (421, 301)
 - 3. (752, 628)
 - 4. (691, 581)

Section : Numerical Ability

Q.1 If ₹10,400 is divided into three parts among P, Q and R proportional to $\frac{1}{2} : \frac{1}{5} : \frac{1}{6}$, then Q's share (in ₹) will be:

- Ans
- 1. 2,000
 - 2. 2,400
 - 3. 2,800
 - 4. 1,600

Q.2 In a school, 45% of the staff is female. 80% of the female staff and 60% of the male staff are postgraduates. Find the percentage of the non-postgraduate staff in the school.

- Ans
- 1. 42%
 - 2. 64%
 - 3. 31%
 - 4. 53%

Q.3 A positive integer is said to be prime if it is not divisible by any positive integer other than itself and one. Let K be a prime number strictly greater than 5. When K^2+19 is divided by 12, the remainder will be:

- Ans
- 1. 7
 - 2. 5
 - 3. 8
 - 4. 1

Q.4 A tower is topped by a hemispherical dome that has a surface area of 363π sq.ft approximately. Find the volume of the dome (in cubic ft).

- Ans
- 1. 724.3π
 - 2. 665.7π
 - 3. 792.7π
 - 4. 887.3π

Q.5 What is the average of 144, 169,196, 225 and 256?

- Ans
- 1. 108
 - 2. 198
 - 3. 208
 - 4. 188

Q.6 Zeeshan travelled for 40 minutes at a speed of 75 km/h and for 20 minutes at 60 km/h. Find his average speed (in km/h) during the journey.

- Ans
- 1. 70
 - 2. 72.5
 - 3. 65
 - 4. 67.5

Q.7 Two numbers are in the ratio 5 : 7. The product of their HCF and LCM is 2835. What is the sum of the numbers?

- Ans
- 1. 107
 - 2. 109
 - 3. 108
 - 4. 106

Q.8 A shopkeeper sells his goods at a 30% discount. Find the marked price of an article whose selling price is ₹1,190.

- Ans
- 1. ₹1,800
 - 2. ₹1,700
 - 3. ₹1,600
 - 4. ₹1,500

Q.9 Ramesh lent some amount of money at 12% simple interest and an equal amount of money at 15% simple interest, each for 2 years. If his total interest was ₹675, the amount lent was (lent at 12%):

- Ans
- 1. ₹1,350
 - 2. ₹1,150
 - 3. ₹1,250
 - 4. ₹1,550

Q.10 Simplify the following.

$$12 - [2.06 + \{2.57 + (9.91 - \overline{5.09 - 0.76})\}]$$

- Ans
- 1. 2.17
 - 2. 1.79
 - 3. 2.79
 - 4. 1.99

Q.11 A sum of money on compound interest becomes double of itself in 3 years. How many years will it take for the amount to become eight times of itself at the same rate of interest?

- Ans
- 1. 8
 - 2. 9
 - 3. 5
 - 4. 7

Q.12 A number is first decreased by 30% and then, increased by 40%. The resulting number is again increased by 5%. What is the net increase or decrease percentage?

- Ans
- 1. Increase of 3.4%
 - 2. Decrease of 3.4%
 - 3. Decrease of 2.9%
 - 4. Increase of 2.9%

Q.13 Komal sold two devices, each for ₹4,982. If she made 6% profit on the first and 6% loss on the second, what is the total cost of both the devices?

- Ans
- 1. ₹10,000
 - 2. ₹11,000
 - 3. ₹8,000
 - 4. ₹9,000

Q.14 If the capacity of a cylindrical tank is $14,168 \text{ m}^3$ and the diameter of its base is 28 m, then find the depth of the tank (in m).

(Take $\pi = \frac{22}{7}$)

- Ans
- 1. 32
 - 2. 27
 - 3. 23
 - 4. 30

Q.15 A is thrice as good a workman as B and is, therefore, able to finish a job in 60 days less than B. Working together, they can do it in:

- Ans
- 1. $23\frac{3}{4}$ days
 - 2. $22\frac{1}{2}$ days
 - 3. $23\frac{1}{2}$ days
 - 4. $22\frac{3}{4}$ days

Section : Computer Proficiency

Q.1 Which of the following is an effective method to handle SPAM emails?

- Ans
- 1. Reply to the sender asking them to stop
 - 2. Unsubscribe from all mailing lists
 - 3. Mark the email as SPAM or Junk
 - 4. Forward the email to all your contacts

Q.2 Which of the following is an Internet accessing technique where computer uses its modem to dial a telephone number given to the user by an Internet Service Provider?

- Ans
- 1. Digital Subscriber Line
 - 2. Integrated Services Digital Network (ISDN) Service
 - 3. Dial up Connection
 - 4. Broadband Connection

Q.3 Where is the position of the menu bar in accordance with the title bar in MS word 365?

- Ans
- 1. Menu bar is situated to the right of the title bar.
 - 2. Menu bar is situated to the left of the title bar.
 - 3. Menu bar is situated below the title bar.
 - 4. Menu bar is situated above the title bar.

Q.4 In MS Excel 365 what is the Microsoft Excel formula to create an absolute cell reference for cell B2?

- Ans
- 1. \$B2
 - 2. B\$2
 - 3. B2
 - 4. \$B\$2

Q.5 Which of the following is the most appropriate option to print pages 1, 3, 5 and so on in MS Word 365?

- Ans
- 1. Print Even pages
 - 2. Print all
 - 3. Print Odd pages
 - 4. Print

Q.6 In Microsoft Excel 365, how do you start to write a formula?

- Ans**
- 1. By typing ;
 - 2. By typing :
 - 3. By typing =
 - 4. By typing /

Q.7 Which option in Page Setup of MS word 365 determines whether the content of the document is displayed vertically or horizontally?

- Ans**
- 1. Paper Size
 - 2. Columns
 - 3. Margins
 - 4. Orientation

Q.8 In MS-Word 365, what is the primary difference between the 'Save' and 'Save As' commands?

- Ans**
- 1. Both 'Save' and 'Save As' perform the same function of saving the document; they are just two different names for the same command.
 - 2. 'Save' is used to save the document for the first time, while 'Save As' is used to save the document with a new filename or in a different location.
 - 3. 'Save' is used to save the document in the cloud storage, while 'Save As' is used to save the document on the local computer.
 - 4. 'Save' is used to save the document with a new filename or in a different location, while 'Save As' is used to save the document for the first time.

Q.9 In MS-Word 365, which action allows you to replace a specific word or phrase throughout the entire document?

- Ans**
- 1. Find and Replace
 - 2. Paste
 - 3. Cut
 - 4. Copy

Q.10 In MS Excel 365 what is the cell address of the cell two columns to the right and three rows down from cell D7?

- Ans**
- 1. G10
 - 2. F10
 - 3. F9
 - 4. E9

Prepare 50% Faster

Constable Executive Male and Female in Delhi Police Examination 2023

Exam Date	16/11/2023
Exam Time	9:00 AM - 10:30 AM
Subject	Constable Executive Male and Female in Delhi Police Examination 2023

Section : General Knowledge

Q.1 The Tungabhadra, the Koyana and the Bhima are major tributaries of which Peninsular river?

- Ans**
- 1. Kaveri
 - 2. Krishna
 - 3. Godavari
 - 4. Narmada

Q.2 वर्ष 1961 में एक बड़ा ब्रिटिश ऑर्केस्ट्रा का संचालन करने वाले पहले भारतीय निम्नलिखित में से कौन थे? वे इज़राइल फिलहारमोनिक ऑर्केस्ट्रा (Israel Philharmonic Orchestra) के 'म्यूजिक डायरेक्टर फॉर लाइफ' ('Music Director for Life) थे।

- Ans**
- 1. डॉ. लक्ष्मीनारायण सुब्रमण्यम
 - 2. ए आर रहमान
 - 3. जुबिन मेहता
 - 4. इलैया राजा

Q.3 Murad Ali is a well-known _____ player.

- Ans**
- 1. flute
 - 2. guitar
 - 3. tabla
 - 4. sarangi

Q.4 The Indian Vice President is elected by an electoral college comprising members of _____.

- Ans**
- 1. Lok Sabha and State Legislature
 - 2. Rajya Sabha and State Legislative Assembly
 - 3. Rajya Sabha, Lok Sabha and State Legislative Council
 - 4. both the houses of Parliament

Q.5 Harmika is a _____ Buddhist railing, from which a shaft rises and that holds the imperial umbrella.

- Ans**
- 1. cylindrical
 - 2. rectangular
 - 3. square
 - 4. circular

Q.6 The term 'Takshan' in the Vedic period was used for _____.

- Ans**
- 1. Rathakara
 - 2. Senani
 - 3. Carpenter
 - 4. Kulapa

Q.7 Which of the following is an essential feature of the Green Revolution?

- Ans**
- 1. Increase in the role and responsibility of the government.
 - 2. Increase in multi-fold international trade.
 - 3. Good quality labour can increase industrial productivity.
 - 4. HYV seeds have led to a substantial rise in crop productivity.

Q.8 General Agreement on Tariffs and Trade was formalised in the year:

- Ans**
- 1. 2002
 - 2. 1995
 - 3. 1947
 - 4. 1991

Q.9 Which of the following is causative factor for oral cancer?

- Ans**
- 1. Excess salt
 - 2. Tobacco
 - 3. Spicy food
 - 4. Sugar

Q.10 The main objective of which of the following schemes is to support sustainable production in the agriculture sector by providing financial assistance to farmers suffering crop loss/damage arising out of unforeseen events?

- Ans**
- 1. Pradhan Mantri Krishi Sinchai Yojana
 - 2. Pradhan Mantri Fasal Bima Yojana
 - 3. Gramin Bhandaran Yojana
 - 4. Paramparagat Krishi Vikas Yojana

Q.11 The branch of geology exploring how rocks bend in reaction to forces within the Earth's interior is called:

- Ans**
- 1. rock geology
 - 2. mountain geology
 - 3. structural geology
 - 4. basic geology

Q.12 The 'slash and burn' agriculture is known as _____ in Rajasthan state.

- Ans**
- 1. Roca
 - 2. Walthre
 - 3. Podu
 - 4. Dipa

Q.13 Which of the following has NOT occurred after the liberalisation of economic policies under the New Economic Policies (NEP) in 1991?

- Ans**
- 1. Increase in India's share of exports in world trade
 - 2. Increase in inflows from foreign direct investment
 - 3. A massive increase in the share of agriculture in India's gross domestic product
 - 4. Significant increase in India's foreign exchange reserves

Q.14 The Rajya Sabha should consist of NOT more than _____ members.

- Ans**
- 1. 238
 - 2. 250
 - 3. 240
 - 4. 245

Q.15 How many total jumps are there in a 3000 m steeplechase race?

- Ans
- 1. 35
 - 2. 33
 - 3. 34
 - 4. 36

Q.16 In which town of India did James Prinsep conduct the census in 1824?

- Ans
- 1. Allahabad
 - 2. Calcutta
 - 3. Banaras
 - 4. Bombay

Q.17 In which of the following years was Subash Chandra Bose appointed as the President of the Indian Independence League?

- Ans
- 1. 1941
 - 2. 1943
 - 3. 1942
 - 4. 1944

Q.18 How many types of ministers are there in the Council of Ministers?

- Ans
- 1. 6
 - 2. 3
 - 3. 5
 - 4. 4

Q.19 Beti Bachao, Beti Padhao Yojana is a campaign under the Government of India that was established for generating awareness and improving the efficiency of the welfare services intended for _____ in India.

- Ans
- 1. girls
 - 2. both boys and girls
 - 3. children
 - 4. boys

Q.20 In India, the Young Men's Christian Association (YMCA) at _____ introduced basketball for the first time.

- Ans
- 1. Ranchi
 - 2. Kolkata
 - 3. Mumbai
 - 4. Jamshedpur

Q.21 The 'Shiksha Karmi' initiative and the 'Lok Jumbish' programme are schemes that helped increase the literacy rate of which state in India?

- Ans
- 1. Gujarat
 - 2. Madhya Pradesh
 - 3. Mizoram
 - 4. Rajasthan

Q.22 Which of the following is NOT a fundamental duty?

- Ans
- 1. To promote cooperative society
 - 2. To safeguard public property
 - 3. To uphold and protect the sovereignty, unity and integrity of India
 - 4. To value and preserve the rich heritage of the country's composite culture

Q.23 Which of the following Articles of the Indian Constitution is related with organisation of village panchayats?

- Ans
- 1. Article 37
 - 2. Article 40
 - 3. Article 38
 - 4. Article 39

Q.24 मुहम्मद बिन तुगलक ने इब्र बतूता को दिल्ली में _____ के पद पर नियुक्त किया।

- Ans
- 1. अमलगुज़र
 - 2. शिकदार
 - 3. कोतवाल
 - 4. काज़ी

Q.25 What is the range of mesosphere?

- Ans
- 1. 50-80 km
 - 2. 10-30 km
 - 3. 0-10 km
 - 4. 50-100 km

Q.26 Identify the FALSE statement(s).

- A. In the context of Green Revolution HYV stands for Hybrid Yielding Variety.
B. Fallowing is a practice of leaving land uncultivated for some time for it to regain its fertility.

- Ans
- 1. Only A
 - 2. Neither A nor B
 - 3. Both A and B
 - 4. Only B

Q.27 सुल्तान मुहम्मद बिन तुगलक ने _____, जो एक शराब बनाने वाला था, को दिल्ली सल्तनत में एक उच्च प्रशासनिक पद पर नियुक्त किया था।

- Ans
- 1. अज़ीज़ ख़ुम्मर (Aziz Khummar)
 - 2. फ़िरोज़ हज्जाम (Firuz Hajjam)
 - 3. लाधा (Ladha)
 - 4. मनका तब्बाख़ (Manka Tabbakh)

Q.28 प्रत्येक कबड्डी मैच की देखरेख के लिए कितने अधिकारी होते हैं?

- Ans
- 1. 6
 - 2. 2
 - 3. 5
 - 4. 3

Q.29 Which Article of the Constitution of India says that Directive Principles of State Policy are fundamental in the governance of the country and it shall be the duty of the state to apply these in making laws?

- Ans
- 1. Article 37
 - 2. Article 35
 - 3. Article 39
 - 4. Article 38

Q.30 Who among the following was the founder and director of 'Darpana Academy of Performing Arts' in Ahmedabad that trains students in dance, drama, music and puppetry?

- Ans
- 1. Shovana Narayan
 - 2. Sonal Mansingh
 - 3. Padma Subrahmanyam
 - 4. Mrinalini Sarabhai

Q.31 In which year did the sepoy revolt take place in Vellore?

- Ans
- 1. 1824 CE
 - 2. 1806 CE
 - 3. 1795 CE
 - 4. 1856 CE

Q.32 Which of the following states is associated with the devotional folk dance 'Gambhira'?

- Ans
- 1. Bihar
 - 2. Rajasthan
 - 3. Odisha
 - 4. West Bengal

Q.33 The Five Kingdom Classification of living organism was first proposed by:

- Ans
- 1. RH Whittaker
 - 2. Aristotle
 - 3. Charles Darwin
 - 4. James A White

Q.34 Which of the following is NOT an independent constitutional body according to the Indian Constitution?

- Ans
- 1. State Public Service Commission
 - 2. UPSC
 - 3. Election Commission
 - 4. NITI Aayog

Q.35 Shri Narayana Guru, who belonged to the Ezhava caste, started his social reform movement in the modern state of:

- Ans
- 1. Odisha
 - 2. Maharashtra
 - 3. Punjab
 - 4. Kerala

Q.36 Which of the following statements is/are true about NABARD?

- I. NABARD was formed on the recommendation of Sivaraman Committee.
- II. NABARD came into existence in 1980.
- III. It was set up with an initial capital of ₹100 crore.

- Ans
- 1. Only II and III
 - 2. Only I and III
 - 3. Only I
 - 4. Only II

Q.37 Microfinance programmes were first created by Nobel prize winning Economist Muhammd Yunus in what decade?

- Ans
- 1. 1960s
 - 2. 1970s
 - 3. 1950s
 - 4. 1990s

Q.38 Who is the author of 'Half Girlfriend and One Indian Girl'?

- Ans
- 1. Amit Chaudhuri
 - 2. Kiran Desai
 - 3. Chetan Bhagat
 - 4. Jeet Thayil

Q.39 The Thanksgiving Festival of Nawala that is dedicated to Lord Shiva is majorly celebrated in which city of Himachal Pradesh?

- Ans
- 1. Dharamshala
 - 2. Shimla
 - 3. Kangra
 - 4. Chamba

Q.40 Fugdi dance is commonly performed during which of these festivals?

- Ans
- 1. Navratri
 - 2. Deepawali
 - 3. Holi
 - 4. Ganesh Chaturthi

Q.41 Humayun Tomb, which is located in _____ is an example of Mughal architecture inspired by Persian architecture.

- Ans
- 1. Hyderabad
 - 2. Delhi
 - 3. Bengaluru
 - 4. Jaipur

Q.42 Which thermostable enzyme hydrolyses starch during the cooking of sweet potatoes?

- Ans
- 1. Pectinase
 - 2. Lipase
 - 3. β -amylase
 - 4. Exocellulases

Q.43 As per Census 2011, which of the following states has the highest percentage of Scheduled Tribe population in the country?

- Ans
- 1. Uttar Pradesh
 - 2. Madhya Pradesh
 - 3. Nagaland
 - 4. Mizoram

Q.44 Birsa Munda hockey stadium is situated in _____ .

- Ans
- 1. Chhattisgarh
 - 2. Odisha
 - 3. Haryana
 - 4. Jharkhand

Q.45 At which place did the Congress declare the resolution of Purna Swaraj in its session in 1929?

- Ans
- 1. Karachi
 - 2. Madras
 - 3. Lahore
 - 4. Bombay

Q.46 Who described Archimedes' method of finding the specific gravity of substances using a balance in the treatise 'The Little Balance'?

- Ans
- 1. Daniel Bernoulli
 - 2. Galileo Galilei
 - 3. Albert Einstein
 - 4. Michael Faraday

Q.47 Harshavardhana, the ruler of Kannauj in 7th century CE, was the king of which of the following dynasties?

- Ans**
- 1. Pushyabhuti
 - 2. Vakataka
 - 3. Chalukya
 - 4. Maukhari

Q.48 Where is the National Flag hoisted by the Prime Minister on every Independence Day?

- Ans**
- 1. India Gate
 - 2. Parliament House
 - 3. Red Fort
 - 4. Gateway of India

Q.49 Nongkrem and Laho are the popular dances of which of the following states?

- Ans**
- 1. Arunachal Pradesh
 - 2. Assam
 - 3. Manipur
 - 4. Meghalaya

Q.50 Who among the following is an American tennis player who wrote 'Open: An autobiography'?

- Ans**
- 1. Ivan Lendl
 - 2. Pete Sampras
 - 3. Andre Agassi
 - 4. Rod Laver

Section : Reasoning

Q.1 Select the option figure that will replace the question mark (?) in the figure given below to complete the pattern.  Prepare 50% Faster

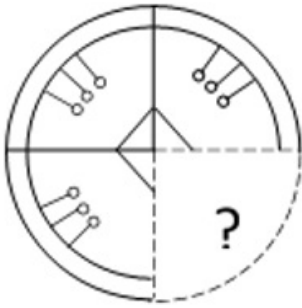

Ans

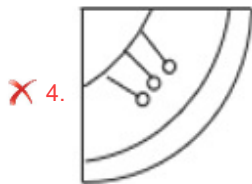
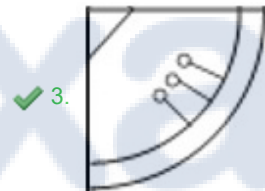
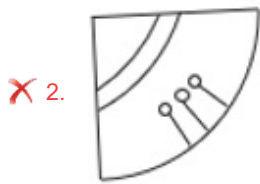
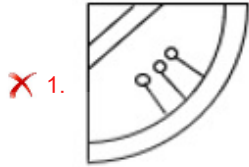

 Prepare 50% Faster

Q.2 Select the figure from the given options that will replace the question mark (?) in the figure given below and complete the pattern.

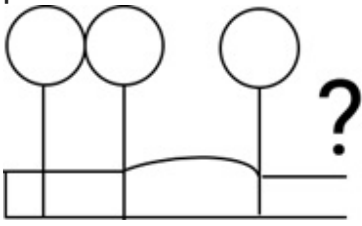

Ans

- 1.
- 2.
- 3.
- 4.

Q.3 Select the correct mirror image of the given figure when the mirror is placed at MN as shown below.

P e N t a 2 4

M _____ N

- 1. **b e N t a 2 4**
- 2. **b e N t a 2 4**
- 3. **p e N t a 2 4**
- 4. **b e N t a 2 4**

Q.4 In a certain code language, 'BLESSING' is written as 'ELJQQFJZ' and 'OVERNIGHT' is written as 'RFEJLPFTP'. How will 'HAMPER' be written in that language?

- 1. **PFNKBF**
- 2. **TBORJE**
- 3. **FBKNFP**
- 4. **QFNNBJ**

Q.5 Select the correct combination of mathematical signs to sequentially replace the * signs and to balance the given equation.

$$98 * 49 * 7 * 74 * 55 * 3$$

- Ans
- 1. ÷, -, +, ×, =
 - 2. -, ÷, +, ×, =
 - 3. -, ÷, +, =, ×
 - 4. ÷, -, ×, +, =

Q.6 L, M, N, O, P, R and S are sitting in a straight row, facing north. O is exactly between L and N. M is exactly between S and P. Only two people sit to the left of O. Who among the following sits at the extreme left end of the row?

- Ans
- 1. S
 - 2. L
 - 3. P
 - 4. R

Q.7 Select the correct mirror image of the given combination when the mirror is placed at 'PQ' as shown below.



- Ans
- 1. R S M U P Q G
 - 2. R S M U P Q G
 - 3. R S M U P Q G
 - 4. G P U M S R

Q.8 Select the correct mirror image of the given figure when the mirror is placed at PQ as shown below.

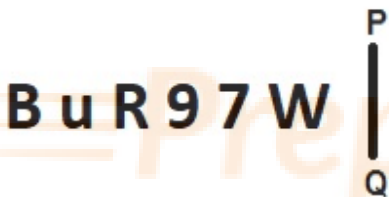

- Ans
- 1. W 7 9 R u B
 - 2. W 7 9 R u B
 - 3. W 7 9 R u B
 - 4. W 7 9 R u B

Q.9 Select the set in which the numbers are related in the same way as are the numbers of the following sets.

(NOTE : Operations should be performed on the whole numbers, without breaking down the numbers into its constituent digits. E.g. 13 – Operations on 13 such as adding /deleting /multiplying etc. to 13 can be performed. Breaking down 13 into 1 and 3 and then performing mathematical operations on 1 and 3 is not allowed.)

(63, 9, 27)
(105, 15, 45)

- Ans
- 1. (147, 21, 63)
 - 2. (147, 21, 65)
 - 3. (149, 21, 63)
 - 4. (149, 21, 65)

Q.10 Select the figure that will come next in the following figure series.

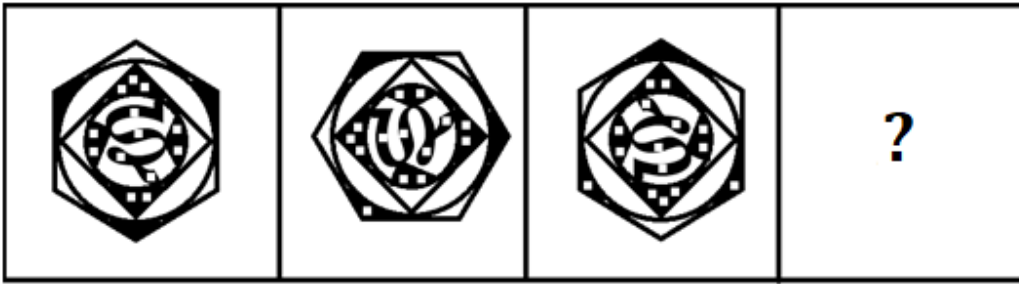

Ans



Q.11 Three different positions of the same dice are shown. Select the symbol that will be on the face opposite to the face showing 'L'.

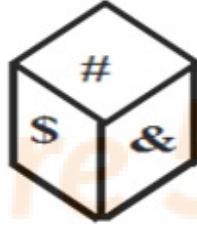
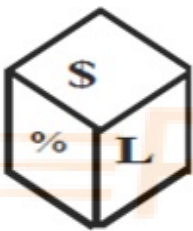

- Ans
- ✗ 1. &
 - ✗ 2. %
 - ✗ 3. @
 - ✓ 4. #

Q.12 Which figure should replace the question mark (?) if the series were to be continued?

S	C	C	S	V	C	C	V	
X	=	9	V	X	=	X	=	S
V		↑	↑	9	9	↑	↑	S
								?

Ans

✓ 1.

9	C
X	=
S	↑

✗ 2.

V	=
C	9
S	↑

✗ 3.

V	C
X	=
S	↑

✗ 4.

V	C
=	9
S	↑

Q.13 Which of the following option figures will complete the pattern in the figure given below?



Ans

X 1.



X 2.



✓ 3.



X 4.



Q.14 Three different positions of the same dice are shown. Find the number on the face opposite the face showing '2'.

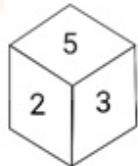
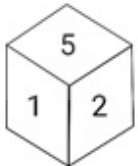

Ans

X 1. 1

X 2. 5

X 3. 3

✓ 4. 4

Q.15 Select the option that is related to the fifth letter cluster in the same way as the second letter cluster is related to the first letter cluster.
RJCZ : KPVF :: DJVE : WPOK :: PGCS : ?

Ans

X 1. LKSP

X 2. MCJA

✓ 3. IMVY

X 4. YGBE

Q.16 How many triangles are there in the given figure?

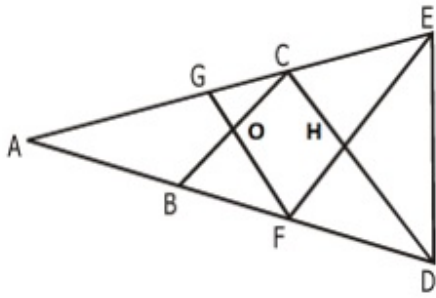

- Ans
- 1. 20
 - 2. 13
 - 3. 14
 - 4. 17

Q.17 Which two signs should be interchanged to make the given equation correct?

$$264 \div 4 \times 7 = 87 - 370 + 5$$

- Ans
- 1. = and ×
 - 2. = and ÷
 - 3. = and -
 - 4. = and +

Q.18 Select the correct mirror image of the given combination when the mirror is placed at 'XY' as shown below.



- Ans
- 1. 642LATIPAC
 - 2. CAPI1A1246
 - 3. CAPITAL246
 - 4. CAPITAL246

Q.19 Select the number from among the given options that can replace the question mark (?) in the following series.

10, 18, 42, 114, 330, ?

- Ans
- 1. 876
 - 2. 678
 - 3. 545
 - 4. 978

Q.20 When the given figure is folded to form a cube, then which face will be on the opposite plane of 4?

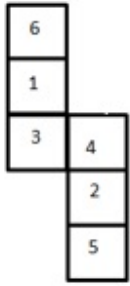

- Ans
- 1. 6
 - 2. 3
 - 3. 5
 - 4. 1

Q.21 Given below is a series of figures – A, B, C and D which follow a particular pattern. Which of the given option figures should come in place of E to continue the series?



- Ans
- 1.
 - 2.
 - 3.
 - 4.

Q.22 Select the option that is related to the fourth number in the same way as the first number is related to the second number and the fifth number is related to the sixth number.
1260 : 1890 :: ? : 2160 :: 1882 : 2823

- Ans
- 1. 1480
 - 2. 1440
 - 3. 1280
 - 4. 1860

Q.23 Select the correct mirror image of the given figure when the mirror is placed at MN as shown below.

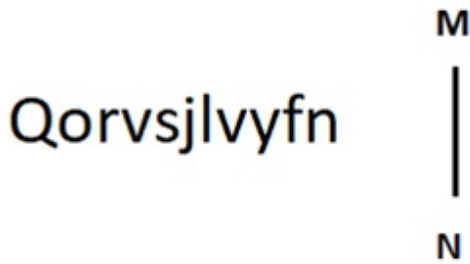

Ans

- 1. $\sigma\omicron\iota\lambda\sigma\iota\lambda\upsilon\lambda\tau\mu$
- 2. $\sigma\tau\iota\lambda\upsilon\lambda\sigma\iota\lambda\upsilon\lambda\tau\mu$
- 3. $\sigma\tau\iota\lambda\upsilon\lambda\sigma\iota\lambda\upsilon\lambda\tau\mu$
- 4. $\mu\tau\iota\lambda\upsilon\lambda\sigma\iota\lambda\upsilon\lambda\tau\mu$

Q.24 Which of the following letter clusters will replace the question mark (?) in the given series to make it logically complete?
IKN, GHL, EEJ, CBH, ?

Ans

- 1. AYF
- 2. AZF
- 3. AYE
- 4. AXE

Q.25 Two statements are given, followed by two conclusions numbered I and II. Assuming the statements to be true, even if they seem to be at variance with commonly known facts, decide which of the conclusions logically follow(s) from the statements.

Statements:

All surveys are research.

Some surveys are books.

Conclusions:

I. Some research are surveys.

II. All books are research.

Ans

- 1. Both Conclusions I and II follow.
- 2. Only Conclusion I follows.
- 3. Only Conclusion II follows.
- 4. Neither Conclusion I nor II follows.

Section : Numerical Ability

Q.1 A person buys a car at 25% discount on the marked price and sells it at 20% higher than the marked price. What is the actual gain percentage?

Ans

- 1. 20%
- 2. 25%
- 3. 40%
- 4. 60%

Q.2 The area of a triangle whose sides are of lengths 5 cm, 6 cm and 8 cm is:

Ans

- 1. 14.98 cm^2
- 2. 18.92 cm^2
- 3. 16.89 cm^2
- 4. 10.92 cm^2

Q.3 A has completed two-third of a job in 8 days, and B completes the rest of the job in 20 days. In how many days can they together complete the job?

- Ans
- 1. 8
 - 2. 10
 - 3. 20
 - 4. 12

Q.4 Venu invested a certain amount in shares. The shares rose by 25% on the first day, fell by 8% on the second day and fell by 10% the next day. The percentage profit or loss made by Venu is:

- Ans
- 1. 4.5%, profit
 - 2. 4.5%, loss
 - 3. 3.5%, loss
 - 4. 3.5%, profit

Q.5 A 300 m long train crosses a platform which is five times of its length, in 7 minutes 40 sec. What is the speed of the train?

- Ans
- 1. $3\frac{21}{23}$ m/s
 - 2. $1\frac{17}{23}$ m/s
 - 3. $2\frac{17}{23}$ m/s
 - 4. $2\frac{19}{23}$ m/s

Q.6 Let y be 20% more than x . If the same number is added to x and y , then x becomes $\frac{3}{2}$ times its previous value. Now the new value of y is _____ times its previous value.

- Ans
- 1. $\frac{21}{17}$
 - 2. $\frac{12}{17}$
 - 3. $\frac{19}{17}$
 - 4. $\frac{17}{12}$

Q.7 The simple Interest becomes $\frac{3}{4}$ of the sum invested in 15 years. What is the rate of interest if the sum invested is ₹20,000?

- Ans
- 1. 4%
 - 2. 7%
 - 3. 5%
 - 4. 6%

Q.8 Twin prime numbers are the prime numbers whose difference is always equal to 2. The number of twin primes between 100 and 1000 is:

- Ans
- 1. 2
 - 2. 3
 - 3. 1
 - 4. 4

Q.9 Three numbers which are co-prime to each other are such that the product of the first two is 391 and that of the last two is 943. Find the middle number.

- Ans
- 1. 19
 - 2. 41
 - 3. 17
 - 4. 23

Q.10 A sum of ₹9,500 becomes ₹11,704.95 in 2 years at compound interest. What is the rate of interest?

- Ans
- 1. 9%
 - 2. 7%
 - 3. 11%
 - 4. 10%

Q.11 The radius and height of a cone are 4 cm and 3 cm, respectively. Find the volume of the cone.

- Ans
- 1. $8\pi \text{ cm}^3$
 - 2. $48\pi \text{ cm}^3$
 - 3. $16\pi \text{ cm}^3$
 - 4. $12\pi \text{ cm}^3$

Q.12 What is the smallest number which, when divided by 15, 17 and 19, leaves remainder 4, 6 and 8, respectively?

- Ans
- 1. 4548
 - 2. 4845
 - 3. 4834
 - 4. 4832

Q.13 If Ram gets a discount of 12% on the marked price of a fan, he saves ₹600. How much did Ram pay for the fan?

- Ans
- 1. ₹4,400
 - 2. ₹3,300
 - 3. ₹3,600
 - 4. ₹4,600

Q.14 If $3x : y : 2z = 6 : 5 : 4$ and $5x - 3y + 4z = 48$, then find the value of $2z$.

- Ans
- 1. 60
 - 2. 48
 - 3. 64
 - 4. 54

Q.15 What is the average of the following numbers?

4, 3, 7, -3, 0, -5, -7, 5, -6, 0, -4, 6

- Ans
- 1. 2
 - 2. 4
 - 3. 1
 - 4. 0

Q.1 Which of the following devices is most commonly used to connect multiple computers within a Local Area Network and also efficiently manage data traffic by only sending data to the device it is intended for?

- Ans
- 1. Modem
 - 2. Switch
 - 3. Router
 - 4. Gateway

Q.2 What is the purpose of the 'Center Align' text alignment option in Microsoft Word 365?

- Ans
- 1. It aligns the text along the right margin
 - 2. It aligns the text along the left margin
 - 3. It adds extra spacing between words
 - 4. It centres the text horizontally between the margins

Q.3 In MS Excel 365, which cell reference type allows the cell reference in the formula to reflect the new location after a formula is copied and pasted to another cell?

- Ans
- 1. Absolute cell reference
 - 2. Circular cell reference
 - 3. Mixed cell reference
 - 4. Relative cell reference

Q.4 Which of the following shortcut keys is used to open the help tab in the menu bar in MS Word 365?

- Ans
- 1. F4
 - 2. F2
 - 3. F12
 - 4. F1

Q.5 How can you delete a row or column in MS-Excel 365?

- Ans
- 1. Go to the 'Insert' tab on the Excel ribbon and click on 'Delete'.
 - 2. Right-click on the row or column and choose 'Delete' from the context menu.
 - 3. Use the Ctrl+H keyboard shortcut.
 - 4. Use the Ctrl+D keyboard shortcut.

Q.6 In MS Word 365 how can you access the spelling and grammar check feature in Microsoft Word?

- Ans
- 1. Go to the 'Home' tab and click on 'Spelling & Grammar'
 - 2. Go to the 'Insert' tab and click on 'Spelling & Grammar'
 - 3. Go to the 'Review' tab and click on 'Spelling & Grammar'
 - 4. Go to the 'View' tab and click on 'Spelling & Grammar'

Q.7 How do you access the 'Save As' function in MS Word 365?

- Ans
- 1. By clicking on the 'Save' icon
 - 2. By using the keyboard shortcut 'Ctrl + S'
 - 3. By right-clicking on the document and selecting 'Save As'
 - 4. By going to the File tab and selecting 'Save As'

Q.8 In MS-Excel 365, which option allows you to sort data based on multiple columns simultaneously?

- Ans
- 1. Quick Sort
 - 2. Sort A to Z
 - 3. AutoFilter
 - 4. Custom Sort

Q.9 The symbol which is used to separate the user name and email server parts of an email is:

- Ans**
- 1. #
 - 2. @
 - 3. %
 - 4. \$

Q.10 Which of the following tabs on the ribbon in MS Word 365 provides options for formatting text, such as font style and size?

- Ans**
- 1. Insert
 - 2. Page Layout
 - 3. File
 - 4. Home



Prepare 50% Faster

Constable Executive Male and Female in Delhi Police Examination 2023

Exam Date	16/11/2023
Exam Time	12:00 PM - 1:30 PM
Subject	Constable Executive Male and Female in Delhi Police Examination 2023

Section : General Knowledge

Q.1 What are the paired organs of balance commonly found in aquatic invertebrates which are usually fluid-filled vesicles with sensory hairs?

- Ans**
- 1. Radula
 - 2. Pharynx
 - 3. Statocysts
 - 4. Nephridia

Q.2 Public Distribution System was relaunched by Government of India as _____ in 1997.

- Ans**
- 1. Targeted People Distribution System
 - 2. Cooperative Public Distribution System
 - 3. Public Food Distribution System
 - 4. Targeted Public Distribution System

Q.3 As of October 2022, fire altars are primarily found in which of the following Harappan cities?

- Ans**
- 1. Mohenjo-Daro
 - 2. Kalibangan
 - 3. Rakhigarhi
 - 4. Banawali

Q.4 In which year was Project Tiger launched in India to conserve the declining number of tigers?

- Ans**
- 1. 1981
 - 2. 1973
 - 3. 1970
 - 4. 1987

Q.5 Which Committee made recommendations for the inclusion of fundamental duties in the Indian Constitution?

- Ans**
- 1. Sardar Swaran Singh Committee
 - 2. John Mathai Committee
 - 3. PK Watal Committee
 - 4. AP Jain Committee

Q.6 Sitara Devi and Lachhu Maharaj are popular for their mastery in which of the following styles of Indian dance?

- Ans**
- 1. Kathak
 - 2. Manipuri
 - 3. Kuchipudi
 - 4. Bharatanatyam

Q.7 King Kanishka was a famous ruler of which Indian dynasty?

- Ans
- 1. Shaka
 - 2. Hind Unani
 - 3. Satavahana
 - 4. Kushan

Q.8 The maximum duration of a test match of cricket is _____ days.

- Ans
- 1. four
 - 2. five
 - 3. two
 - 4. three

Q.9 In which year was the city of Agra founded?

- Ans
- 1. 1304
 - 2. 1404
 - 3. 1504
 - 4. 1204

Q.10 The Chairman and members of the State Public Service Commission are appointed by the _____.

- Ans
- 1. State Assembly
 - 2. President of India
 - 3. Chief Minister
 - 4. Governor

Q.11 _____ is the first Indian woman to have won a Grammy.

- Ans
- 1. Monali Thakur
 - 2. Tanvi Shah
 - 3. Neha Bhasin
 - 4. Neeti Mohan

Q.12 The Afghan noble Khan Jahan Lodi rebelled against the Mughal emperor _____ and was defeated.

- Ans
- 1. Bahadur Shah
 - 2. Shah Jahan
 - 3. Muhammad Azam Shah
 - 4. Aurangzeb

Q.13 Champaner-Pavagadh Archaeological Park is situated in which of the following states of India?

- Ans
- 1. Haryana
 - 2. Rajasthan
 - 3. Bihar
 - 4. Gujarat

Q.14 Which of the following Fundamental Duties is mentioned first in the Constitution of India?

- Ans
- 1. To cherish and follow the noble ideals which inspired our national struggle for freedom
 - 2. To defend the country and render national service when called upon to do so
 - 3. To uphold and protect the sovereignty, unity and integrity of India
 - 4. To abide by the Constitution and respect its ideals and institutions, the National Flag and the National Anthem

Q.15 Which of the following will NOT be included in the estimation of national income?

- (i) Expenses on electricity by a factory
- (ii) Financial help to earthquake victims
- (iii) Imputed value of production for self-consumption
- (iv) Brokerage on sale of bonds

- Ans
- 1. All of (i), (ii), (iii) and (iv)
 - 2. Both (iii) and (iv)
 - 3. None of (i), (ii), (iii) and (iv)
 - 4. Both (i) and (ii)

Q.16 Name the autobiography written by Hillary Clinton, as an account of her eight years as the first lady of the United States.

- Ans
- 1. Express Yourself
 - 2. In the Shadow of Man
 - 3. My Life, My Truth
 - 4. Living History

Q.17 What does the E stand for in SEZ?

- Ans
- 1. Export
 - 2. Economic
 - 3. Economically
 - 4. External

Q.18 _____ grows well on well-drained fertile soils in the flood plains of India where soils are renewed every year.

- Ans
- 1. Natural silk
 - 2. Jute
 - 3. Saffron
 - 4. Bajra

Q.19 Dr. Shyama Prasad Mukherjee Swimming Pool Complex is located at:

- Ans
- 1. New Delhi
 - 2. Patiala
 - 3. Kolkata
 - 4. Bangalore

Q.20 Sultan Azlan Shah Cup is held in _____.

- Ans
- 1. India
 - 2. Malaysia
 - 3. Iran
 - 4. Indonesia

Q.21 'Lent' is a religious observance celebrated by the people who practice the _____ religion.

- Ans
- 1. Christian
 - 2. Buddhist
 - 3. Sikh
 - 4. Jain

Q.22 From which of the following years did the fourth five-year plan commence?

- Ans
- 1. 1964
 - 2. 1963
 - 3. 1966
 - 4. 1969

Q.23 Who is the first law officer of the Government of India?

- Ans
- 1. Attorney General of India
 - 2. The Advocate-General for the State
 - 3. Law Minister
 - 4. Law Commissioner

Q.24 Which of the following is NOT generally used in milk adulteration?

- Ans
- 1. Starch
 - 2. Urea
 - 3. Saw dust
 - 4. Detergent

Q.25 According to the census of India 2011, which group of states has the highest sex ratio?

- Ans
- 1. Kerala and Andhra Pradesh
 - 2. Tamil Nadu and Bihar
 - 3. Andhra Pradesh and Chhattisgarh
 - 4. Kerala and Tamil Nadu

Q.26 Who among the following was the founder of Satyashodhak Samaj, a society dedicated towards eradicating caste injustice?

- Ans
- 1. Bal Gangadhar Tilak
 - 2. Mahatma Ayyankali
 - 3. Jyotirao Govindrao Phule
 - 4. Periyar Erode Venkata Ramasamy

Q.27 Who is the head of the government among the following?

- Ans
- 1. Speaker
 - 2. Vice President
 - 3. President
 - 4. Prime Minister

Q.28 The sale of car results in _____.

- Ans
- 1. decrease in sale of final products
 - 2. no change
 - 3. decrease in GDP
 - 4. increase in GDP

Q.29 Under which Act was the Central Legislature made of two houses?

- Ans
- 1. Government of India Act, 1935
 - 2. Government of India Act, 1919
 - 3. Government of India Act, 1947
 - 4. The Indian Councils Act, 1909

Q.30 Which of the following is the hardest mineral?

- Ans
- 1. Talc
 - 2. Diamond
 - 3. Gypsum
 - 4. Calcite

Q.31 Industrial Licensing is compulsory for five industries. Which of the following is NOT one of those five industries?

- Ans**
- 1. Industrial Explosives
 - 2. Cottage Industries
 - 3. Cigarettes
 - 4. Alcohol

Q.32 What are sea salt, pollen, ash, smoke soot and fine soil associated with?

- Ans**
- 1. Water vapour
 - 2. Gases
 - 3. Meteors
 - 4. Dust particles

Q.33 Arrange the following Fundamental Duties in sequential order according to their mention in the Constitution of India.

- A. To abide by the Constitution and respect its ideals and institutions.
- B. To uphold and protect the sovereignty, unity and integrity of India.
- C. To cherish and follow the noble ideals which inspired our national struggle for freedom.
- D. To safeguard public property and to abjure violence.

- Ans**
- 1. A, D, C, B
 - 2. A, C, B, D
 - 3. B, A, D, C
 - 4. A, B, C, D

Q.34 Pradhan Mantri Kisan Maan Dhan Yojana is a government scheme meant for old age protection and social security of Small and Marginal Farmers (SMF). It provides for an assured Pension of _____.

- Ans**
- 1. ₹3,000 month
 - 2. ₹1,000 month
 - 3. ₹6,000 month
 - 4. ₹5,000 month

Q.35 Rahul decided to take a walk through a forest early in the morning. While he was inside the dense forest, he could see the beautiful sunrays through the small gaps within trees and clearly see the path taken by those rays. Of which effect was this a result?

- Ans**
- 1. Dispersion
 - 2. Reflection
 - 3. Tyndall effect
 - 4. Diffraction

Q.36 Sulochana Chavan is a celebrated _____ singer who was awarded the Padma award in 2022.

- Ans**
- 1. Sufi
 - 2. Ghazal
 - 3. Lavani
 - 4. Carnatic

Q.37 The _____ Tableau won 'People's Choice Award' at the 74th Republic Day Parade.

- Ans**
- 1. Kerala
 - 2. Tripura
 - 3. Gujarat
 - 4. Uttarakhand

Q.38 Kumaradevi, a Lichchhavi princess, was married to whom among the following Gupta kings?

- Ans
- 1. Chandragupta II
 - 2. Samudragupta
 - 3. Srigupta
 - 4. Chandragupta I

Q.39 Sangeet Natak Akademi award winner Guru Bipin Singh is a famous _____ dancer.

- Ans
- 1. Odissi
 - 2. Mohiniattam
 - 3. Manipuri
 - 4. Sattriya

Q.40 Summer Olympics 1948, when Indian hockey team won gold medal was held in which of the following cities?

- Ans
- 1. Tokyo
 - 2. Rome
 - 3. London
 - 4. Los Angeles

Q.41 Kunbi is the folk dance of which Indian state?

- Ans
- 1. Jharkhand
 - 2. Tamil Nadu
 - 3. Goa
 - 4. Bihar

Q.42 r-selected species have maximum:

- Ans
- 1. survival rate
 - 2. mortality rate
 - 3. parental care
 - 4. reproductive rate

Q.43 Who among the following social reformers was the inspiration behind the establishment of Prarthana Samaj in 1867?

- Ans
- 1. Keshab Chandra Sen
 - 2. Shiv Narayan Agnihotri
 - 3. Durgaram Mehta
 - 4. Raja Ram Mohan Roy

Q.44 Which of the following denotes the ideals that the state should keep in mind while formulating policies and enacting laws?

- Ans
- 1. Fundamental Duties
 - 2. Fundamental Right
 - 3. Directive Principles Of State Policy
 - 4. Preamble

Q.45 Natpuja dance is the folk dance of _____.

- Ans
- 1. Assam
 - 2. Bihar
 - 3. Punjab
 - 4. Uttar Pradesh

Q.46 'Food, Work and Productivity' were the focus of which Five-Year Plan?

- Ans
- 1. Fourth Five-Year Plan
 - 2. Ninth Five-Year Plan
 - 3. Fifth Five-Year Plan
 - 4. Seventh Five-Year Plan

Q.47 What is the approximate percentage of adolescents (10-19 years) in India as per Census 2011?

- Ans
- 1. 20.9%
 - 2. 24.3%
 - 3. 18.3%
 - 4. 22.6%

Q.48 'To Kill a Mockingbird', an English novel, was written by which of the following authors?

- Ans
- 1. Harper Lee
 - 2. Muriel Spark
 - 3. Doris Lessing
 - 4. Joseph Heller

Q.49 Who among the following established the Ramakrishna Mission in 1897?

- Ans
- 1. Swami Acchutananda
 - 2. Swami Shraddananda
 - 3. Swami Vivekananda
 - 4. Swami Dayananda Saraswati

Q.50 Identify the iron and steel plant that was developed in collaboration with Germany.

- Ans
- 1. Durgapur
 - 2. Salem
 - 3. Visvesvaraya
 - 4. Rourkela

Section : Reasoning

Q.1 Select the option that is related to the fourth term in the same way as the first term is related to the second term and the fifth term is related to the sixth term.
144 : 12 :: ? : 25 :: 216 : 18

- Ans
- 1. 260
 - 2. 280
 - 3. 300
 - 4. 250

Q.2 Select the number from among the given options that can replace the question mark (?) in the following series.

2, 15, 41, 93, 197, ?

- Ans
- 1. 405
 - 2. 534
 - 3. 320
 - 4. 324

Q.3 Select the set in which the numbers are related in the same way as are the numbers of the given sets.
 (NOTE: Operations should be performed on the whole numbers, without breaking down the numbers into its con:
 digits. E.g., 13 – Operations on 13 such as adding/ deleting/ multiplying etc. to 13 can be performed. Breaking do
 and 3 and then performing mathematical operations on 1 and 3 is not allowed.)
 (205, 146, 87)
 (333, 274, 215)

- Ans**
- 1. (180, 130, 71)
 - 2. (230, 181, 137)
 - 3. (188, 129, 70)
 - 4. (222, 169, 123)

Q.4 Select the option figure that is embedded in the given figure (rotation is NOT allowed).



- Ans**
- 1.
 - 2.
 - 3.
 - 4.

Q.5 Which two signs should be interchanged to make the given equation correct?
 $23 \times 7 - 76 + 87 \div 344 = 2$

- Ans**
- 1. + and ×
 - 2. ÷ and =
 - 3. × and -
 - 4. × and ÷

Q.6 A paper is folded and cut as shown below. How will it appear when unfolded?

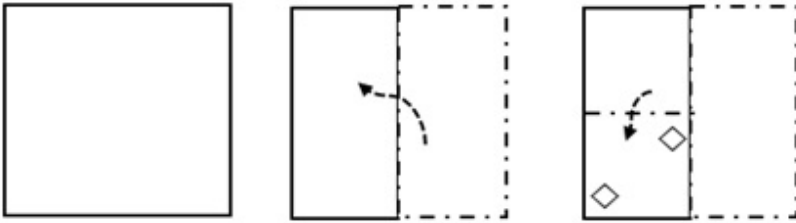

Ans

1.

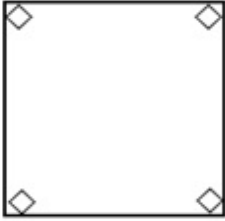

2.

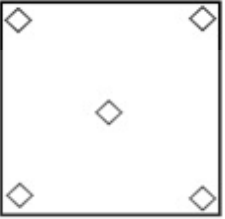

3.



4.



Q.7 Select the correct combination of mathematical signs that can sequentially replace the * signs and balance the given equation.

$$66 * 3 * 11 * 12 * 230$$

Ans 1. $\times, -, \div, =$

2. $-, \times, \div, =$

3. $\times, -, =, \div$

4. $\div, \times, -, =$

Q.8 Six letters, U, V, W, X, Y and Z are written on different faces of a dice. Three positions of this dice are shown here. Find the letter on the face opposite X.



Ans 1. U

2. W

3. Z

4. V

Q.9 The sequence of folding a piece of paper and the manner in which the folded paper has been cut is shown below figure which would most closely resemble the unfolded form of the paper.

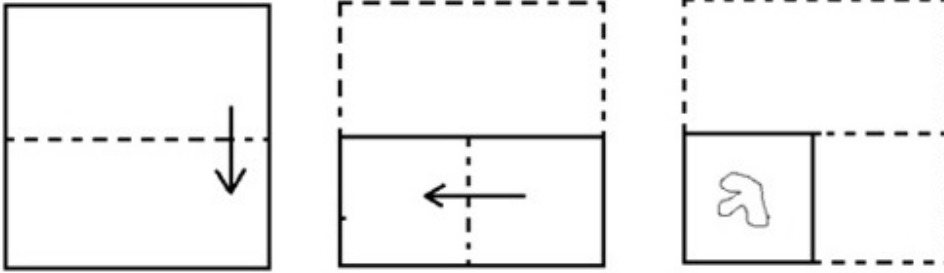

Ans

✓ 1.

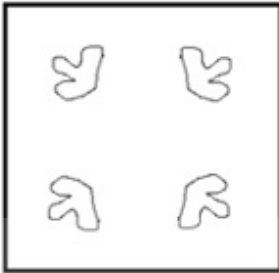

✗ 2.



✗ 3.

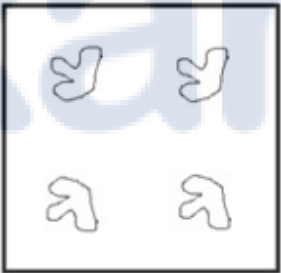

✗ 4.

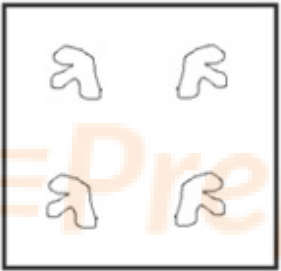

Q.10 Select the figure that will replace the question mark (?) in the following figure series.



Ans

- 1.
- 2.
- 3.
- 4.

Q.11 Select the option that is related to the fifth letter cluster in the same way as the second letter cluster is related to the first letter cluster and the fourth letter cluster is related to the third letter cluster.
EGAK : WKSO :: JRCU : BVUY :: CLAG : ?

- 1. USPC
- 2. IHAL
- 3. UPSK
- 4. IHEN

Q.12 In a code language, if SMILE is coded as RLHKD and BELIEVE is coded as ADKHDUD, then how will LAUGHTER be coded?

- 1. NCWIJVT
- 2. KZTFGSDQ
- 3. MBHVIFSU
- 4. MBVHIUFS

Q.13 How many triangles are there in the given figure?

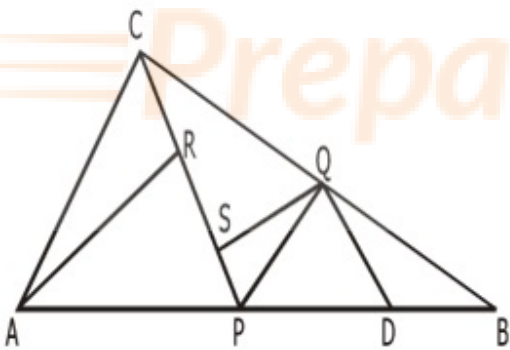

- 1. 13
- 2. 12
- 3. 10
- 4. 11

Q.14 A square sheet of paper is folded along the dotted line successively along the directions shown and is then punched last. How would the paper look when unfolded?

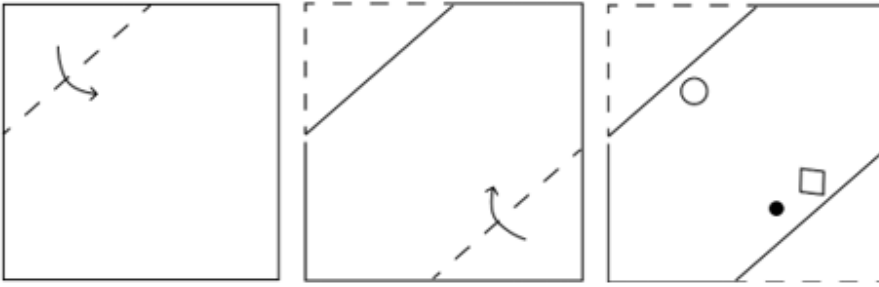

Ans

✗ 1.

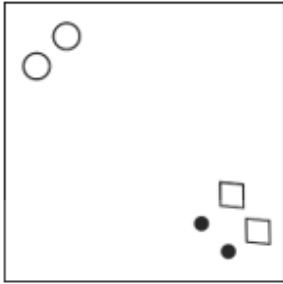

✗ 2.

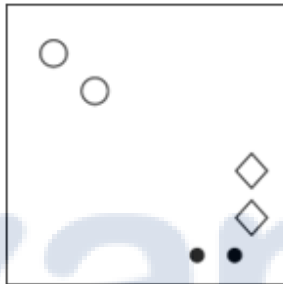

✓ 3.



✗ 4.

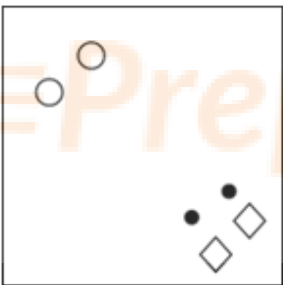

Q.15 Six letters, D, E, F, G, H and I are written on different faces of a dice. Three positions of this dice are shown here. Find the letter on the face opposite E.

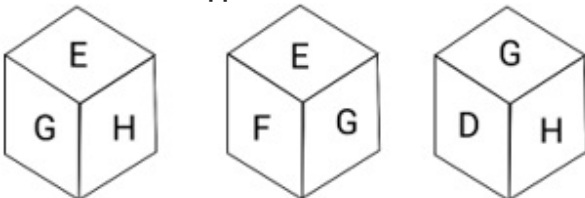

Ans

✗ 1. I

✗ 2. G

✗ 3. F

✓ 4. D

Q.16 Six letters, M, N, O, P, Q and R are written on different faces of a dice. Three positions of this dice are shown here letter on the face opposite N.



- Ans
- 1. O
 - 2. M
 - 3. R
 - 4. P

Q.17 Each of the following questions consists of 4 figures marked 1, 2, 3 and 4 called the Problem Figures followed by 4 other figures . Select a figure from amongst the Answer Figures which will continue the same series as established by the four Problem Figures.

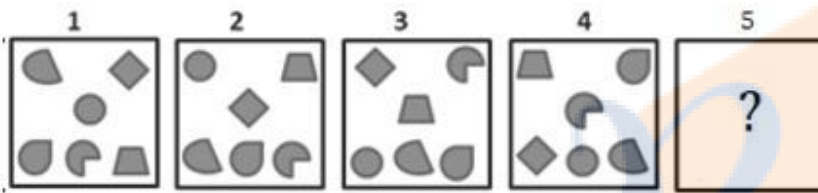

- Ans
- 1.
 - 2.
 - 3.
 - 4.

Q.18 A paper is folded and cut as shown below. How will it appear when unfolded?

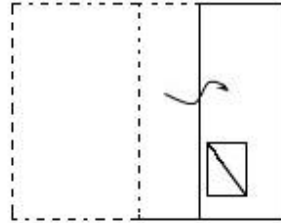
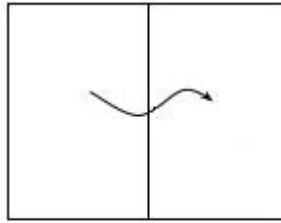

Ans

X 1.

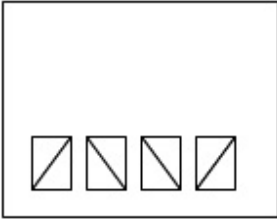

X 2.

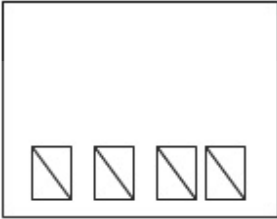

✓ 3.

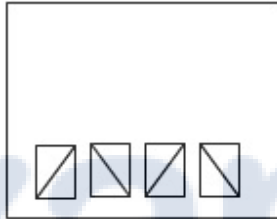

X 4.



Q.19 Which figure should replace the question mark (?) if the series were to be continued?

M	3	E	A	L	S	I	M	
E	I	M	3	I	E	L	S	?
A	V	I	L	M	3	E	6	

Ans

✗ 1.

6	2
E	S
L	I

✗ 2.

S	2
E	6
L	I

✗ 3.

6	M
E	I
L	S

✓ 4.

6	2
E	I
L	S

Q.20 Select a figure from amongst the four given options which, when placed in the blank space of figure (X), would complete the pattern.

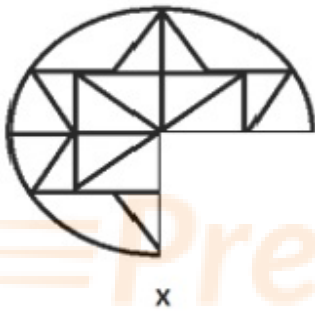

Ans

✗ 1.

✓ 2.

✗ 3.

✗ 4.

Q.21 Muskan, Amrita, Pranjali, Deepti, Riya and Sonali are six friends sitting around a circle facing the centre. Muskan Amrita and Pranjali. Amrita is opposite to Deepti. Riya is not the immediate neighbour of Amrita. Who is opposite

- Ans
- 1. Pranjali
 - 2. Deepti
 - 3. Riya
 - 4. Muskan

Q.22 Select the option that represents the letters that, when sequentially placed from left to right in the blanks below, will complete the letter series.

A Q _ _ S A _ W E _ A _ _ E S _ Q W _ S

- Ans
- 1. WSQSQAWE
 - 2. WESQWAVE
 - 3. WEQSQAWE
 - 4. WEQSQWAE

Q.23 Select a figure from amongst the four given options which, when placed in the blank space of figure (X), would complete the pattern.

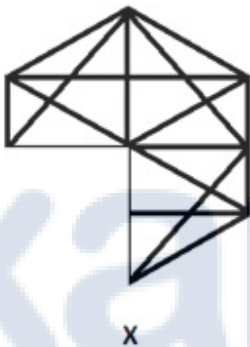

Ans

- 1.
- 2.
- 3.
- 4.

Q.24 Two statements are given followed by two conclusions numbered I and II. Assuming the statements to be true, even if they seem to be at variance with commonly known facts, decide which of the conclusions logically follow(s) from the statements.

Statements:

All insects are birds.
Some birds are fishes.

Conclusions:

I. All fishes are insects.
II. Some fishes are insects.

- Ans
- 1. Neither conclusion I nor II follows
 - 2. Only conclusion II follows
 - 3. Only conclusion I follows
 - 4. Both conclusions I and II follow

Q.25 A square sheet of paper is folded along the dotted line successively along the directions shown and is then punched last. How would the paper look when unfolded?

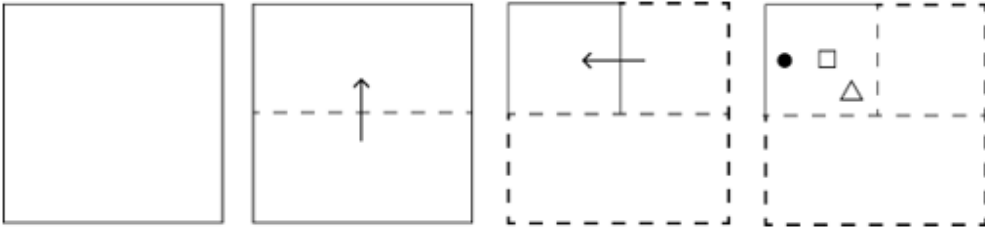

Ans

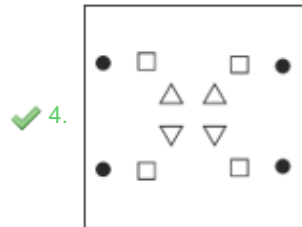
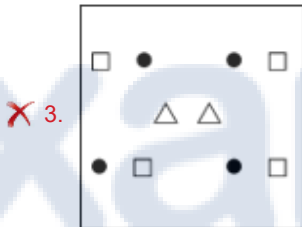
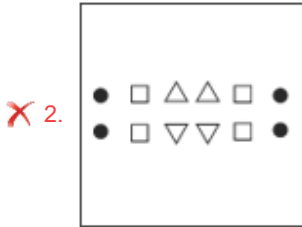
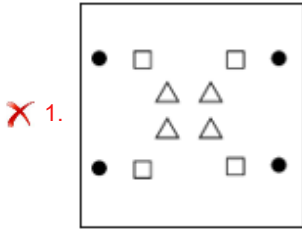

Section : Numerical Ability

Q.1 Find the time taken by a train 750 m long to cross a platform twice its length at a speed of 81 km/h.

- Ans
- ✗ 1. 80 sec
 - ✗ 2. 90 sec
 - ✓ 3. 100 sec
 - ✗ 4. 75 sec

Q.2 The marked price of a book is ₹767. A shopkeeper allows a discount of 20% and still earns a profit of 30%. Find the cost price of the book (in ₹).

- Ans
- ✗ 1. 525
 - ✗ 2. 450
 - ✗ 3. 680
 - ✓ 4. 472

Q.3 Simplify the following.
(8888 ÷ 88) ÷ 5

- Ans
- 1. $25\frac{1}{4}$
 - 2. $20\frac{1}{5}$
 - 3. $22\frac{1}{5}$
 - 4. $15\frac{1}{5}$

Q.4 P aims to get total 360 marks out of 500. He gets 5% less than his target. How much does he get?

- Ans
- 1. 330
 - 2. 325
 - 3. 340
 - 4. 335

Q.5 Deepak sold a bike to Sharath at a profit of 40%. Sharath sold his bike to Sivaji at a loss of 30%. If Deepak paid ₹8,000 for this bike, then find the cost price of the bike for Sivaji.

- Ans
- 1. ₹7,840
 - 2. ₹5,423
 - 3. ₹11,200
 - 4. ₹6,728

Q.6 A man borrows ₹2,196 and agrees to return it with compound interest at the rate of 25% in three equal annual instalments at the end of the first, second and the third year. The amount of instalment (in ₹) is:

- Ans
- 1. 984
 - 2. 1,125
 - 3. 1,072
 - 4. 732

Q.7 If $A : B : C = 2 : 3 : 5$, then the ratio $\frac{A}{B} : \frac{B}{C} : \frac{C}{A}$ is equal to:

- Ans
- 1. 20 : 25 : 39
 - 2. 20 : 18 : 75
 - 3. 18 : 20 : 79
 - 4. 75 : 20 : 29

Q.8 Find the HCF of 3.6, 0.54 and 1.08.

- Ans
- 1. 1.8
 - 2. 18
 - 3. 0.018
 - 4. 0.18

Q.9 The concentration of three wines A, B, and C is given as 15%, 30%, and 45%, respectively. They are mixed in the ratio of p : 5 : 3, resulting in a 30% concentration solution. What is the value of p?

- Ans
- 1. 2
 - 2. 1
 - 3. 3

1. 4

Q.10 A sum was invested at a certain rate of simple interest per annum for 2 years. Had it been invested at 3% per annum rate than the existing rate, the simple interest accrued in the 2 years would have been ₹240 more. The sum invested

- Ans**
- 1. ₹16,000
 - 2. ₹4,000
 - 3. ₹24,000
 - 4. ₹6,000

Q.11 Evaluate $\frac{(4.7)^2 - (1.3)^2}{4.7 - 1.3}$.

- Ans**
- 1. 3
 - 2. 5
 - 3. 4
 - 4. 6

Q.12 There are 4 horses grazing at each corner of a square field of side 63 m. They are roped in such a way that they can touch the middle of each side. Find the remaining area of the ground where they do not graze. (Use $\pi = \frac{22}{7}$)

- Ans**
- 1. 850.50 m²
 - 2. 780.50 m²
 - 3. 750.50 m²
 - 4. 800.50 m²

Q.13 A number y, when reduced by 25%, becomes 120% of a second number z. What percentage of z is y?

- Ans**
- 1. 160%
 - 2. 150%
 - 3. 175%
 - 4. 145%

Q.14 If A and B together can complete a work in 15 days, B and C together in 12 days and C and A together in 10 days, then in how many days can B alone complete the work?

- Ans**
- 1. 30
 - 2. 40
 - 3. 35
 - 4. 45

Q.15 The radius of a sphere is 1.8 cm. Find the exact volume (in cm³) of this sphere.

- Ans**
- 1. 7.776 π
 - 2. 7.676 π
 - 3. 7.786 π
 - 4. 7.766 π

Section : Computer Proficiency

Q.1 Which of the following is a shortcut key for Save as option in MS Word 365?

- Ans**
- 1. F12
 - 2. F2
 - 3. F11
 - 4. F1

Q.2 In MS Excel 365 which of the following statements related to deleting rows in an excel sheet is correct?

- Ans**
- 1. If you want to delete multiple rows at once, simply select the rows by clicking and dragging over the row numbers, press 'Ctrl' and '+'.
 2. If you want to delete multiple rows at once, simply select the rows by clicking and dragging over the row numbers, and then press 'Ctrl' and '-'.
 3. If you want to delete multiple rows at once, simply select the rows by clicking and dragging over the row numbers, and then press 'Ctrl' and 'Enter'.
 4. If you want to delete multiple rows at once, simply select the rows by clicking and dragging over the row numbers, and then press 'Ctrl' and 'space'.

Q.3 Which of the following shortcut keys is used to copy formatting in MS Word 365?

- Ans**
- 1. Ctrl + Shift + D
 - 2. Ctrl + Shift + V
 - 3. Ctrl + Shift + C
 - 4. Ctrl + Shift + A

Q.4 Which menu tab on Microsoft Word's 365 ribbon contains options for text formatting and editing?

- Ans**
- 1. View
 - 2. Insert
 - 3. Home
 - 4. File

Q.5 What is the purpose of the 'Font Color' option in Microsoft Word 365?

- Ans**
- 1. Changing the colour of the text
 - 2. Changing the font size
 - 3. Applying a background colour to text
 - 4. Changing the font style

Q.6 What information is typically required to sign in to an email client?

- Ans**
- 1. Full name and date of birth
 - 2. Social media account details
 - 3. Phone number and address
 - 4. Email address and password

Q.7 Which of the following services allows users to buy and sell products online?

- Ans**
- 1. Video conferencing
 - 2. Instant messaging
 - 3. Streaming
 - 4. E-commerce

Q.8 In MS Excel 365, which of the following is the correct sequence for deleting a column in MS-Excel spreadsheet?

- Ans**
- 1. Select the cell<<Left click<<Delete<<Entire Column
 - 2. Select the cell<<Right click<<Delete<<Entire Column
 - 3. Select the cell<<Left click<<Delete<<Entire Row
 - 4. Select the cell<<Right click<<Delete<<Entire Row

Q.9 Which of the following is a common element in an MS Word 365 document's header or footer?

- Ans**
- 1. Font colour
 - 2. Page number
 - 3. Document title
 - 4. Bullet points

Q.10 In MS Excel 365, which of the following is NOT a method to open a spreadsheet in MS-Excel?

- Ans
- 1. Ctrl + N
 - 2. Shift + Ctrl + N
 - 3. Alt + F + O
 - 4. File -> open



Prepare 50% Faster

Constable Executive Male and Female in Delhi Police Examination 2023

Exam Date	16/11/2023
Exam Time	3:00 PM - 4:30 PM
Subject	Constable Executive Male and Female in Delhi Police Examination 2023

Section : General Knowledge

Q.1 Which Indian dance form has the Mahari dance style?

- Ans**
- 1. Kathak
 - 2. Mohiniyattam
 - 3. Kathakali
 - 4. Odissi

Q.2 Which concept is related to the disposal of the equity of public sector units in the market for covering the fiscal deficit of the central government?

- Ans**
- 1. Denationalisation
 - 2. Disinvestment
 - 3. Liberalisation
 - 4. Globalisation

Q.3 As per Human Development Report 2021-22, what is the female Life Expectancy at birth in India?

- Ans**
- 1. 73.9 years
 - 2. 63.9 years
 - 3. 65.9 years
 - 4. 68.9 years

Q.4 Identify the artist who is NOT related to the Carnatic music family.

- Ans**
- 1. Begum Akhtar
 - 2. Aruna Sairam
 - 3. MS Subbulakshmi
 - 4. TS Vinayakram

Q.5 The number of white rooks used in chess is _____.

- Ans**
- 1. one
 - 2. four
 - 3. three
 - 4. two

Q.6 In which year was Volleyball Federation of India established?

- Ans**
- 1. 1949
 - 2. 1948
 - 3. 1951
 - 4. 1950

Q.7 Who among the following was re-elected in 1938 as the president of the Indian National Congress session for 1938?

- Ans**
- 1. Satyendra Prasanna Sinha
 - 2. Subhash Chandra Bose
 - 3. Pattabhi Sittaramayya
 - 4. Lal Mohan Ghosh

Q.8 Which Article of the Indian Constitution is related with promotion of co-operative societies?

- Ans**
- 1. Article 31 B
 - 2. Article 39 A
 - 3. Article 43 B
 - 4. Article 51 A

Q.9 From which of the following states/union territories does the Yamuna River originate?

- Ans**
- 1. Himachal Pradesh
 - 2. Uttar Pradesh
 - 3. Jammu and Kashmir
 - 4. Uttarakhand

Q.10 Identify the southernmost major port of India.

- Ans**
- 1. Kochi
 - 2. Mangaluru
 - 3. Chennai
 - 4. Tuticorin

Q.11 'Imperfect' is the autobiography of which Indian cricketer?

- Ans**
- 1. Sanjay Manjrekar
 - 2. Kapil Dev
 - 3. Sunil Gavaskar
 - 4. Ravi Shastri

Q.12 Dr. Atmaram Pandurang and Justice Ranade founded the _____ in Maharashtra espousing principles of enlightenment based on Vedas.

- Ans**
- 1. Bharat Dharma Mahamandal
 - 2. Brahma Samaj
 - 3. Prarthana Samaj
 - 4. Arya Samaj

Q.13 Which of the following is NOT found in animal cells?

- Ans**
- 1. Plastid
 - 2. Mitochondria
 - 3. Golgi Complex
 - 4. Endoplasmic reticulum

Q.14 _____ has a curving shape, a feature found in Nagara architecture.

- Ans**
- 1. Mandapa
 - 2. Antarala
 - 3. Shikhara
 - 4. Kutina

Q.15 In which state of India was the first train introduced in the year 1853?

- Ans
- 1. Rajasthan
 - 2. West Bengal
 - 3. Maharashtra
 - 4. Karnataka

Q.16 Which produce was available as a surplus marketed by the farmers in the market during the Green Revolution?

- Ans
- 1. Wheat and rice
 - 2. Rice and maize
 - 3. Wheat and jowar
 - 4. Oil seeds

Q.17 Which of the following methods can be used for liberalisation?

- Ans
- 1. Abolishing licensing requirement in most industries
 - 2. Restrictions in fixing the prices of goods and services
 - 3. Making procedures for imports and exports tough
 - 4. Increase in taxes

Q.18 When the lava makes its way through cracks and the fissures developed in the land, it solidifies almost perpendicular to the ground. It gets cooled in the same position to develop a wall-like structure. What is the structure called?

- Ans
- 1. Lacolith
 - 2. Dykes
 - 3. Lapolith
 - 4. Phacolith

Q.19 Which portal was launched by SIDBI to improve accessibility of credit and handholding services to MSMEs?

- Ans
- 1. Sampark
 - 2. Udyami Mitra
 - 3. MSME Champions
 - 4. Samadhan

Q.20 Which Article allows the Council of Ministers to aid and advise the President?

- Ans
- 1. Article 52
 - 2. Article 70
 - 3. Article 61
 - 4. Article 74

Q.21 Which canal has a head regulator capacity of 1133 cumecs (40000 cusecs) and a length of 532 km for which it is considered the world's largest lined irrigation canal?

- Ans
- 1. Cumbarjua Canal
 - 2. Kalingarayan Canal
 - 3. Narmada Main Canal
 - 4. Trivandrum-Shoranur canal

Q.22 Which of the given statements about Vitamin A are correct?

Statement A: Beta-carotene is a precursor to Vitamin A.

Statement B: Leafy green vegetables and yellow fruits are good sources of Vitamin A.

- Ans
- 1. Only Statement B
 - 2. Only Statement A
 - 3. Neither Statement A nor B
 - 4. Both Statements A and B

Q.23 The Indian government launched the 'Garib Kalyan Rojgar Abhiyaan' ('GKRA') on 20th June 2020 to provide work many days?

- Ans**
- 1. 130 days
 - 2. 125 days
 - 3. 115 days
 - 4. 120 days

Q.24 Who described India as a 'Quasi-Federation'?

- Ans**
- 1. Harold Joseph Laski
 - 2. Ivor Jennings
 - 3. KC Wheare
 - 4. KM Munshi

Q.25 The originator of Buddhism, Gautam Buddha, was the prince of which of the following republican states during the Mahajanapada period in Ancient India?

- Ans**
- 1. Vajji
 - 2. Kamboja
 - 3. Kuru
 - 4. Shakya

Q.26 Which political party was in power when Sardar Swaran Singh Committee made recommendations about Fundamental Duties?

- Ans**
- 1. Indian National Congress
 - 2. Communist Party of India
 - 3. Janata Dal
 - 4. Bharatiya Janata Party

Q.27 Which Viceroy of India took initiative in creating local government bodies in India?

- Ans**
- 1. Lord Harding II
 - 2. Lord Minto
 - 3. Lord Rippon
 - 4. Lord Mayo

Q.28 The Brahma Samaj, which promotes the principal of social equality, was founded by _____.

- Ans**
- 1. Swami Dayanand
 - 2. Debendranath Tagore
 - 3. Raja Ram Mohan Roy
 - 4. Swami Vivekananda

Q.29 Playing It My Way: My Autobiography, is the book written by whom among the following cricketers?

- Ans**
- 1. Virat Kohli
 - 2. Kapil Dev
 - 3. Sachin Tendulkar
 - 4. Rahul Dravid

Q.30 In 2016, Yamini Krishnamurthy received the Padma Vibhushan for her contribution to which fields of classical dance?

- Ans**
- 1. Bharatanatyam and Odissi
 - 2. Bharatanatyam and Kuchipudi
 - 3. Bharatanatyam and Kathak
 - 4. Bharatanatyam and Manipuri

Q.31 The Annapurna Scheme was launched by the Government of India in the year _____ for providing food security

- Ans
- 1. 2002
 - 2. 2000
 - 3. 2003
 - 4. 2001

Q.32 Which of the following countries won the highest number of Kabaddi World Cups, as of 2022?

- Ans
- 1. Pakistan
 - 2. Bangladesh
 - 3. India
 - 4. Iran

Q.33 In which year was the Malegam Committee appointed to study issues and concerns of the Micro Finance Sector?

- Ans
- 1. 2005
 - 2. 2010
 - 3. 2015
 - 4. 2018

Q.34 Which of the following were the two major internal land routes through which trade and commerce took place in the post-Mauryan period?

- Ans
- 1. Pashchimpatha and Uttarapatha
 - 2. Dakshinapatha and Purvapatha
 - 3. Dakshinapatha and Pashchimpatha
 - 4. Uttarapatha and Dakshinapatha

Q.35 Which of the following statements is NOT true about the two-sector model?

- Ans
- 1. The government sector plays an important role.
 - 2. Firms are the only producing sector in the economy.
 - 3. There is no foreign sector
 - 4. The economy is considered to be closed.

Q.36 Which species plays a keystone role in supporting insectivore populations with a year-round available food resource?

- Ans
- 1. Meliaceae species
 - 2. Ficus species
 - 3. Cycas species
 - 4. Ziziphus species

Q.37 In which pair of states is Holi also celebrated as Dola Purnima?

- Ans
- 1. Rajasthan and Punjab
 - 2. Maharashtra and Gujarat
 - 3. West Bengal and Odisha
 - 4. Nagaland and Sikkim

Q.38 Who issued the silver rupee, which remained a standard coin for centuries after the ruler?

- Ans
- 1. Humayun
 - 2. Babur
 - 3. Sher Shah Suri
 - 4. Akbar

Q.39 Seema switched on an electric circuit and went away to drink some water. She came back after 2 minutes and no the circuit had 2.5 A of current flowing through it. The net charge that had flown through the circuit is:

- Ans**
- 1. 0.0833 C
 - 2. 300 C
 - 3. 1.25 C
 - 4. 5 C

Q.40 Which of the following temples is built in the hoyasala architectural style?

- Ans**
- 1. Khajuraho Temple
 - 2. Konark temple
 - 3. Kesava Temple
 - 4. Ladkhan Temple

Q.41 Which of the following was opened by Gour Mohan Addy in 1829?

- Ans**
- 1. Oriental Seminary
 - 2. Anglo-India Seminary
 - 3. Hindi Seminary
 - 4. Anglo-Indian School

Q.42 Which of the following Articles deals with the amendment of the Indian Constitution?

- Ans**
- 1. Article 352
 - 2. Article 356
 - 3. Article 360
 - 4. Article 368

Q.43 Ustad Latafat Hussain Khan is associated with the _____.

- Ans**
- 1. Agra gharana
 - 2. Kirana gharana
 - 3. Patiala gharana
 - 4. Gwalior gharana

Q.44 In which of the following years was the first edition of the Indian Super League (ISL) held?

- Ans**
- 1. 2013
 - 2. 2015
 - 3. 2014
 - 4. 2016

Q.45 Tariffs and quotas in the trade issues are used to _____.

- Ans**
- 1. promote free trade between countries
 - 2. protect only the private sector
 - 3. protect only the public sector
 - 4. protect domestic companies

Q.46 The Hunta dance of Jharkhand is associated with which tribal community?

- Ans**
- 1. Munda
 - 2. Santhal
 - 3. Kol
 - 4. Oraon

Q.47 Sunayana Hazarilal won the Padma Shri for which form of classical dance?

- Ans**
- 1. Kathakali
 - 2. Odissi
 - 3. Bharatanatyam
 - 4. Kathak

Q.48 When is the festival of Ram Navami celebrated in India?

- Ans**
- 1. Ninth day of Chaitra month
 - 2. Ninth day of Ashwin month
 - 3. Ninth day of Magha month
 - 4. Ninth day of Pausha month

Q.49 Who was the author of the famous work 'Shishupala Vadha'?

- Ans**
- 1. Magha
 - 2. Bhatti
 - 3. Jayadeva
 - 4. Bharavi

Q.50 Article 51 of Directive Principles of State Policy enumerates which of the following?

- Ans**
- 1. Promotion of international peace and security
 - 2. Separation of judiciary from executive
 - 3. Uniform civil code for the citizens
 - 4. Organisation of agricultural and animal husbandry

Section : Reasoning

Prepare 50% Faster

Q.1 A square sheet of paper is folded along the dotted line successively along the directions shown and is then punched last. How would the paper look when unfolded?

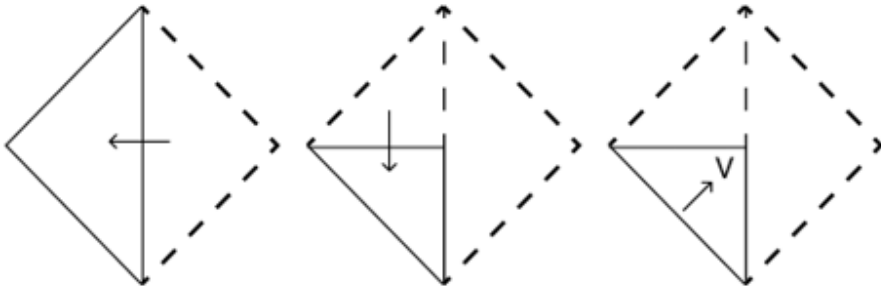

Ans

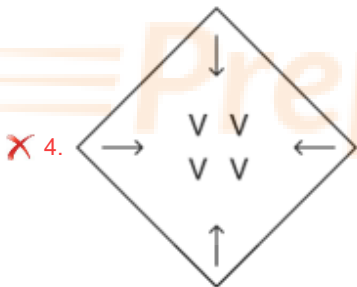
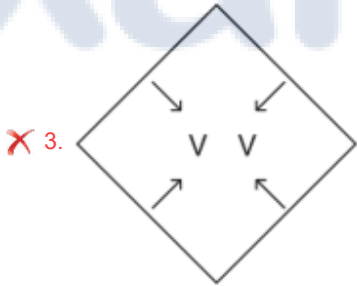
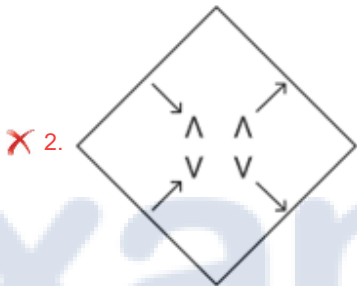
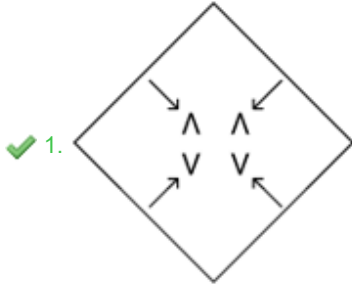

Q.2 Six numbers, 1, 2, 3, 4, 5 and 6, are written on the different faces of a dice. Three different positions of the same dice are shown (Figures 1-3). Find the number on the face opposite to the face showing '4'.

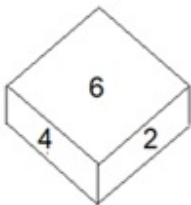

Figure 1

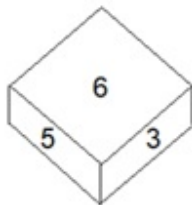

Figure 2

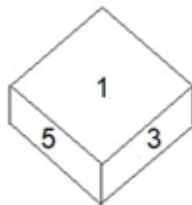
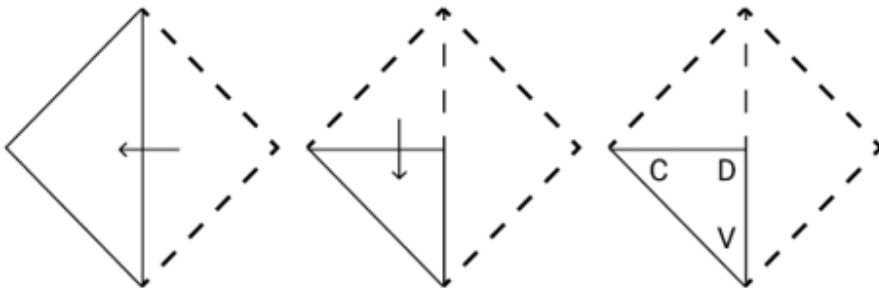

Figure 3

Ans ✗ 1. 3

✓ 2. 5

Q.3 A square sheet of paper is folded along the dotted line successively along the directions shown and is then punched last. How would the paper look when unfolded?



Ans

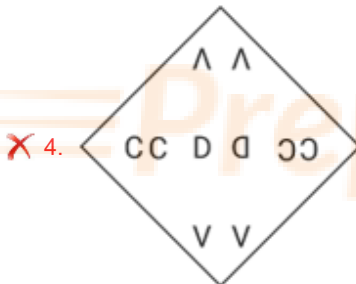
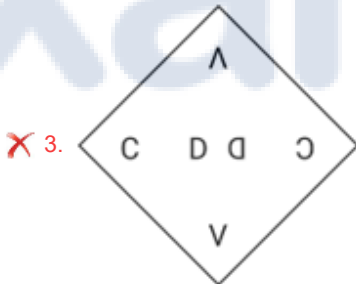
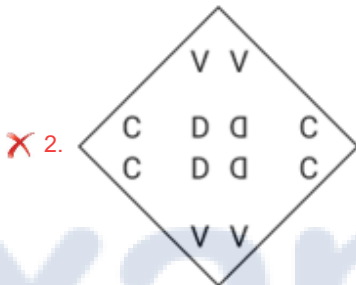
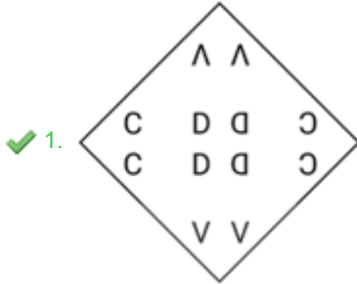

Q.4 Select the option in which the given figure is embedded (rotation is NOT allowed).

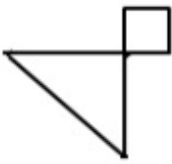

Ans

1.

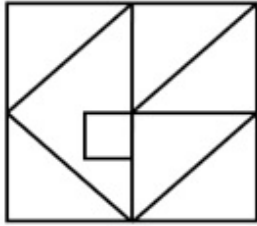

2.

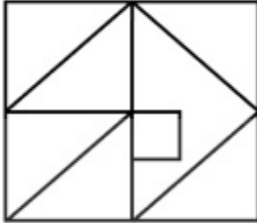

3.

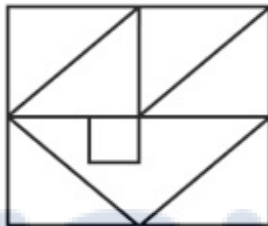

4.

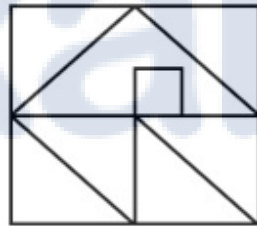

Q.5 H, I, J, K and L are five people sitting in a straight line facing North. I sits exactly between J and K. K sits to the immediate left of H. L sits at the extreme right end. Who sits at the extreme left end?

Ans 1. H

2. K

3. I

4. J

Q.6 Which of the following letter clusters will replace the question mark (?) in the given series to make it logically complete?
DSB, GVY, JYV, MBS, ?

Ans 1. PEP

2. PDP

3. PEQ

4. PEO

Q.7 Choose the dice from the given options that is similar to the dice formed from the given sheet of paper (X).

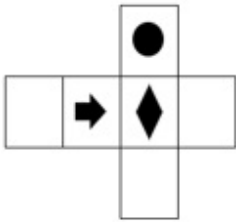

(X)

Ans

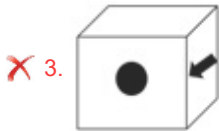
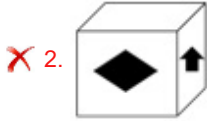
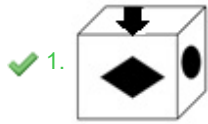

Q.8 Which figure should replace the question mark (?) if the series were to be continued?

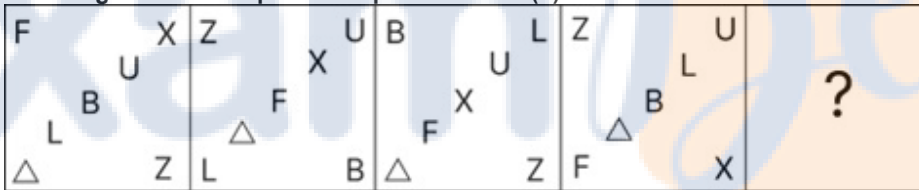

Ans

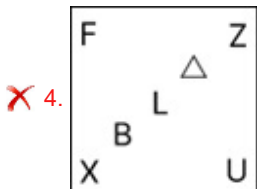
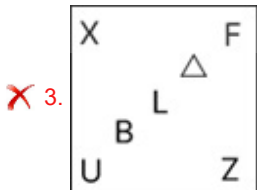
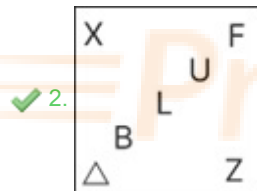
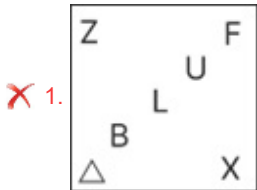

Q.9 Select the option that is related to the fifth letter-cluster in the same way as the second letter-cluster is related to letter-cluster and the fourth letter-cluster is related to the third letter-cluster.
LINK : NKPM :: PART : RCTV :: PATH : ?

- Ans
- 1. NCVK
 - 2. RCWJ
 - 3. RCVJ
 - 4. RBVK

Q.10 Select the set in which the numbers are related in the same way as are the numbers of the following sets.

(NOTE : Operations should be performed on the whole numbers, without breaking down the numbers into its constituent digits. E.g. 13 – Operations on 13 such as adding /deleting /multiplying etc. to 13 can be performed. Breaking down 13 into 1 and 3 and then performing mathematical operations on 1 and 3 is not allowed.)
(33, 11, 66)
(45, 15, 90)

- Ans
- 1. (51, 17, 104)
 - 2. (51, 17, 102)
 - 3. (51, 19, 102)
 - 4. (53, 19, 102)

Q.11 Six numbers, 1, 2, 3, 4, 5 and 6 are written on different faces of a dice. Three positions of this dice are shown in here. Find the number on the face opposite 6.

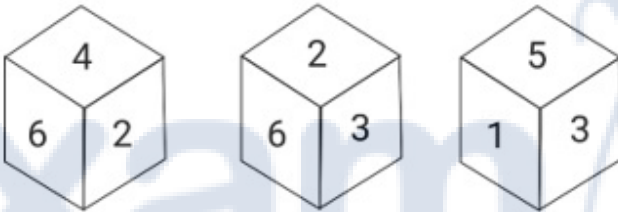

- Ans
- 1. 1
 - 2. 5
 - 3. 3
 - 4. 4

Q.12 Select the correct combination of mathematical signs that can sequentially replace the * signs and balance the given expression.

$$96 * 12 * 15 * 7 * 36 * 77$$

- Ans
- 1. -, ÷, +, ×, =
 - 2. +, ×, -, ÷, =
 - 3. -, ×, +, ÷, =
 - 4. ÷, +, ×, -, =

Q.13 Six numbers, 1, 2, 3, 4, 5 and 6, are written on the different faces of a dice. Two positions of this dice are shown in the given figure. Find the number on the face opposite to 5.

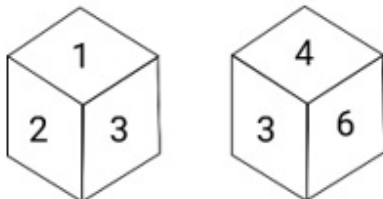

- Ans
- 1. 3
 - 2. 6
 - 3. 2
 - 4. 1

Q.14 In a certain code language, 'live long' is coded as 'east west', 'long pole' is coded as 'east south', 'star wars' is coded as 'ward four', and 'pole star' is coded as 'south ward'. What is the code for the word 'wars'?

- Ans
- 1. ward
 - 2. four
 - 3. pole
 - 4. long

Q.15 A cube (dice) has six different numbers drawn over its six faces. Three different positions of this cube are shown in the given figure. Which number is on the face opposite to '1'?

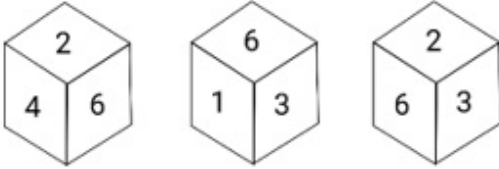

- Ans
- 1. 3
 - 2. 6
 - 3. 4
 - 4. 2

Q.16 Select the number from the given options that can replace the question mark (?) in the following series. 24, 21, 16, 13, 8, ?

- Ans
- 1. 5
 - 2. 2
 - 3. 7
 - 4. 3

Q.17 Select the correct mirror image of the given figure when the mirror is placed at PQ as shown below.



- Ans
- 1. # ! @ # W \$ ^ & * + _
 - 2. # ! @ # W \$ ^ & + * _
 - 3. # ! @ # W ^ \$ & * + _
 - 4. # ! @ # M \$ ^ & * + _

Q.18 Select the option figure which is embedded in the given figure as its part (rotation is NOT allowed).

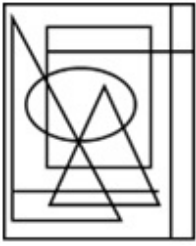

Ans

1.



2.



3.



4.



Q.19 Select the correct combination of mathematical signs that can sequentially replace the * signs and balance the given expression.

$$72 * 5 * 7 * 64 * 8 * 45$$

Ans

1. +, ×, −, ÷, =

2. −, ×, +, ÷, =

3. ÷, +, ×, −, =

4. −, ÷, +, ×, =

Prepare 50% Faster

Q.20 Select the option figure that will replace the question mark (?) in the figure given below to complete the pattern.

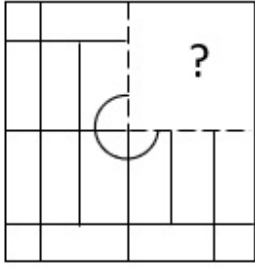

Ans

✗ 1.

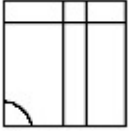

✓ 2.

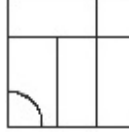

✗ 3.

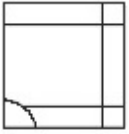

✗ 4.



ixamBee

Prepare 50% Faster

Q.21 Which figure should replace the question mark (?) in the following series to continue the pattern?

△	3	3	S	B	△	△	U	
	B	U	U	H	S	9	9	3
S		H	△	B	U	3	B	S
								?

Ans

✗ 1.

R	B
U	S
9	3

✓ 2.

S	B
U	R
9	△

✗ 3.

S	B
△	R
U	9

✗ 4.

9	B
S	R
U	△

Q.22 Two statements are given followed by two conclusions numbered I and II. Assuming the statements to be true, even if they seem to be at variance from commonly known facts, decide which of the conclusions logically follow(s) from the statements.

Statements:
Some Witches are Humans.
All Humans are Cold.

Conclusions:
I. All Witches are Cold.
II. Some Witches are Cold.

Ans

✗ 1. Both conclusions I and II follow.

✗ 2. Neither conclusion I nor II follows.

✓ 3. Only conclusion II follows.

✗ 4. Only conclusion I follows.

Q.23 How many triangles are there in the given figure?

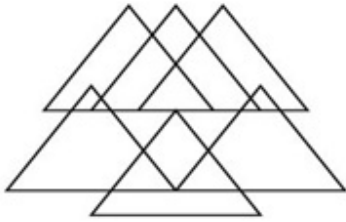

- Ans
- 1. 12
 - 2. 19
 - 3. 10
 - 4. 15

Q.24 Given below is a series of figures – A, B, C and D which follow a particular pattern. Which of the given option figures should come in place of E to continue the series?



(A) (B) (C) (D) (E)

- Ans
- 1.
 - 2.
 - 3.
 - 4.

Q.25 Select the option that is related to the fourth number in the same way as the first number is related to the second number and the fifth number is related to the sixth number.
7586 : 8943 :: ? : 6749 :: 8405 : 9762

- Ans
- 1. 6321
 - 2. 5392
 - 3. 5412
 - 4. 5586

Section : Numerical Ability

Q.1 Let $x = \frac{6}{7}$ and let $y = \frac{1}{x}$. y is _____ more than x .

- Ans
- 1. 33.66%
 - 2. 33.33%
 - 3. 36.66%
 - 4. 36.11%

Q.2 What is the number between 2800 and 3000, which when divided by 24, 32 and 45, leaves no remainder?

- Ans
- 1. 2960
 - 2. 2840
 - 3. 2880
 - 4. 2920

Q.3 P invested a certain amount in shares. The shares rose successively by 20% and 30% on two consecutive days and fell by 25% and 11% in the next two days. What is the percentage increase or decrease in the value of the shares in four days?

- Ans
- 1. Increase of 4.13%
 - 2. Decrease of 4.13%
 - 3. Increase of 3.62%
 - 4. Decrease of 3.62%

Q.4 If $a : b = 5 : 3$, then $(a^3 - b^3) : (a^3 + b^3) = ?$

- Ans
- 1. 25 : 76
 - 2. 49 : 16
 - 3. 11 : 25
 - 4. 49 : 76

Q.5 A train covers a distance of 54 km from station A to station G in an hour via stations B, C, D, E and F. On each station, the train stops for 72 seconds. What is the speed of the train in km/h?

- Ans
- 1. 62
 - 2. 58
 - 3. 64
 - 4. 60

Q.6 The difference between the compound interest and the simple interest on ₹80,000 at the same rate of interest per annum for 2 years is ₹98. What is the rate of interest per annum?

- Ans
- 1. $3\frac{1}{2}\%$
 - 2. $5\frac{1}{2}\%$
 - 3. $2\frac{1}{2}\%$
 - 4. $7\frac{1}{2}\%$

Q.7 If Anand can do a piece of work in 9 days and Vinod can complete the same work in 6 days, then in how many days will both of them complete it together?

- Ans
- 1. $\frac{1}{6}$ days
 - 2. $\frac{1}{96}$ days
 - 3. $\frac{96}{5}$ days
 - 4. $\frac{18}{5}$ days

Q.8 If the average of 6, 7, 12, (x - 1) and 10 is 10, then the value of x is:

- Ans
- 1. 12
 - 2. 15
 - 3. 14
 - 4. 16

Q.9 Simplify the following.

$$\sqrt{\frac{0.009 \times 0.025 \times 0.016 \times 0.08}{0.002 \times 0.0008 \times 0.0002}}$$

- Ans
- 1. 30
 - 2. 18
 - 3. 16
 - 4. 72

Q.10 A machine is sold for ₹4,800 at a gain of 20%. What would have been the gain or loss percentage if it had been sold for ₹4,500?

- Ans
- 1. 12.5% gain
 - 2. 12.5% loss
 - 3. 25% loss
 - 4. 25% gain

Q.11 A dishonest financier claims to be lending money at simple interest, but he includes the interest every four months for calculating the principal. If he is charging an interest of 3%, the effective rate of interest becomes:

- Ans
- 1. 2.06%
 - 2. 3.03%
 - 3. 3.01%
 - 4. 2.01%

Q.12 If the circumference of the great circle of a hemisphere is 9π cm, then find the total surface area of the hemisphere?

- Ans
- 1. 54.85π cm²
 - 2. 50.65π cm²
 - 3. 60.75π cm²
 - 4. 62.35π cm²

Q.13 The marked price of an item is $\frac{9}{8}$ of the cost price. How much percentage discount should be offered to get a profit of 3%?

- Ans
- 1. 5.44%
 - 2. 6.44%
 - 3. 8.44%
 - 4. 7.44%

Q.14 Let a and b be two numbers such that a and b - a are co-primes and b and b + a are co-primes, respectively. Which of the followings is true?

- Ans
- 1. b is prime
 - 2. a and b are co-prime
 - 3. a is prime
 - 4. a and b are not co-prime

Q.15 Vishy needs to paint the surfaces of three different spherical balls, having radii of 30 cm, 40 cm, and 50 cm, respectively. The cost of paint needed to paint π cm² is given as ₹0.60, what will be the total cost (in ₹) of the quantity of paint needed to paint the surfaces of all the three balls mentioned above?

- Ans**
- 1. 11700
 - 2. 12000
 - 3. 11400
 - 4. 12600

Section : Computer Proficiency

Q.1 In MS Excel 365, which alignment option in Microsoft Excel is used to align the text to both the left and right sides of the cell, creating a neat and justified appearance?

- Ans**
- 1. Justify
 - 2. Right Align
 - 3. Centre Align
 - 4. Left Align

Q.2 Which of the following fields tells the recipient what the message is about?

- Ans**
- 1. To
 - 2. Signature
 - 3. Subject
 - 4. Date

Q.3 The term 'ISP' stands for _____, in the context of internet architecture.

- Ans**
- 1. Internet Service Protocol
 - 2. Internet Service Provider
 - 3. International Service Provider
 - 4. Intranet Service Provider

Q.4 Which of the following options can be used when we need to retype the same text as it reduces time and effort in MS Word 365?

- Ans**
- 1. Cut
 - 2. Find
 - 3. Replace
 - 4. Copy

Q.5 In MS Excel 365 what does the 'Save As' option allow you to do that the regular 'Save' option does not?

- Ans**
- 1. Save the workbook without any changes
 - 2. Save the workbook with the same name
 - 3. Save the workbook without confirmation
 - 4. Save the workbook with a new name or location

Q.6 Which of the following is NOT a text alignment in MS-Word 365?

- Ans**
- 1. Align Text Justify
 - 2. Align Text Right
 - 3. Align Text Middle
 - 4. Align Text Center

Q.7 In MS word 365, What does the 'Number of Copies' option in the Print Settings dialog allow you to do?

- Ans
- 1. Adjust the font size
 - 2. Specify the number of pages to print
 - 3. Specify how many copies of the document to print
 - 4. Choose the paper size

Q.8 Which of the following is the correct combination of a column letter and a row number that identifies a cell on a worksheet in MS Excel?

- Ans
- 1. A3
 - 2. 33
 - 3. 3A
 - 4. AA

Q.9 In MS word 365, what is the keyboard shortcut to copy selected text in most applications?

- Ans
- 1. Ctrl + X
 - 2. Ctrl + C
 - 3. Ctrl + Z
 - 4. Ctrl + V

Q.10 In the Page Setup group, which of the following is used to force the text after the break to start on a new page or document in MS word 365?

- Ans
- 1. Orientation
 - 2. Page Margins
 - 3. Page Size
 - 4. Page Break

Constable Executive Male and Female in Delhi Police Examination 2023

Exam Date	17/11/2023
Exam Time	9:00 AM - 10:30 AM
Subject	Constable Executive Male and Female in Delhi Police Examination 2023

Section : General Knowledge

Q.1 Which of the following string instruments is played by Braj Bhushan Kabra?

- Ans**
- 1. Mohan Veena
 - 2. Sitar
 - 3. Violin
 - 4. Guitar

Q.2 According to Census of India 2011, which of the following states recorded a population density of less than 100 persons/sq. km?

- Ans**
- 1. Assam
 - 2. Rajasthan
 - 3. Odisha
 - 4. Sikkim

Q.3 Who among the following has written the novel 'Pinjar'?

- Ans**
- 1. Mohan Rakesh
 - 2. Mannu Bhandari
 - 3. Amrita Pritam
 - 4. Bhisham Sahani

Q.4 A reaction wherein atoms of an element in the reactants are exchanged or replaced to form new elements in the product is called:

- Ans**
- 1. combustion
 - 2. addition reaction
 - 3. substitution reaction
 - 4. oxidation

Q.5 The _____ was abruptly called off by Mahatma Gandhi due to the Chauri Chaura incident.

- Ans**
- 1. Champaran Satyagraha
 - 2. Non-cooperation Movement
 - 3. Kheda Movement
 - 4. Rowlatt Act Satyagraha

Q.6 Torrential rain is any amount of rain that is considered especially heavy. Accordingly, which of the following Indian regions receives this type of rainfall during October and November?

- Ans**
- 1. Southeast Karnataka
 - 2. Central Maharashtra
 - 3. Western Rajasthan
 - 4. North Bengal

Q.7 Which ministry is implementing the 'PM DAKSH' scheme?

- Ans
- 1. Ministry of Education
 - 2. Ministry of Finance
 - 3. Ministry of Social Justice and Empowerment
 - 4. Ministry of Micro, Small and Medium Enterprises

Q.8 Olympian boxer Vijender Singh belongs to which of the following states?

- Ans
- 1. Haryana
 - 2. Chandigarh
 - 3. Delhi
 - 4. Punjab

Q.9 According to the census of India 2011, which of the following religions has the least population?

- Ans
- 1. Buddhists
 - 2. Sikhs
 - 3. Jains
 - 4. Christians

Q.10 Theyyam dance, performed to appease and make peace with the Gods who ensure good harvest and prosperity, is popular in which of the following states?

- Ans
- 1. Karnataka
 - 2. Kerala
 - 3. Andhra Pradesh
 - 4. Jharkhand

Q.11 Maintenance functions of a living organism is a _____ process.

- Ans
- 1. continuous
 - 2. short time
 - 3. one time
 - 4. long time

Q.12 Who among the following is known as the 'Shehnai maestro'?

- Ans
- 1. Hariprasad Chaurasia
 - 2. Ustad Bismillah Khan
 - 3. Ustad Bade Ghulam Ali Khan
 - 4. Ustad Amjad Ali Khan

Q.13 Who among the following was the leader of 1857 revolt in Ramgarh state?

- Ans
- 1. Uda Devi
 - 2. Zinat Mahal
 - 3. Avantibai Lodhi
 - 4. Jhalkaribai

Q.14 The Green Revolution was commenced under the leadership of whom among the following Prime Ministers of India?

- Ans
- 1. Charan Singh
 - 2. Morarji Desai
 - 3. Gulzarilal Nanda
 - 4. Lal Bahadur Shastri

Q.15 Which committee was appointed by the Government of India “to operationalise the suggestions to teach Fundamentals of Democracy to the citizens of India” ?

- Ans**
- 1. Justice Usha Mehra Committee
 - 2. Justice JS Verma Committee
 - 3. Justice BN Srikrishna Committee
 - 4. Justice AK Mathur Committee

Q.16 Who among the following Sultans of Delhi established Turkan-i-Chahalgani?

- Ans**
- 1. Iltutmish
 - 2. Alauddin Khilji
 - 3. Bhalal Lodhi
 - 4. Ghiyasuddin Balban

Q.17 Secunderabad is the headquarters of which railway zone?

- Ans**
- 1. Southern Railway Zone
 - 2. North Central Railway Zone
 - 3. South Central Railway Zone
 - 4. West Central Railway Zone

Q.18 Which of the following dates is correct with regard to the announcement of LPG model?

- Ans**
- 1. August 1991
 - 2. December 1991
 - 3. July 1991
 - 4. June 1991

Q.19 The Speaker and the Deputy Speaker of a state are elected by the _____.

- Ans**
- 1. Members of the Legislative Assembly
 - 2. Chief Justice of High Court
 - 3. Attorney General
 - 4. Chief Justice of Supreme Court

Q.20 The Rohtasgarh or Rohtas Fort is located in which river valley?

- Ans**
- 1. Son
 - 2. Ganga
 - 3. Karmanasa
 - 4. Ghaghara

Q.21 As of October 2022, in which of the following Harappan cities was the Citadel NOT walled off?

- Ans**
- 1. Lothal
 - 2. Mohenjo-Daro
 - 3. Harappa
 - 4. Kalibangan

Q.22 Who among the following personalities is an awardee of Sahitya Natak Akademi for his contribution to the Chhau dance?

- Ans**
- 1. Radha Reddy
 - 2. Reba Vidyarthi
 - 3. Chandralekha
 - 4. Chandra Shekhar Bhanj

Q.23 When is Kali Pooja celebrated in West Bengal region?

- Ans
- 1. Ashwin Poornima
 - 2. Kartika Amavasya
 - 3. Kartika Poornima
 - 4. Ashwin Amavasya

Q.24 'As I Lay Dying' is an English novel by which of the following authors?

- Ans
- 1. Aldous Huxley
 - 2. John Dos Passos
 - 3. Stella Gibbons
 - 4. William Faulkner

Q.25 Which Article of the Indian Constitution provides for an Independent Election Commission for the superintendence, direction and control of the electoral roll and the conduct of elections in India?

- Ans
- 1. Article 329
 - 2. Article 323
 - 3. Article 324
 - 4. Article 320

Q.26 Which species of Arthropods is horseshoe shaped, with hard shell and spine-like tail?

- Ans
- 1. Loligo
 - 2. Limulus
 - 3. Locusta
 - 4. Laccifer

Q.27 Who among the following was the author of Buddhacharita?

- Ans
- 1. Ashvaghosha
 - 2. Dandin
 - 3. Jinasena
 - 4. Shudraka

Q.28 During the Mauryan period, Kalinga was the ancient name of which dominant present-day coastal state?

- Ans
- 1. Karnataka
 - 2. Andhra Pradesh
 - 3. Tamil Nadu
 - 4. Odisha

Q.29 What type of architecture was constructed in Hampi temples and palaces?

- Ans
- 1. Dravidian
 - 2. Vesara
 - 3. Nagara
 - 4. Kalinga

Q.30 Which Indian dance form is Darshana Jhaveri the leading exponent of?

- Ans
- 1. Manipuri
 - 2. Kathak
 - 3. Odissi
 - 4. Kuchipudi

Q.31 At which of the following events did Punjab's Devansh Jagga break the national record in the Under-16 Discus Throw Competition?

- Ans
- 1. 35th AFI National Junior Athletics Championship
 - 2. 36th AFI National Junior Athletics Championship
 - 3. 37th AFI National Junior Athletics Championship
 - 4. 34th AFI National Junior Athletics Championship

Q.32 Under which of the following Writs can the Supreme Court and the High Courts call for the record of a case from a lower court or semi-judicial body on an allegation of an excess of jurisdiction?

- Ans
- 1. Quo Warranto
 - 2. Prohibition
 - 3. Mandamus
 - 4. Certiorari

Q.33 To remove unemployment through skill development, how much expenditure is permissible per person on training of the urban poor, under the Deen Dayal Antyodaya Yojana?

- Ans
- 1. ₹15,000
 - 2. ₹12,000
 - 3. ₹20,000
 - 4. ₹8,000

Q.34 The term 'scoop' is related to which of the following games?

- Ans
- 1. Football
 - 2. Badminton
 - 3. Boxing
 - 4. Hockey

Q.35 What is the range of temperature on the surface of the Moon with no atmosphere?

- Ans
- 1. -50°C to 120°C
 - 2. -80°C to 150°C
 - 3. -110°C to 190°C
 - 4. -190°C to 110°C

Q.36 What is the integration between countries through foreign trade and foreign investments by multinational corporations (MNCs)?

- Ans
- 1. Globalisation
 - 2. International trade
 - 3. International investment
 - 4. World trade

Q.37 The process of browning of sugar used extensively in cooking for the resulting sweet nutty flavour and brown colour is called:

- Ans
- 1. sterilisation
 - 2. caramelisation
 - 3. pasteurisation
 - 4. neutralisation

Q.38 जब कुल व्यय कुल प्राप्तियों से कम होता है, तो यह क्या कहलाता है?

- Ans
- 1. प्राक्कलन बजट
 - 2. बचत का बजट
 - 3. घाटे का बजट
 - 4. संतुलित बजट

Q.39 Yamini Krishnamurthy, an eminent _____ and Bharatanatyam dancer has been awarded the Padma Bhushan Padma Shri.

- Ans
- 1. Kathakali
 - 2. Kuchipudi
 - 3. Kathak
 - 4. Sattriya

Q.40 निम्नलिखित में से कौन-सी अवधारणा किसी देश के घरेलू क्षेत्र के भीतर मजदूरी, लाभ, किराया, ब्याज आदि के रूप में कारक लागत पर उत्पादन के कारकों द्वारा अर्जित आय को संदर्भित करती है?

- Ans
- 1. कारक लागत पर निवल घरेलू उत्पाद
 - 2. बाजार कीमतों पर निवल घरेलू उत्पाद
 - 3. बाजार कीमतों पर सकल घरेलू उत्पाद
 - 4. कारक लागत पर सकल राष्ट्रीय उत्पाद

Q.41 The term 'anchor runner' is related to _____.

- Ans
- 1. marathon race
 - 2. 1500 m race
 - 3. steeple chase
 - 4. relay race

Q.42 Who among the following headed the Constitutional States Committee formed for negotiating with the states?

- Ans
- 1. Jawaharlal Nehru
 - 2. Dr. Rajendra Prasad
 - 3. JB Kripalani
 - 4. Vallabhbhai Patel

Q.43 Small scale industries in 1950 were defined as all those industries in which the maximum investment was _____ lakh rupees.

- Ans
- 1. fifty
 - 2. five
 - 3. ten
 - 4. twenty

Q.44 The first Indian Factories Act 1881 was mainly related to which subject?

- Ans
- 1. Child labour
 - 2. Wages rate
 - 3. Woman labour
 - 4. Equal work equal pay

Q.45 As of the December 2022, which of the following cities of India was NOT a Railway Zone?

- Ans
- 1. Bilaspur
 - 2. Udaipur
 - 3. Jabalpur
 - 4. Hajipur

Q.46 Which of the following new words were added to Indian Constitution by the 42nd Constitutional Amendment Act?

- A. Socialist
- B. Integrity
- C. Fraternity
- D. Secular
- E. Equality

- Ans
- 1. A, D and E only
 - 2. A, C and D only
 - 3. B, C and D only
 - 4. A, B and D only

Q.47 Who was the leader of the French forces during the second Carnatic War?

- Ans
- 1. Joseph Francois Dupleix
 - 2. Albert Newman
 - 3. Daniel Samuel
 - 4. John Ferro

Q.48 'Azadi ka Amrit Mahotsav' started how many weeks before the 15th August 2023 celebration?

- Ans
- 1. 50 weeks
 - 2. 75 weeks
 - 3. 25 weeks
 - 4. 100 weeks

Q.49 In which state is the Seshachalam Biosphere Reserve located?

- Ans
- 1. Maharashtra
 - 2. Andhra Pradesh
 - 3. Tamil Nadu
 - 4. Gujarat

Q.50 In which case did the court rule that Parliament CANNOT amend the basic structure of the Constitution?

- Ans
- 1. Ashok Mehta Case
 - 2. Kesavananda Bharti Case
 - 3. Balbir Mehta Case
 - 4. Golaknath Case

Section : Reasoning

Q.1 Select the option that is related to the third word in the same way as the second word is related to the first word. (The words must be considered as meaningful English words and must NOT be related to each other based on the number of letters/number of consonants/vowels in the word)

Swing : Garden :: Stars : ?

- Ans
- 1. Sun
 - 2. Light
 - 3. Camera
 - 4. Sky

Q.2 How many triangles are there in the given figure?

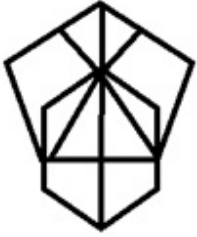

- Ans
- 1. 5
 - 2. 4
 - 3. 6
 - 4. 7

Q.3 Select a figure from amongst the four given options which, when placed in the blank space of figure (X), would complete the pattern.

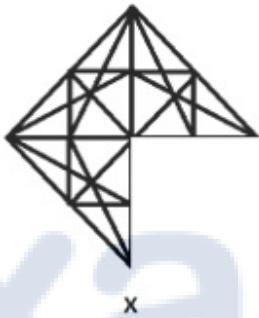

- Ans
- 1.
 - 2.
 - 3.
 - 4.

Q.4 In a certain code language, 'BELONG' is written as 'DVTLRT' and 'STUDIO' is written as 'MGKWWL'. How will 'UPDATE' be written as in that language?

- Ans
- 1. KKBZLV
 - 2. KPRBUS
 - 3. KLRZBL
 - 4. KJLDFO

Q.5 Select the option that is related to the fourth term in the same way as the first term is related to the second term : term is related to the sixth term.
98 : 9 :: ? : 13 :: 458 : 21

- Ans
- 1. 185
 - 2. 158
 - 3. 168
 - 4. 186

Q.6 Select the number from among the given options that can replace the question mark (?) in the following series.

1, 13, 85, 517, 3109, ?

- Ans
- 1. 19834
 - 2. 31456
 - 3. 18661
 - 4. 18000

Q.7 Which figure should replace the question mark (?) in the following series to continue the pattern?

N C E R S T V	R N V C E S T T	T E C V N T V R	N E R C S T V	?
---------------------------------	--------------------------------------	--------------------------------------	---------------------------------	---

Ans

- 1.

V		N
C	E	
	R	
S		T
- 2.

S		V
N	E	
	R	
T		C
- 3.

T		S
C	E	
	R	
N		V
- 4.

V		N
C	R	
	E	
S		T

Q.8 Select the option in which the given figure is embedded (rotation is NOT allowed).



Ans

X 1.



X 2.

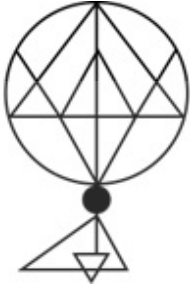

✓ 3.

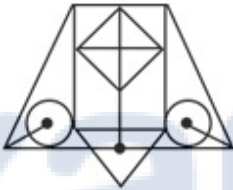

X 4.



Q.9 D, E, F, G, H, J and K were sitting in a straight row, facing north. J was exactly between H and E. Only K was to the right of F. Only G was to the left of D. H was to the immediate left of F. Who was to the immediate right of D?

Ans ✓ 1. E

X 2. H

X 3. J

X 4. F

Q.10 Select the correct mirror image of the given combination when the mirror is placed at MN as shown below.

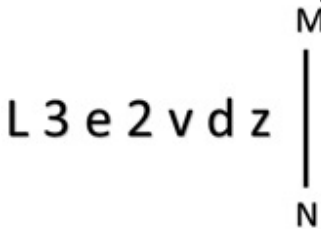

Ans

X 1. z ε 2 ε 3 v b J

X 2. z ε 2 v q z J

X 3. z ε 2 e 3 z J

✓ 4. z ε 2 v q z J

Q.11 Select the option figure in which the given figure is embedded as its part (rotation is NOT allowed).



Ans

✗ 1.

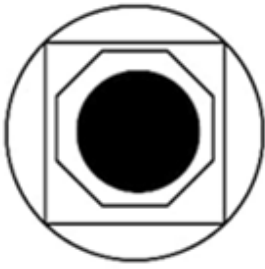

✓ 2.

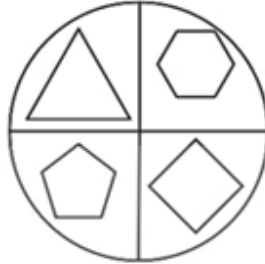

✗ 3.

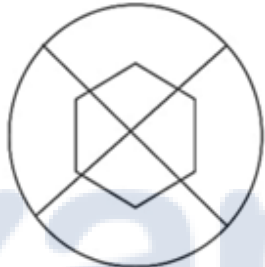

✗ 4.

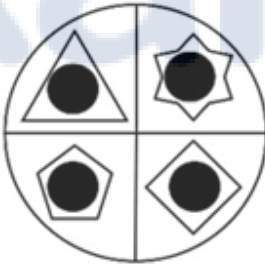

Q.12 Six numbers 1, 2, 3, 4, 5 and 6 are written on different faces of a dice. Two positions of this dice are shown in the figure. Find the number on the face opposite to '2'.

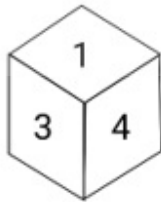
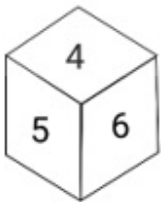

- Ans
- ✗ 1. 6
 - ✗ 2. 3
 - ✗ 3. 5
 - ✓ 4. 4

Q.13 Which figure should replace the question mark (?) if the following series were to be continued?

	V		E		S		V		E				
B	E	U	W	U	V	U	V	W	B	W	S	B	?
S	W		B	S		E	B		U	E		V	U

Ans

✓ 1.

		S
U	B	E
W	V	

✗ 2.

		E
S	U	B
W	V	

✗ 3.

		V
S	B	W
E	U	

✗ 4.

		U
S	B	W
E	V	

Q.14 Select the correct mirror image of the given figure when the mirror is placed at PQ as shown below.

ARC(-=ANE_? | P
Q

Ans

✓ 1.

ARC(-=ANE_?

✗ 2.

ARC(-=ANE_?

✗ 3.

ARC(-=ANE_?

✗ 4.

ARC(-)ANE_?

Q.15 Select the set in which the numbers are related in the same way as are the numbers of the given sets.
 (NOTE: Operations should be performed on the whole numbers, without breaking down the numbers into its constituent digits. E.g., 13 – Operations on 13 such as adding/ deleting/ multiplying etc. to 13 can be performed. Breaking down 13 into 1 and 3 and then performing mathematical operations on 1 and 3 is not allowed.)
 (428, 150, 278)
 (401, 139, 262)

- Ans**
- 1. (349, 145, 206)
 - 2. (245, 213, 122)
 - 3. (389, 183, 206)
 - 4. (191, 891, 118)

Q.16 Select the correct mirror image of the given figure when the mirror is placed at PQ as shown below.



- Ans**
- 1. F 3 S d k B 7 w x
 - 2. x w 7 B k B 7 w x
 - 3. x w 7 B k B 7 w x
 - 4. F 3 S d k B 7 w x

Q.17 Choose the dice from the given options that is similar to the dice formed from the given sheet of paper (X).

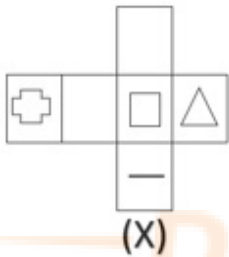

- Ans**
- 1. [Die with cross, triangle, vertical line]
 - 2. [Die with horizontal line, vertical line, triangle]
 - 3. [Die with cross, square, vertical line]
 - 4. [Die with square, vertical line]

Q.18 1, 2, 3, 4, 5 and 6 are written on different faces of a dice. Three different positions of the same dice are shown below. Find the number on the face opposite to the one showing '6'.

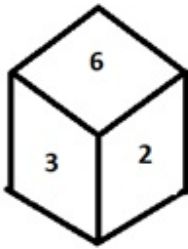

figure 1

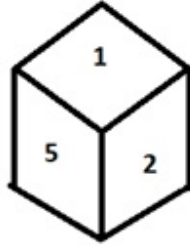

figure 2

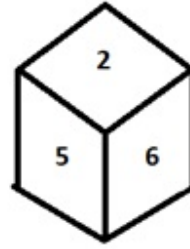

figure 3

- Ans
- 1. 4
 - 2. 5
 - 3. 1
 - 4. 2

Q.19 Select the correct combination of mathematical signs to sequentially replace the * signs and to balance the given equation.
 $20 * 96 * 66 * 11 * 10 * 56$

- Ans
- 1. +, -, +, =, x
 - 2. -, x, +, +, =
 - 3. +, -, +, x, =
 - 4. -, +, +, x, =

Q.20 Two statements are given followed by two conclusions numbered I and II. Assuming the statements to be true, even if they seem to be at variance from commonly known facts, decide which of the conclusions logically follow(s) from the statements.

Statements:

Some Bags are Waters.

All Waters are Liquids.

Conclusions:

I. Some Liquids are Bags.

II. All Bags are Liquids.

- Ans
- 1. Only conclusion II follows.
 - 2. Both conclusions I and II follow.
 - 3. Neither conclusion I nor II follows.
 - 4. Only conclusion I follows.

Q.21 Six numbers, 1, 2, 3, 4, 5 and 6, are written on the different faces of a dice. Three different positions of the same dice are shown (Figures 1-3). Find the number on the face opposite to the face showing '3'.

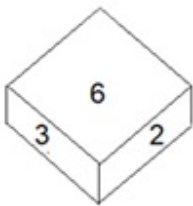

Figure 1

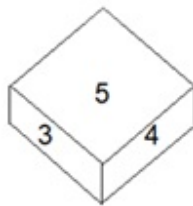

Figure 2

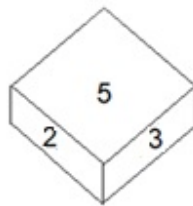

Figure 3

- Ans
- 1. 2
 - 2. 5
 - 3. 4
 - 4. 1

Q.22 Which of the following interchanges of signs would make the given equation correct?
 $7 - 4 \times 40 \div 5 + 6 = 51$

- Ans
- 1. - and +
 - 2. ÷ and ×
 - 3. - and ×
 - 4. + and ×

Q.23 Which of the following terms will replace the question mark (?) in the given series?
 GOM, INO, KMQ, MLS, ?

- Ans
- 1. OJV
 - 2. NKV
 - 3. OKU
 - 4. NJU

Q.24 A square sheet of paper is folded along the dotted line successively along the directions shown and is then punched in the last. How would the paper look when unfolded?

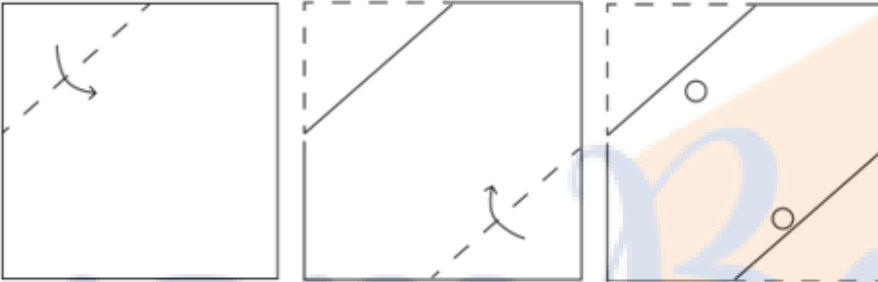

Ans

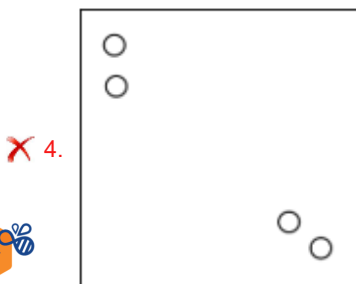
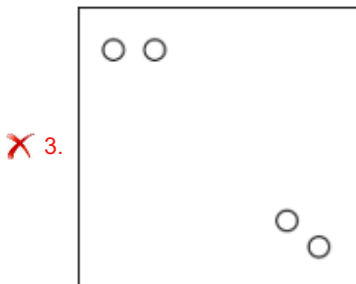
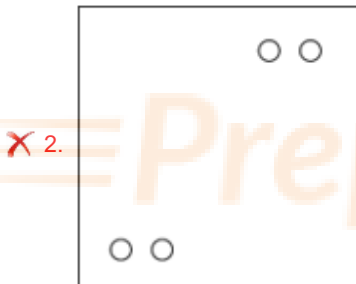
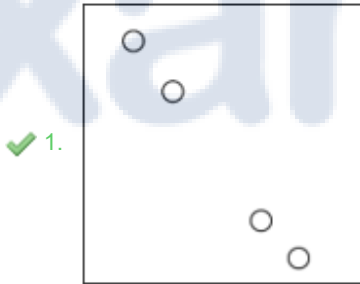

Q.25 Select the figure from among the given options that can replace the question mark (?) in the following series.

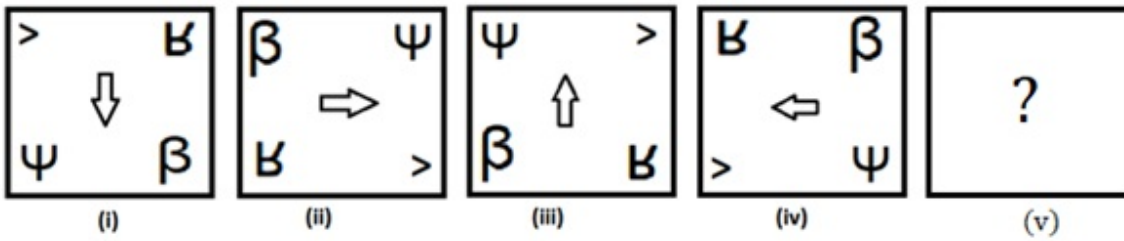

Ans

- 1.
- 2.
- 3.
- 4.

Section : Numerical Ability

Q.1 In a circular race on a track of length 2000 m, X and Y start from the same point at the same time in opposite direction at the speeds of 15 km/h and 33 km/h, respectively. After how much time will they meet next?

- Ans
- 1. 400 sec
 - 2. 250 sec
 - 3. 300 sec
 - 4. 275 sec

Q.2 If $\frac{1}{a} : \frac{1}{b} : \frac{1}{c} = 2 : 3 : 5$, then $a : b : c$ is equal to:

- Ans
- 1. 15 : 10 : 12
 - 2. 15 : 10 : 6
 - 3. 2 : 4 : 5
 - 4. 6 : 10 : 15

Q.3 The diameter of a solid cylinder is 28 cm and its height is 20 cm Find the total surface area (in cm^2) of the cylinder. (Use $\pi = \frac{22}{7}$)

- Ans
- 1. 2990
 - 2. 2992
 - 3. 2993
 - 4. 2991

Q.4 Raju lost 13% by selling a radio set for ₹4,524. What percentage of profit would he have earned by selling it for ₹ (rounded off to two decimal places)?

- Ans
- 1. 28.52%
 - 2. 23.08%
 - 3. 21.05%
 - 4. 25.25%

Q.5 The average of the marks of Ram, Ramesh, Somesh and Soham in mathematics is 75, and the average of the marks of Ramesh, Somesh, Soham and Mohan in mathematics is 80. The marks scored by Mohan alone in mathematics is 70. Find the marks scored by Ram alone in mathematics.

- Ans
- 1. 62
 - 2. 45
 - 3. 50
 - 4. 78

Q.6 The curved surface area of a right circular cone of radius 21 cm is 1518 cm^2 . What is the slant height of the cone? (Use $\pi = \frac{22}{7}$)

- Ans
- 1. 27 cm
 - 2. 25 cm
 - 3. 23 cm
 - 4. 21 cm

Q.7 तीन अभाज्य संख्याओं का योगफल 72 है। यदि उनमें से एक संख्या दूसरी संख्या से 24 अधिक है, तो उनमें से एक संख्या कौन-सी है?

- Ans
- 1. 31
 - 2. 37
 - 3. 29
 - 4. 47

Q.8 If the diameter of a circle is increased by 24%, then the percentage increase in the area is:

- Ans
- 1. 48.28%
 - 2. 50.46%
 - 3. 64.34%
 - 4. 53.76%

Q.9 The number of prime numbers which are greater than 100 and less than 150 is:

- Ans
- 1. 11
 - 2. 9
 - 3. 10
 - 4. 8

Q.10 Dileep and Rajesh can complete a work separately in 20 days and 30 days, respectively. In how many days will the entire work be completed, if they work on an alternate basis, starting with Rajesh?

- Ans
- 1. 12
 - 2. 22
 - 3. 28
 - 4. 24

Q.11 A shopkeeper offers a scheme on the purchase of shirts: 'Buy two, get one free of the same kind'. The cost price shirt is ₹300. What should be the selling price (in ₹) of one shirt if he wants to earn 30% profit?

- Ans
- 1. 585
 - 2. 535
 - 3. 485
 - 4. 435

Q.12 12 फुट लम्बे वर्गाकार बोर्ड की एक भुजा से 4 फुट लम्बाई का एक टुकड़ा काटा जाता है। बोर्ड के क्षेत्रफल में कितने प्रतिशत की कमी होती है?

- Ans
- 1. 27.27%
 - 2. 30.33%
 - 3. 33.33%
 - 4. 13.33%

Q.13 A man invests ₹5,000 for 3 years at compound interest. After one year, the money amounts to ₹5,450. What will be the amount (to the nearest rupee) due at the end of 3 years?

- Ans
- 1. ₹6,475
 - 2. ₹7,405
 - 3. ₹5,575
 - 4. ₹6,970

Q.14 An amount of ₹2,500 is divided into two parts in such a way that, if one part is put out at 5% p.a. simple interest and the other at 6% p.a., then the yearly annual interest will be ₹140. How much is lent at 5% p.a.?

- Ans
- 1. ₹500
 - 2. ₹1,000
 - 3. ₹1,500
 - 4. ₹2,000

Q.15 The value of $\frac{(11.12)^2 - (8.12)^2}{(0.3)^2 + (0.3)(18.94)}$ is:

- Ans
- 1. 100
 - 2. 0.1
 - 3. 10
 - 4. 1

Section : Computer Proficiency

Q.1 Which of the following shortcut keys is used to modify selected text as Italic in MS-Word 365?

- Ans
- 1. Ctrl + O
 - 2. Ctrl + I
 - 3. Ctrl + U
 - 4. Ctrl + B

Q.2 Which of the following statements is INCORRECT related to sorting emails in Gmail?

- Ans
- 1. Sorting mail cannot help us remove unwanted emails from our inboxes and more easily unsubscribe from mailings we don't need.
 - 2. Sorting mail can help us remove unwanted emails from your inbox and more easily unsubscribe from mailings we don't need.
 - 3. We can sort emails by a variety of factors, like the topic, sender, size, or age of the message.
 - 4. Depending on what we use your email address for, sorting emails can also help you keep track of trends and correspondence by looking at messages sorted by specific criteria.

Q.3 In MS Excel 365 which file type used in MS Excel produces a comma-delimited text file that can be read by almost all spreadsheet applications on any operating system?

- Ans**
- 1. .xlsx
 - 2. .docx
 - 3. .pdf
 - 4. .csv

Q.4 _____ involves using a smartphone's data connection to provide internet access to other devices such as laptops or tablets.

- Ans**
- 1. Wi-Fi
 - 2. Tethering
 - 3. Dial up
 - 4. Satellite

Q.5 Which Microsoft Excel 365 function calculates the average of a range of numbers?

- Ans**
- 1. MEDIAN
 - 2. MEAN
 - 3. AVERAGE
 - 4. AVG

Q.6 In Microsoft Word 365, which option is used to save an existing document with a new name or in a different location?

- Ans**
- 1. Save
 - 2. Print
 - 3. Save As
 - 4. Copy

Q.7 Suppose you have a worksheet in MS Excel 365 containing sales data for different months. You need to update the sales figure for May, as there was an error in the initial entry. What steps should you follow to edit the sales data for the month of May?

- Ans**
- 1. Click on the cell containing the May sales data -> Press F1 to enter edit mode -> Make the necessary changes -> Press Enter to confirm the edit
 - 2. Click on the cell containing the May sales data -> Press F2 to enter edit mode -> Make the necessary changes -> Press Enter to confirm the edit
 - 3. Click on the cell containing the May sales data -> Press F6 to enter edit mode -> Make the necessary changes -> Press Enter to confirm the edit
 - 4. Click on the cell containing the May sales data -> Press F7 to enter edit mode -> Make the necessary changes -> Press Enter to confirm the edit

Q.8 What does the 'Paste' command do in Microsoft Word 365?

- Ans**
- 1. Removes the selected text
 - 2. Deletes the content of the clipboard
 - 3. Copies the selected text to the clipboard
 - 4. Inserts the content from the clipboard into the document

Q.9 Which option allows you to select multiple documents while opening them in Microsoft Word 365?

- Ans**
- 1. Hold down the Tab key while clicking on the documents.
 - 2. Hold down the Alt key while clicking on the documents.
 - 3. Hold down the Windows key while clicking on the documents.
 - 4. Hold down the Shift key while clicking on the documents.

Q.10 Which option in MS-Word 365 allows you to align the text in a paragraph to both the left and right margins, creating a visually appealing document?

Ans 1. Paragraph Alignment

2. Justification

3. Text Indentation

4. Line Spacing



Prepare 50% Faster

Constable Executive Male and Female in Delhi Police Examination 2023

Exam Date	17/11/2023
Exam Time	12:00 PM - 1:30 PM
Subject	Constable Executive Male and Female in Delhi Police Examination 2023

Section : General Knowledge

Q.1 Which foreign power made the Indian pepper trade a royal monopoly?

- Ans**
- 1. The Spanish
 - 2. The French
 - 3. The Portuguese
 - 4. The Dutch

Q.2 Part XIX of the Indian Constitution deals with:

- Ans**
- 1. elections
 - 2. emergency provisions
 - 3. miscellaneous
 - 4. amendment of the Constitution

Q.3 Famous dance personality Rajarshi Bhagya Chandra is also known as:

- Ans**
- 1. Rewa Prasad Dwivedi
 - 2. Bharat Muni
 - 3. Ningthou Ching-Thang Khomba
 - 4. Bhasa

Q.4 How many writs are guaranteed under Article 32 of the Indian Constitution?

- Ans**
- 1. Five
 - 2. Four
 - 3. Seven
 - 4. Six

Q.5 Which method is used to separate ribosomes from the cell?

- Ans**
- 1. Distillation
 - 2. Filtration
 - 3. Ultracentrifugation
 - 4. Chromatography

Q.6 Who was the author of the book titled 'Poverty and Un-British Rule in India'?

- Ans**
- 1. Dadabhai Naoroji
 - 2. Mahatma Gandhi
 - 3. Sardar Vallabhbhai Patel
 - 4. Subhash Chandra Bose

Q.7 Who among the following Gurus of Sikh religion was the last Guru?

- Ans
- 1. Guru Hargobind
 - 2. Guru Amar Das
 - 3. Guru Angad
 - 4. Guru Gobind Singh

Q.8 Who among the following received, in 1997, the Japan Art Association's Praemium Imperiale prize for music?

- Ans
- 1. Ustad Bismillah Khan
 - 2. Pandit Shiv Kumar Sharma
 - 3. Pandit Ravi Shankar
 - 4. Ustad Allarakha Khan

Q.9 In the year 2017, which of the following countries hosted the Under-17 Football World Cup?

- Ans
- 1. Thailand
 - 2. United Arab Emirates
 - 3. India
 - 4. United States of America

Q.10 As per Census 2011, which Indian demographic group typically exhibits a higher literacy rate?

- Ans
- 1. Rural females
 - 2. Rural males
 - 3. Urban females
 - 4. Urban males

Q.11 Which of the following was NOT an effect of devaluation of the rupee in 1991 to make an international adjustment of Indian currency?

- Ans
- 1. Raised the influx of foreign capital
 - 2. Increased imports
 - 3. Increased exports
 - 4. Decreased imports

Q.12 In Indo Islamic construction, _____ and lime mortar was an important factor in construction.

- Ans
- 1. wood
 - 2. mud
 - 3. concrete
 - 4. stone

Q.13 The Index of Industrial Production (IIP) is an index that shows the growth rates in different industry groups of the economy in a fixed period of time. What is the base year of IIP?

- Ans
- 1. 2012-13
 - 2. 2004-05
 - 3. 2011-12
 - 4. 2010-11

Q.14 In Ancient India, which of the following dynasties was empowered in Deccan by Gautamiputra Satakarni?

- Ans
- 1. Saka
 - 2. Kushana
 - 3. Satavahana
 - 4. Pahlava

Q.15 Which of the following festivals is celebrated primarily by the Parsi Community?

- Ans**
- 1. Songkran
 - 2. Jashan-e-Mihragan
 - 3. Deepawali
 - 4. Milad-un-Nabi

Q.16 A new phase of which initiative of the Government of India was launched in 2022 with the overall vision of creating 'Garbage Free Cities' and with the new component of wastewater treatment including faecal sludge management?

- Ans**
- 1. Rural Open Defecation Free Initiative
 - 2. Wastewater Management Framework in India
 - 3. Swachh Bharat Mission (Urban) 3.0
 - 4. Swachh Bharat Mission (Urban) 2.0

Q.17 Which of the following causes the Tsunami waves?

- Ans**
- 1. Interior of the earth
 - 2. Exterior of the earth
 - 3. Interior of the moon
 - 4. Exterior of the moon

Q.18 In the year 2021-22, which country was the largest importer of Jute from India?

- Ans**
- 1. Italy
 - 2. USA
 - 3. Japan
 - 4. France

Q.19 Where are the Ellora caves located?

- Ans**
- 1. Indore
 - 2. Aurangabad
 - 3. Delhi
 - 4. Fatehpur Sikri

Q.20 Vijayalaya, who belonged to the ancient chiefly family of the Cholas from Uraiyur, captured the delta from the Muttaraiyar in the middle of the 9th century and built the town of _____.

- Ans**
- 1. Thanjavur
 - 2. Vengi
 - 3. Darasuram
 - 4. Kanchipuram

Q.21 The decennial census of India is conducted under which Census Act?

- Ans**
- 1. Census Act 1948
 - 2. Census Act 2010
 - 3. Census Act 2001
 - 4. Census Act 1955

Q.22 Which of the following percussion instruments is used in the popular folk dance 'Lavani'?

- Ans**
- 1. Dholak
 - 2. Xylophone
 - 3. Sleigh Bells
 - 4. Piano

Q.23 The Chairman of the State Public Service Commission can be removed by:

- Ans
- 1. The Prime Minister of India
 - 2. The Governor of the State
 - 3. The President of India
 - 4. The Chief Minister of the State

Q.24 As of November 2022, in which of the following periods in Indian history was the Republic Day parade NOT performed at the Rajpath(now called Kartavya Path)?

- Ans
- 1. 1950-1954
 - 2. 2000-2004
 - 3. 2006-2008
 - 4. 1990-1994

Q.25 Which of the following writs is issued by the Court to order a public official to properly perform his/her official duties or correct an abuse of an action?

- Ans
- 1. Prohibition
 - 2. Habeas corpus
 - 3. Mandamus
 - 4. Quo-warranto

Q.26 _____ is the largest employer of labour force in India.

- Ans
- 1. Financial Services Sector
 - 2. Cottage Industries
 - 3. Agriculture
 - 4. Small Scale Industries

Q.27 Set in the holy city of Varanasi, 'Kashi Ka Assi' is written by:

- Ans
- 1. Kamleshwar
 - 2. Amrita Pritam
 - 3. Kashi Nath Singh
 - 4. Kedar Nath Singh

Q.28 Who among the following wrote, 'The Autobiography of an Unknown Indian'?

- Ans
- 1. Nirad C Chaudhuri
 - 2. Swami Rama
 - 3. Prakash Tandon
 - 4. BR Ambedkar

Q.29 Which of the following parts of the Indian Constitution deals with the Directive Principles of State Policy?

- Ans
- 1. Part IV
 - 2. Part XX
 - 3. Part XIV
 - 4. Part XI

Q.30 According to Census of India 2011, which union territories have the lowest literacy rate?

- Ans
- 1. Andaman and Nicobar
 - 2. Lakshadweep
 - 3. Dadra and Nagar Haveli
 - 4. Chandigarh

Q.31 It was decided to celebrate the Republic day on 26th January every year by the Constitution makers to pay homa 'Purna Swaraj' declaration which was promulgated on _____.

- Ans
- 1. 26th January 1929
 - 2. 26th January 1931
 - 3. 26th January 1930
 - 4. 26th January 1932

Q.32 In which year was the Basketball Federation of India established?

- Ans
- 1. 1920
 - 2. 1951
 - 3. 1950
 - 4. 1947

Q.33 Correctly match the following Indian season with their crops:

Season	Crop
1. Kharif	a. Fodder
2. Rabi	b. Wheat
3. Zaid	c. Rice

- Ans
- 1. 1-c, 2- b, 3-a
 - 2. 1-c, 2- a, 3-b
 - 3. 1-b, 2- c, 3-a
 - 4. 1-a, 2- b, 3-c

Q.34 The Rajas(kings) did not have capital cities, palaces or regular armies, nor did they collect taxes during the _____ period.

- Ans
- 1. Huna
 - 2. Rigvedic
 - 3. Shunga
 - 4. Mauryan

Q.35 Alarjel Valli and Rukmini Devi Arundale are associated with which of the following styles of Indian Dances?

- Ans
- 1. Kathak
 - 2. Kuchipudi
 - 3. Bharatanatyam
 - 4. Kathakali

Q.36 What is the deepest, vegetation-free, and muddy zone of a pond ecosystem called?

- Ans
- 1. The profundal zone
 - 2. The lotic zone
 - 3. The tropical zone
 - 4. The temperate zone

Q.37 Which of the following Peninsular rivers flows westward?

- Ans
- 1. Kaveri
 - 2. Godavari
 - 3. Narmada
 - 4. Krishna

Q.38 Totaram Sharma, Pandit Ayodhya Prasad, Gopal Das and Babu Ram Shanker Pagaldas are noted players of which following instruments?

- Ans
- 1. Sarangi
 - 2. Pakhawaj
 - 3. Mridangam
 - 4. Sarod

Q.39 To file the nomination for the post of Vice President, the candidate must be proposed by at least _____ electors.

- Ans
- 1. 40
 - 2. 25
 - 3. 20
 - 4. 30

Q.40 Who among the following was not among the convicts sentenced to death by the British Government of India in the Lahore conspiracy case?

- Ans
- 1. Udham Singh
 - 2. Shivaram Rajguru
 - 3. Bhagat Singh
 - 4. Sukhdev Thapar

Q.41 Net national product at market price can be defined as:

- Ans
- 1. Gross national product at market price plus depreciation
 - 2. Net domestic product at market price minus depreciation
 - 3. Net domestic product at market price plus net income from abroad
 - 4. Net domestic product at market price minus net income from abroad

Q.42 Who popularised the movement of Theosophical Society in India?

- Ans
- 1. Swami Vivekananda
 - 2. Ramkrishna Bhandarkar
 - 3. Keshav Chandra Sen
 - 4. Annie Besant

Q.43 When did India win its last gold medal in Hockey in the Olympics?

- Ans
- 1. 1980
 - 2. 1976
 - 3. 1972
 - 4. 1968

Q.44 Which of the following is NOT a component of fiscal reforms?

- Ans
- 1. Taxation reforms
 - 2. Public expenditure reforms
 - 3. Control of public debt
 - 4. Change in interest rate

Q.45 Select the personality who received the Sangeet Natak Akademi 2021 award for his/her contribution in Kuchipudi.

- Ans
- 1. Bijay Kumar Jena
 - 2. N Sailaja
 - 3. Bhuvan Kumar
 - 4. Kalamandalam Girija

Q.46 Who among the following is the first ever recipient of Rajiv Gandhi Khel Ratna Award?

- Ans**
- 1. Dhyan Chand
 - 2. Vishwanathan Anand
 - 3. Virat Kohli
 - 4. Sunil Chhetri

Q.47 A baking student started baking a cake. After some time he realised his cake was not rising and hard. This is because he forgotten to add the following ingredient:

- Ans**
- 1. more cake flour
 - 2. baking powder
 - 3. vanilla extract
 - 4. milk

Q.48 Which of the following is the most dominant flora of the plant kingdom?

- Ans**
- 1. Gymnosperm
 - 2. Angiosperm
 - 3. Bryophyta
 - 4. Pteridophyte

Q.49 Which of the following is INCORRECT with respect to repo rate?

- Ans**
- 1. It is a single policy rate to signal the stance of monetary policy to achieve macro-economic objectives of growth with price stability.
 - 2. It is the rate at which the commercial banks borrow funds from the RBI.
 - 3. It is a policy rate which is the key lending rate of the central bank, and its nomenclature varies from country to country.
 - 4. It is the rate at which banks place their funds with the RBI and receive collateral.

Q.50 Which region is the source of basaltic magma?

- Ans**
- 1. The core
 - 2. Lower mantle
 - 3. Upper mantle
 - 4. Transition region

Section : Reasoning

Prepare 50% Faster

Q.1 Select the figure from the given options that will replace the question mark (?) in the figure given below to complete the pattern.

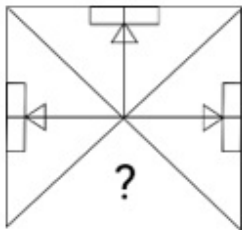

Ans

X 1.



✓ 2.

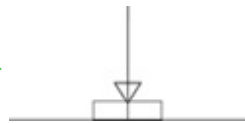

X 3.

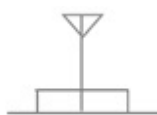

X 4.

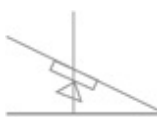

Q.2 Select the combination of letters that when sequentially placed in the blanks of the given series will complete the series.
TP_BD_T_R__QT_RB_Q__PRB__T__BDQ

Ans

X 1. RQPBPRDPBDTR

X 2. PBPRDTRQDPBR

✓ 3. RQPBPDPTDQPR

X 4. PBPTRQRDDPBR

Q.3 Select the option figure that will replace the question mark (?) in the figure given below to complete the pattern.

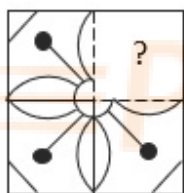

Ans

X 1.

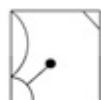

✓ 2.



X 3.

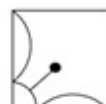

X 4.

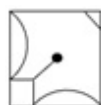

Q.4 How many triangles are there in the given figure?

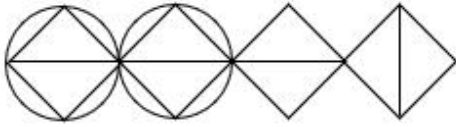

- Ans
- 1. 7
 - 2. 9
 - 3. 8
 - 4. 6

Q.5 Six students, Ram, Gopi, Sita, Vimal, Tony and John, are sitting in a straight row facing north. Only two people sit to the left of Sita. Only two people sit between Sita and Vimal. Ram sits to the immediate right of Tony. Gopi sits to the immediate left of John. John is not a neighbour of Vimal. Who sits second from the extreme left end of the row?

- Ans
- 1. Ram
 - 2. Vimal
 - 3. John
 - 4. Tony

Q.6 Select the correct combination of mathematical signs to sequentially replace the * signs and to balance the given equation.
 $16 * 4 * 20 * 82 * 14 * 148$

- Ans
- 1. $\div \times + = -$
 - 2. $\div \times + - =$
 - 3. $\div + \times - =$
 - 4. $\times \div + - =$

Q.7 Six numbers 1, 2, 3, 4, 5 and 7 are written on different faces of a dice. Two positions of this dice are shown in the figure. If both the even numbers are written on opposite faces of the dice, find the number on the face opposite to '1'.

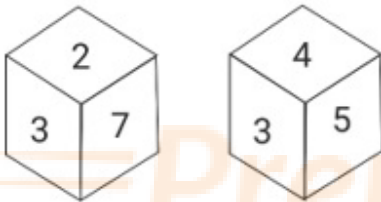

- Ans
- 1. 3
 - 2. 7
 - 3. 5
 - 4. 2

Q.8 Six letters L, M, N, O, P and Q are written on different faces of a dice. Two different positions of this dice are shown in the figure. Select the letter that will be on the face opposite to the one having O.

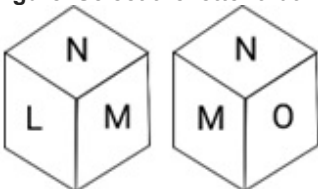

- Ans
- 1. N
 - 2. P
 - 3. Q
 - 4. L

Q.9 Read the given statements and conclusions carefully. Assuming that the information given in the statements is true, it appears to be at variance with commonly known facts, decide which of the given conclusions logically follow(s) from the statements.

Statements:

All pens are laptops.

All laptops are computers.

Conclusions:

I. All pens are computers.

II. All laptops are pens.

- Ans**
- ✓ 1. Only conclusion I follows
 - ✗ 2. Only conclusion II follows
 - ✗ 3. Neither conclusion I nor II follows
 - ✗ 4. Both conclusions I and II follow

Q.10 Select the option figure that will replace the question mark (?) in the figure given below to complete the pattern.



Ans

✓ 1.

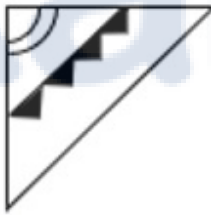

✗ 2.



✗ 3.

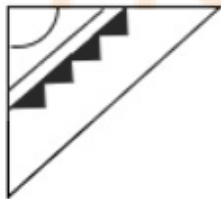

✗ 4.



Q.11 Each of the following questions consists of 4 figures marked 1, 2, 3 and 4 called the Problem Figures followed by 4 other figures. Select a figure from amongst the Answer Figures which will continue the same series as established by the four Problem Figures.

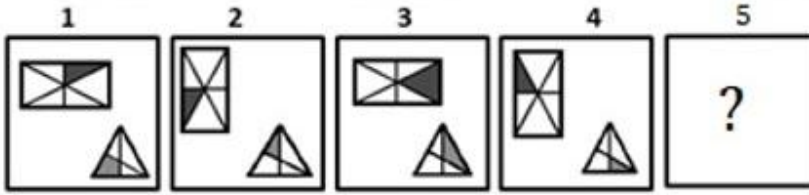

Ans

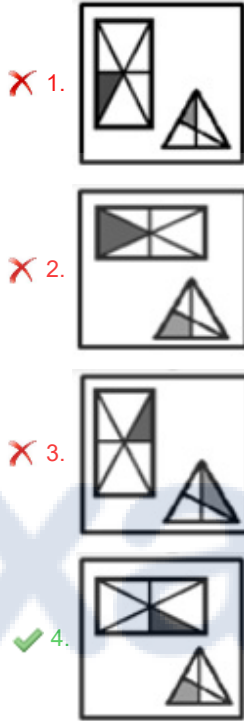

Q.12 Select the option that is related to the fifth letter-cluster in the same way as the second letter-cluster is related to the first letter-cluster and the fourth letter-cluster is related to the third letter-cluster.
GIVE : JLYH :: TAKE : WDNH :: COPY : ?

- Ans
- ✓ 1. FRSB
 - ✗ 2. FRSC
 - ✗ 3. ERSB
 - ✗ 4. FRRC

Q.13 A cube (dice) has six different numbers drawn over its six faces. Three different positions of this cube are shown in the given figure. Which number is on the face opposite to '1'?

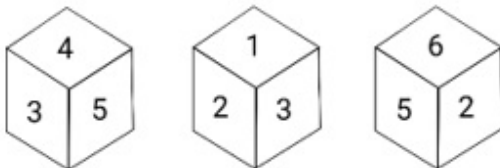

- Ans
- ✗ 1. 4
 - ✓ 2. 5
 - ✗ 3. 6
 - ✗ 4. 2

Q.14 Select the option that is related to the fourth term in the same way as the first term is related to the second term : term is related to the sixth term.
70 : 625 :: ? : 144 :: 37 : 196

- Ans
- 1. 35
 - 2. 45
 - 3. 31
 - 4. 41

Q.15 Which of the following option figures will complete the pattern in the figure given below?

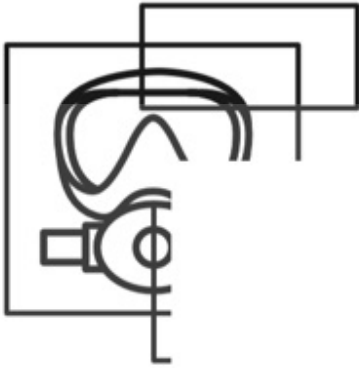

Ans

- 1.
- 2.
- 3.
- 4.

Q.16 Select the number from among the given options that can replace the question mark (?) in the following series.
4, 10, 17, 25, ?, 44

- Ans
- 1. 33
 - 2. 31
 - 3. 32
 - 4. 34

Q.17 Which two signs should be interchanged to make the following equation correct?

$$99 \div 8 + 2 - 16 \times 4 = 39$$

- Ans
- ✓ 1. \div and $+$
 - ✗ 2. \div and $-$
 - ✗ 3. $-$ and \times
 - ✗ 4. \times and $+$

Q.18 Select the correct mirror image of the given combination when the mirror is placed at 'PQ' as shown below.



- Ans
- ✓ 1. 7 D S L Z C
 - ✗ 2. 7 D S L Z C
 - ✗ 3. 7 D S L Z C
 - ✗ 4. 7 D S L Z C

Q.19 Select a figure from amongst the four given options which, when placed in the blank space of figure (X), would complete the pattern.



X

- Ans
- ✗ 1.
 - ✗ 2.
 - ✓ 3.
 - ✗ 4.

Q.20 Select the set in which the numbers are related in the same way as are the numbers of the following sets.
 (NOTE : Operations should be performed on the whole numbers, without breaking down the numbers into its con-
 digits. E.g. 13 – Operations on 13 such as adding /deleting /multiplying etc. to 13 can be performed. Breaking dov
 and 3 and then performing mathematical operations on 1 and 3 is NOT allowed)
 (4, 39), (5, 100)

- Ans**
- ✓ 1. (3, 2)
 - ✗ 2. (6, 192)
 - ✗ 3. (9, 684)
 - ✗ 4. (12, 153)

Q.21 Which figure should replace the question mark (?) in the following series to continue the pattern?

7	P	8	S	
X 8 A	8 A ♥	A ♥ P	♥ P Y	?
♥	X	Y	A	

Ans

✗ 1.

Y
S ♥ P
6

✗ 2.

P
Y S ♥
6

✓ 3.

♥
P Y S
6

✗ 4.

A
P Y ♥
S

Q.22 Which figure should replace the question mark (?) if the following series were to be continued?

B	2	6	2	6	4	♡	8	Y	8	Y	S	6	2	T	
	4			8			S			2			4		?
8	♡	S	♡	S	Y	2	6	4	6	4	T	8	Y	S	

Ans

✗ 1.

S	6	2
	T	
4	8	Y

✗ 2.

2	T	4
	8	
Y	S	6

✓ 3.

2	T	4
	8	
Y	S	9

✗ 4.

9	6	2
	T	
4	8	Y

Prepare 50% Faster

Q.23 Select the figure from the given options that will replace the question mark (?) in the figure given below and complete the pattern.

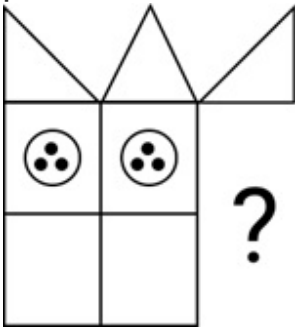

Ans

- ✓ 1.
- ✗ 2.
- ✗ 3.
- ✗ 4.

Q.24 In a certain code language, 'EXIT' is written as 'FJYU' and 'HIDE' is written as 'IEJF'. How will 'GAME' be written in that language?

- ✗ 1. HBNF
- ✗ 2. FBND
- ✗ 3. FNBD
- ✓ 4. HBNF

Q.25 A paper is folded and cut as shown below. How will it appear when unfolded?

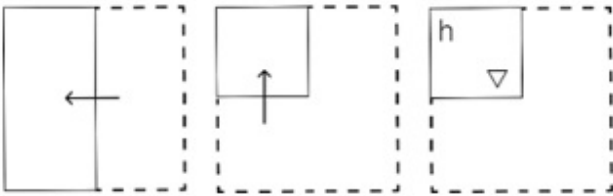

Ans

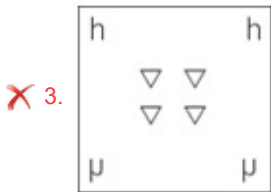
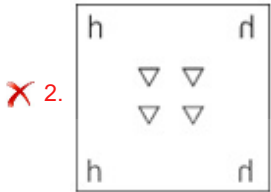
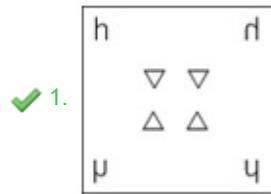

Section : Numerical Ability

Q.1 After successive discounts of 15% and 20%, an article was sold for ₹680. What is the marked price of the article?

- Ans
- ✗ 1. ₹2,000
 - ✓ 2. ₹1,000
 - ✗ 3. ₹1,500
 - ✗ 4. ₹3,000

Q.2 If the simple interest for 8 years is equal to 40% of the principal, then after how many years will it be equal to the principal?

- Ans
- ✗ 1. 25
 - ✓ 2. 20
 - ✗ 3. 18
 - ✗ 4. 15

Q.3 What will be the HCF of $(2 \times 2 \times 3 \times 3 \times 5 \times 7 \times 7 \times 11)$, $(2 \times 3 \times 3 \times 5 \times 11)$, $(2 \times 3 \times 3 \times 5 \times 7 \times 11 \times 11)$, $(2 \times 3 \times 3 \times 5 \times 5 \times 11)$, $(2 \times 3 \times 5 \times 7 \times 7)$?

- Ans
- ✓ 1. 30
 - ✗ 2. 66
 - ✗ 3. 42
 - ✗ 4. 105

Q.4 The selling price of an item is 15% more than the cost price and shopkeeper is able to earn ₹25. What is the selling price of the item?

- Ans
- 1. ₹177.67
 - 2. ₹181.67
 - 3. ₹166.67
 - 4. ₹191.67

Q.5 The ratio of the age of a father to that of his son is 7 : 4. If the product of their ages (in years) is 1008, then what is the ratio of the age of the father to that of the son after 10 years?

- Ans
- 1. 17 : 13
 - 2. 26 : 17
 - 3. 11 : 13
 - 4. 23 : 21

Q.6 A camp has provisions for 60 pupils for 18 days. In how many days will the same provisions finish off if the strength of the camp is increased to 72 pupils?

- Ans
- 1. 18 days
 - 2. 8 days
 - 3. 12 days
 - 4. 15 days

Q.7 Calculate the HCF of $\frac{1.75}{9}$, $\frac{5.6}{12}$ and $\frac{7}{18}$.

- Ans
- 1. $\frac{7}{180}$
 - 2. $\frac{13}{180}$
 - 3. $\frac{17}{180}$
 - 4. $\frac{11}{180}$

Q.8 It takes eight hours for a 600 km journey, if 120 km is done by train and the rest by car. It takes 20 minutes more, if 200 km is done by train and the rest by car. The ratio of the speed of the train to that of the cars is

- Ans
- 1. 1 : 2
 - 2. 1 : 3
 - 3. 3 : 4
 - 4. 2 : 3

Q.9 Kiran sells an object to Varun at a profit of 10%. Varun sells that object to Arun for ₹1,155 and makes a profit of 5%. At what cost did Kiran purchase the object?

- Ans
- 1. ₹1,500
 - 2. ₹1,000
 - 3. ₹2,500
 - 4. ₹2,000

Q.10 The price of a commodity increased by 22%. By what percentage (correct to two decimal places) should its consumption be reduced so that the total expenditure remains the same?

- Ans
- 1. 18.03%
 - 2. 19.89%
 - 3. 21.22%
 - 4. 20.03%

Q.11 A temple top is a hollow hemispherical dome with an inner radius of 2 units and an outer radius of 3 units. How much concrete (in cubic units) is used to make the top of the temple?

- Ans
- 1. $\frac{38\pi}{3}$
 - 2. $\frac{19\pi}{6}$
 - 3. $\frac{19\pi}{3}$
 - 4. $\frac{17\pi}{3}$

Q.12 The compound interest on a certain sum of money at 8% per annum for 3 years is ₹4,058. Find the simple interest on the same sum for 4 years at 10% p.a.

- Ans
- 1. ₹6,520
 - 2. ₹6,025
 - 3. ₹6,250
 - 4. ₹6,052

Q.13 The average of four numbers is 20, and one of these four numbers is 26. What is the average of the remaining three numbers?

- Ans
- 1. 17
 - 2. 18
 - 3. 16
 - 4. 19

Q.14 A hemisphere of lead of radius 8 cm is recast into a right circular cone of height 64 cm. Find the radius of the base of the cone. (Where $\pi = \frac{22}{7}$)

- Ans
- 1. 8 cm
 - 2. 4 cm
 - 3. $4\sqrt{2}$ cm
 - 4. $2\sqrt{2}$ cm

Q.15 Which of the following fractions is the smallest?

$$\frac{17}{21}, \frac{9}{11}, \frac{16}{19}, \frac{13}{15}$$

Ans

1. $\frac{9}{11}$

2. $\frac{17}{21}$

3. $\frac{16}{19}$

4. $\frac{13}{15}$

Section : Computer Proficiency

Q.1 Which of the following is used to move text from one location to another in a word document of MS-Word 365?

- Ans
- 1. Cut and paste the text at desired location
 - 2. Copy the selected text
 - 3. Copy and paste the text at desired location
 - 4. Select and cut the selected text

Q.2 How do you print a Microsoft Word 365 document?

- Ans
- 1. Select the Ready Printer command
 - 2. Select the Print command and then select 'OK'
 - 3. Select the Print command
 - 4. Select the Ready Printer command and then select 'OK'

Q.3 In MS Excel 365 which of the following keyboard shortcuts in MS Excel will allow us to open a new spreadsheet?

- Ans
- 1. Shift + N
 - 2. Alt + O
 - 3. Ctrl + O
 - 4. Ctrl + N

Q.4 Which of the following statements related to MS Word 365 is/are correct?

- 1) 'Save' allows you to update a previously saved file with new content.
- 2) 'Save As' allows you to save a new file or an existing file to a new place with the same name or a different name.

- Ans
- 1. Both (1) and (2)
 - 2. Only (2)
 - 3. Neither (1) nor (2)
 - 4. Only (1)

Q.5 In MS Excel 365, which of the following is NOT a benefit of creating a table in Microsoft Excel?

- Ans
- 1. Increased data integrity and accuracy
 - 2. Enhanced visual appeal and formatting
 - 3. Automatic filtering and sorting options
 - 4. Improved calculation capabilities

Q.6 A global network of interconnected computers and devices is called _____.

- Ans
- 1. Ethernet
 - 2. Internet
 - 3. Manet
 - 4. Intranet

Q.7 In MS Excel 365, to insert a new row above the selected row in Microsoft Excel 365, which command should you use?

- Ans
- 1. Delete Row
 - 2. Insert Column
 - 3. Insert Row
 - 4. Delete Column

Q.8 Which of the following is the correct option to convert text into superscript?

- Ans
- 1. Shift+S
 - 2. Ctrl+Shift+U
 - 3. Ctrl+Shift+S
 - 4. Ctrl+Shift+ +

Q.9 Which of the following is the correct structure of an email address?

- Ans
- 1. name@domain.com
 - 2. name_domain.com
 - 3. name.com
 - 4. name@com_domain

Q.10 In MS Word 365 If you want to print pages 1, 3, and 5 of a document, which of the following page ranges should you select?

- Ans
- 1. 1, 3-5
 - 2. 1, 3, 5
 - 3. 1-5
 - 4. 1-3, 5

Prepare 50% Faster

Constable Executive Male and Female in Delhi Police Examination 2023

Exam Date	17/11/2023
Exam Time	3:00 PM - 4:30 PM
Subject	Constable Executive Male and Female in Delhi Police Examination 2023

Section : General Knowledge

Q.1 Gandhiji participated in the _____ as a result of Gandhi-Irwin Pact.

- Ans**
- 1. First Round Table Conference
 - 2. Quit India Movement
 - 3. Second Round Table Conference
 - 4. Khilafat movement

Q.2 Which of the following is an example of a Western coast port?

- Ans**
- 1. Vishakhapatnam port
 - 2. Haldia port
 - 3. Tuticorin port
 - 4. Kandla port

Q.3 Pandit Ram Dayal Sharma was awarded the Padma Shri in 2022 for Nautangi, Swang, Bhagat, _____ and Rasiya forms.

- Ans**
- 1. Rasleela
 - 2. Khorla
 - 3. Matki
 - 4. Phag

Q.4 Who among the following is a famous performer of Kalbelia dance form?

- Ans**
- 1. Vyjayanti Kashi
 - 2. Gulabo Sopera
 - 3. Geeta Mahalik
 - 4. Minati Mishra

Q.5 'The Test of My Life: From Cricket to Cancer and Back', is the autobiography of which famous Indian cricketer?

- Ans**
- 1. Yuvraj Singh
 - 2. Robin Uthappa
 - 3. Akash Chopra
 - 4. Suresh Raina

Q.6 Windfall gains are NOT included while calculating national income as _____.

- Ans**
- 1. there is no productive activity connected with them
 - 2. there is value addition
 - 3. there is no income
 - 4. it has already been included

Q.7 Who wrote the famous autobiography titled 'Becoming'?

- Ans
- 1. Michelle Obama
 - 2. Steffi Graf
 - 3. Johnny Marr
 - 4. Andre Agassi

Q.8 Shovana Narayan is associated with which of these dance forms?

- Ans
- 1. Mohiniyattam
 - 2. Kathak
 - 3. Bharatnatyam
 - 4. Kathakali

Q.9 In which of the following states is the Thousand Pillar temple located, in which thousand pillars are built?

- Ans
- 1. Maharashtra
 - 2. Tamil Nadu
 - 3. Telangana
 - 4. Kerala

Q.10 The aim of 'Poorna Swaraj' was adopted during the 1929 session of the _____ Congress.

- Ans
- 1. Poona
 - 2. Amritsar
 - 3. Lucknow
 - 4. Lahore

Q.11 Which of the following is a Directive Principle of State Policy?

- Ans
- 1. To abide by the Constitution and its ideals
 - 2. To cherish and follow the ideals of national struggle
 - 3. To secure a social order for promotion of welfare of people
 - 4. To strive towards excellence in all spheres of individual and collective activity

Q.12 Nalwari fair is organised in which Indian state?

- Ans
- 1. Himachal Pradesh
 - 2. Haryana
 - 3. Uttar Pradesh
 - 4. Punjab

Q.13 Which of the following statements is correct?

- a) India is the only country in the world that has both tigers and lions.
b) The natural habitat of the Indian lion is the Gir forest in Gujarat. Tigers are found in the forests of Madhya Pradesh, the Sundarbans of West Bengal and the Himalayan region.

- Ans
- 1. Both a and b are incorrect.
 - 2. Both a and b are correct.
 - 3. Only a is correct.
 - 4. Only b is correct.

Q.14 Name the Mauryan king who extended control as far northwest as Afghanistan and Baluchistan.

- Ans
- 1. Chandragupta Maurya
 - 2. Bindusara
 - 3. Dashratha
 - 4. Samprati

Q.15 In which of the following states was the first edition of the Khelo India University Games held in 2020?

- Ans
- 1. Assam
 - 2. Haryana
 - 3. Karnataka
 - 4. Odisha

Q.16 Padma Shri awardee Madhuri Barthwal from _____ is a legendary folk singer. She was the first woman music composer for All India Radio.

- Ans
- 1. Haryana
 - 2. Punjab
 - 3. Uttarakhand
 - 4. Uttar Pradesh

Q.17 Which country did India beat in the Thomas Cup Finals in 2022?

- Ans
- 1. Malaysia
 - 2. Indonesia
 - 3. Singapore
 - 4. Pakistan

Q.18 In ____, as an immediate measure to resolve the balance of payments crisis, the Indian rupee was devalued against foreign currencies.

- Ans
- 1. 1991
 - 2. 1981
 - 3. 1961
 - 4. 1971

Q.19 Which river basin has a catchment area of 5,179 km², which originates from the Belgaum district of Karnataka and falls in Karwar Bay?

- Ans
- 1. Bharathapuzha
 - 2. Palar
 - 3. Kalinadi
 - 4. Brahmani

Q.20 Who among the following social reformers of British India was known as Lokhitwadi?

- Ans
- 1. Veeresalingam Pantulu
 - 2. Jyotiba Phule
 - 3. Gopal Hari Deshmukh
 - 4. Narayan Guru

Q.21 Sonal Mansingh got the Sangeet Natak Akademi Award for which form of dance?

- Ans
- 1. Manipuri
 - 2. Odissi
 - 3. Kuchipudi
 - 4. Mohiniattam

Q.22 How many fundamental duties were enumerated in the 42nd Amendment of the Constitution?

- Ans
- 1. 10
 - 2. 12
 - 3. 8
 - 4. 18

Q.23 State legislature has the concurrent powers enumerated in List _____ of the Seventh Schedule of the Constitution.

- Ans
- 1. IV
 - 2. I
 - 3. III
 - 4. II

Q.24 Which of the following replaced the Planning Commission in 2014?

- Ans
- 1. NITI Aayog
 - 2. SEBI
 - 3. Stand Up India Scheme
 - 4. NABARD

Q.25 Who became the first Indian woman to win an Olympic medal?

- Ans
- 1. Sakshi Malik
 - 2. Karnam Malleswari
 - 3. Saina Nehwal
 - 4. Mary Kom

Q.26 To which country had India offered extensive security co-operation especially after Operation Cactus in 1988?

- Ans
- 1. Maldives
 - 2. Bhutan
 - 3. Nepal
 - 4. Sri Lanka

Q.27 _____ scheme was announced based on the five pillars to overcome difficulties caused due to COVID-19 in India.

- Ans
- 1. Swachh Bharat Abhiyan
 - 2. Ayushman Bharat
 - 3. PM-JAY
 - 4. Atmanirbhar Bharat Abhiyan

Q.28 In which state is coffee a major plantation crop?

- Ans
- 1. Karnataka
 - 2. Assam
 - 3. Madhya Pradesh
 - 4. Haryana

Q.29 Who among the following established the Arya Samaj and in which year?

- Ans
- 1. Swami Dayananda Sarasvati in 1875
 - 2. Swami Vivekananda in 1875
 - 3. Swami Vivekananda in 1785
 - 4. Swami Dayananda Sarasvati in 1785

Q.30 Nadir Shah was the ruler of _____ who sacked and plundered the city of Delhi in 1739.

- Ans
- 1. Iraq
 - 2. Iran
 - 3. Mongolia
 - 4. Turkey

Q.31 Who among the following Vijayanagara rulers founded a suburban township near Vijayanagara called Nagalapur:

- Ans**
- 1. Achyuta Deva Raya
 - 2. Rama Raya
 - 3. Krishna Deva Raya
 - 4. Sadasiva Raya

Q.32 Nanjiyamma received the National Award _____ for the song Kalakkatha Sandana from the Malayalam film Ayyappanum Koshiyum.

- Ans**
- 1. 2021
 - 2. 2020
 - 3. 2019
 - 4. 2018

Q.33 The following are the features of which initiative of the Government of India?

- a. It is devised to transform India into a global design and manufacturing hub.
- b. It has an Investor Facilitation Cell to assist investors in seeking regulatory approvals, hand-holding services through the pre-investment phase, execution and after-care support.
- c. It aspires to facilitate investment, foster innovation, enhance skill development and build best-in-class manufacturing infrastructure.

- Ans**
- 1. Skill India
 - 2. Stand up India
 - 3. Make in India
 - 4. Start-up India

Q.34 Which is the largest brackish water lagoon in Asia that was designated as a 'Ramsar Site' in 1981?

- Ans**
- 1. Chilika lake
 - 2. Tampara lake
 - 3. Loktak lake
 - 4. Harike lake

Q.35 Which of the following Trophies/Cups is related to cricket?

- Ans**
- 1. Santosh Trophy
 - 2. Durand Cup
 - 3. Duleep Trophy
 - 4. Thomas Cup

Q.36 Vacuoles in plant cells can occupy up to what percentage of the cell's volume?

- Ans**
- 1. 40
 - 2. 60
 - 3. 90
 - 4. 20

Q.37 The Chief Justice of India will take prior permission from the _____, while appointing Adhoc Judges.

- Ans**
- 1. Collegium of the Supreme Court
 - 2. Prime Minister of India
 - 3. Parliament
 - 4. President of India

Q.38 Who composed the play 'Mrichchhakatika'?

- Ans**
- 1. Atul
 - 2. Kalidasa
 - 3. Sudraka
 - 4. Bhans

Q.39 Which of the following Articles mentions that the state shall not deny to any person equality before the law or the protection of the laws within the territory of India?

- Ans**
- 1. Article 14
 - 2. Article 15
 - 3. Article 12
 - 4. Article 13

Q.40 Who has the power to grant pardons?

- Ans**
- 1. President
 - 2. Attorney General
 - 3. Chief Justice of India
 - 4. Chief Minister

Q.41 The 'Sinhalese' ethnic group is found in which of the following countries?

- Ans**
- 1. Nepal
 - 2. Sri Lanka
 - 3. Myanmar
 - 4. Indonesia

Q.42 Which of the following elements has the highest atomic number?

- Ans**
- 1. Silver
 - 2. Copper
 - 3. Gold
 - 4. Iron

Q.43 Which natural form of vitamin B helps to prevent some of the major birth defects of the baby's brain (anencephaly) and spina bifida?

- Ans**
- 1. Cobalamin
 - 2. Folate
 - 3. Pantothenic acid
 - 4. Pyridoxine

Q.44 Which body was responsible for formulating, implementing and regulating the five year plans before the year 2015?

- Ans**
- 1. Planning Commission
 - 2. Ministry of Rural Development
 - 3. Reserve Bank of India
 - 4. Ministry of Finance

Q.45 According to the 2011 census, which state has the highest sex ratio?

- Ans**
- 1. Uttar Pradesh
 - 2. Kerala
 - 3. Maharashtra
 - 4. West Bengal

Q.46 The cultural festival of Ratha Saptami is primarily celebrated in which Indian state?

- Ans**
- 1. Andhra Pradesh
 - 2. Himachal Pradesh
 - 3. Bihar
 - 4. West Bengal

Q.47 How many layers of structures consist of the cell envelope?

- Ans
- 1. Three
 - 2. Four
 - 3. One
 - 4. Two

Q.48 What is the purpose of the 'EShakti' programme?

- Ans
- 1. Giving electricity to women farmers
 - 2. Providing loans to buy e-rickshaws
 - 3. Digitisation of Self-Help Group details for banks
 - 4. Providing credit cards for women

Q.49 Which of the following is NOT listed in the Directive Principles of State Policy?

- Ans
- 1. Rights for transgenders in certain cases
 - 2. Promote the welfare of the people
 - 3. Uniform civil code for citizens
 - 4. Equal pay for equal work

Q.50 Bishnupur Group of Temples is located in which Indian state?

- Ans
- 1. Bihar
 - 2. West Bengal
 - 3. Madhya Pradesh
 - 4. Assam

Section : Reasoning

Q.1 Select the figure from the given options that will replace the question mark (?) in the figure given below to complete the pattern so that the final image is symmetrical.

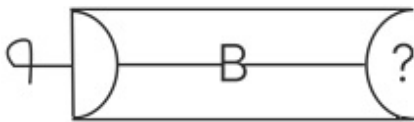

- Ans
- 1.
 - 2.
 - 3.
 - 4.

Q.2 Select the set in which the numbers are related in the same way as are the numbers of the following sets.

(NOTE : Operations should be performed on the whole numbers, without breaking down the numbers into its digits. E.g. 13 – Operations on 13 such as adding /deleting /multiplying etc. to 13 can be performed. Breaking down 13 into 1 and 3 and then performing mathematical operations on 1 and 3 is not allowed.)

(63, 9, 36)
(105, 15, 60)

- Ans
- ✓ 1. (133, 19, 76)
 - ✗ 2. (133, 17, 74)
 - ✗ 3. (129, 19, 74)
 - ✗ 4. (129, 17, 76)

Q.3 Read the given statements and conclusions carefully. Assuming that the information given in the statements is true, even if it appears to be at variance with commonly known facts, decide which of the given conclusions logically follow(s) from the statements.

Statements:

Some balloons are cars.

Some cars are rockets.

Conclusions:

I. Some rockets are balloons.

II. All rockets are balloons.

- Ans
- ✗ 1. Only conclusion I follows
 - ✗ 2. Both conclusions I and II follow
 - ✗ 3. Only conclusion II follows
 - ✓ 4. Neither conclusion I nor II follows

Q.4 Select the correct mirror image of the given figure when the mirror is placed at 'AB' as shown.

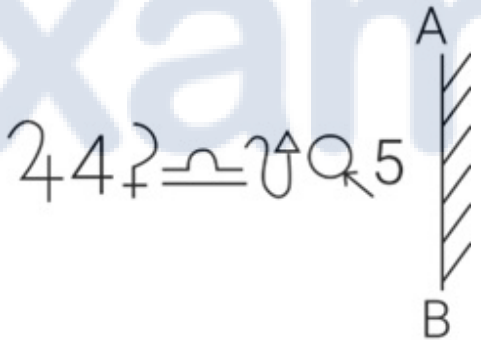

- Ans
- ✗ 1. 5, q, u, f, 4, 2
 - ✗ 2. 2, q, u, f, 4, 5
 - ✗ 3. 2, q, u, f, 4, 5
 - ✓ 4. 2, q, u, f, 4, 5

Q.5 Select the option in which the given figure is embedded (rotation is NOT allowed).



Ans

✓ 1.

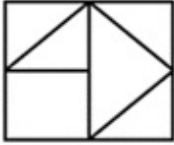

✗ 2.

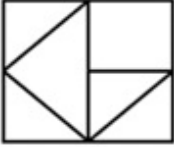

✗ 3.

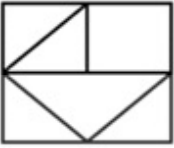

✗ 4.

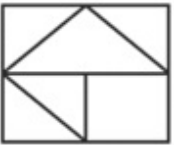

Q.6 Select the option in which the given figure is embedded (rotation is NOT allowed).



Ans

✗ 1.

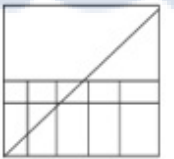

✗ 2.

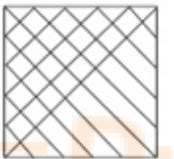

✗ 3.

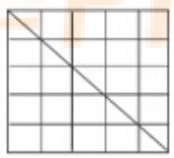

✓ 4.

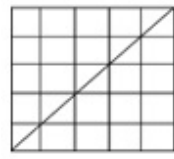

Q.7 Which figure should replace the question mark (?) in the following series to continue the pattern?

☆	9	Z	∩	
∩ R	R ∩	☆ 9	9 ☆	?
Z 9 ☆	Z R	∩ Z	R	

Ans

✗ 1.

☆	
Z ∩	
R 9	

✗ 2.

	R
∩ Z	
☆ 9	

✗ 3.

☆	
Z R	
9 ∩	

✓ 4.

	R
Z ∩	
9 ☆	

Q.8 In a certain code language, 'HAND' is written as '16' and 'ENTRY' is written as '20'. How will 'AIRPORT' be written in that language?

Ans ✗ 1. 22

✗ 2. 26

✗ 3. 24

✓ 4. 28

Prepare 50% Faster

Q.9 A square transparent sheet with a pattern is shown in the given figure. How will the pattern appear when the transparent sheet is folded at the dotted line.

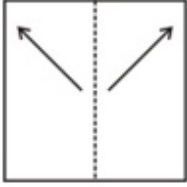

Ans

X 1.

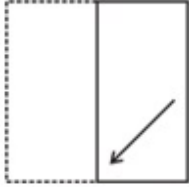

X 2.

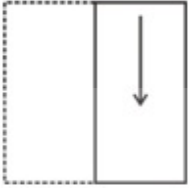

✓ 3.

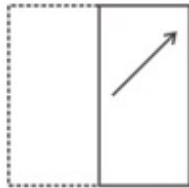

X 4.

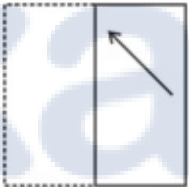

Q.10 6 persons are sitting around a circular table facing the centre, with each person facing another person. Anshu is between Rohin and Sonal. Rohin is opposite to Leena. Fizza is not the immediate neighbour of Rohin. Who is sitting opposite to Prabhleen?

Ans X 1. Fizza

X 2. Leena

✓ 3. Sonal

X 4. Anshu

Q.11 Select the option in which the given figure is embedded (rotation is NOT allowed).

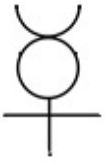

Ans

X 1.



X 2.

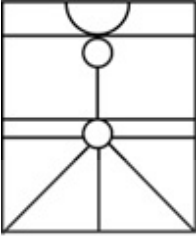

X 3.



✓ 4.

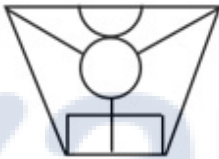

Prepare 50% Faster

Q.12 Which figure should replace the question mark (?) in the following series to continue the pattern?

B	E	U	T	T	U	E	O	U	E	O	T	T	O	E	△	
7	↑	O	B	△	7	7	B	△	U	6	7					?
	△			↑			6			B						

Ans

✓ 1.

O	E	△	T
7	U	6	
	☆		

✗ 2.

T	O	E	△
7	U	6	
	☆		

✗ 3.

O	T	△	E
6	7	B	
	U		

✗ 4.

O	E	△	T
6	7	B	
	U		

Q.13 How many triangles are there in the given figure?

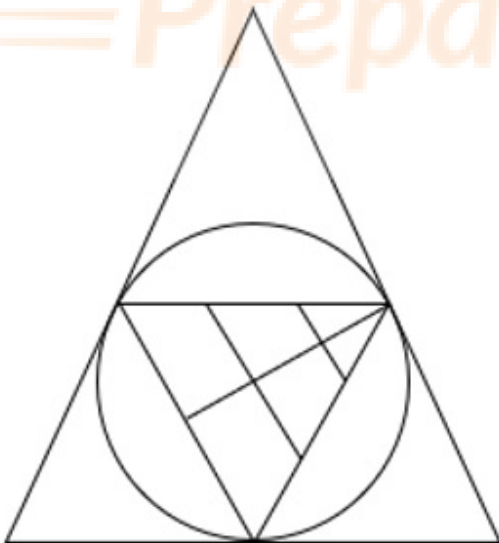

Ans ✓ 1. 13

✗ 2. 11

✗ 3. 12

✗ 4. 14

Q.14 Select the figure from the given options that will replace the question mark (?) in the figure given below to complete the pattern so that the final image is symmetrical.

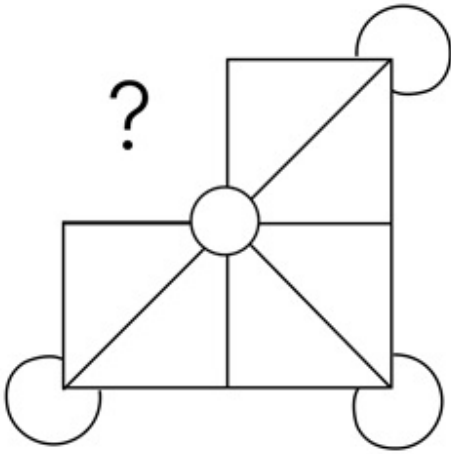

Ans

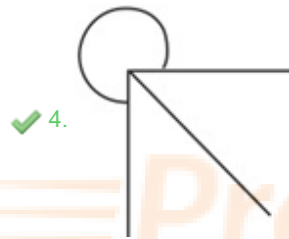
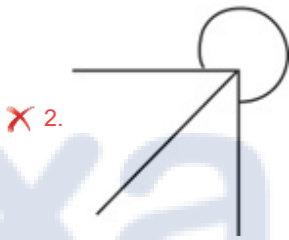
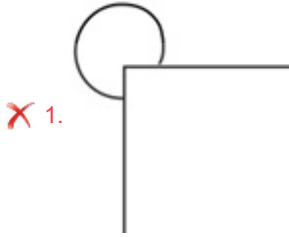

Q.15 Select the option that is related to the third term in the same way as the second term is related to the first term and the sixth term is related to the fifth term.
 $23 : 92 :: 44 : ? :: 32 : 128$

- Ans
- ✗ 1. 204
 - ✗ 2. 172
 - ✓ 3. 176
 - ✗ 4. 160

Q.16 Select the number from the given options that can replace the question mark (?) in the following series.
 3, 6, 12, 24, ?, 96

- Ans
- ✗ 1. 72
 - ✓ 2. 48
 - ✗ 3. 36
 - ✗ 4. 84

Q.17 Which of the following letter clusters will replace the question mark (?) in the given series to make it logically correct?
TVU, QSS, NPQ, KMO, ?

- Ans
- ✓ 1. HJM
 - ✗ 2. IKM
 - ✗ 3. HKL
 - ✗ 4. HKM

Q.18 Which figure should replace the question mark (?) in the following series to continue the pattern?

P	D	E	3	P	I	O	E	P	D	O	I	
3	O		O	D		D	3		3	E		?
	X	I		E	X		X	I		P	X	

Ans

✓ 1.

3	P	O
E	D	
	X	I

✗ 2.

3	I	X
E	D	
	O	P

✗ 3.

E	P	D
X	O	
	E	I

✗ 4.

I	D	O
X	3	
	E	P

Q.19 Select the correct combination of mathematical signs to sequentially replace the * signs and to balance the given equation.
 $8 * 14 * 3 * 24 * 7 = 168$

- Ans
- ✗ 1. +, x, -, +
 - ✗ 2. x, -, x, +
 - ✗ 3. +, x, -, x
 - ✓ 4. x, x, -, x

Q.20 Select a figure from amongst the four given options which, when placed in the blank space of figure (X), would complete the pattern.

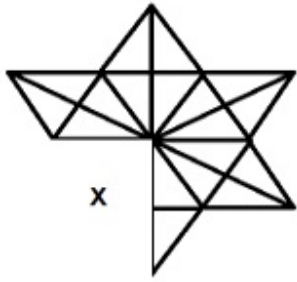

Ans

✓ 1.

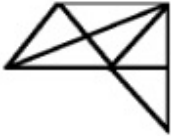

✗ 2.



✗ 3.



✗ 4.

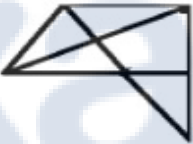

Q.21 Three different positions of the same dice are shown. Find the number on the face opposite the face showing '3'.

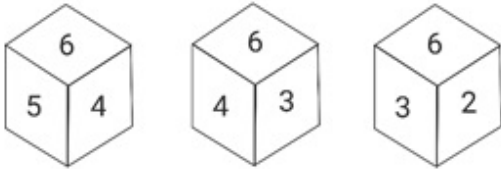

Ans

✗ 1. 4

✗ 2. 1

✓ 3. 5

✗ 4. 6

Q.22 Select the option that is related to the fifth letter cluster in the same way as the second letter cluster is related to the first letter cluster and the fourth letter cluster is related to the third letter cluster.
GBEJ : DGBO :: TJDG : QOAL :: BAHQ : ?

Ans

✗ 1. PLWM

✗ 2. YFRM

✗ 3. OJEH

✓ 4. YFEV

Q.23 If 'A' denotes '+', 'B' denotes 'x', 'C' denotes '-' and 'D' denotes '÷', then what will come in place of '?' in the following equation?
80 C 4 B 5 A 20 = ?

Ans

✗ 1. 40

✓ 2. 80

✗ 3. 20

✗ 4. 120

Q.24 Three different positions of the same dice are shown. Find the number on the face opposite the face showing '3'.

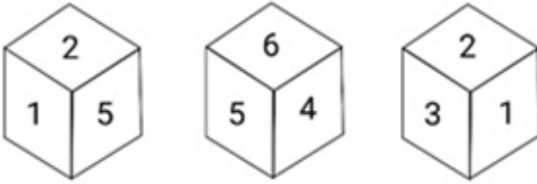

- Ans
- 1. 4
 - 2. 2
 - 3. 1
 - 4. 5

Q.25 Select the option in which the given figure is embedded (rotation is NOT allowed).

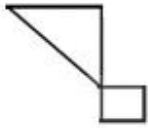

- Ans
- 1.
 - 2.
 - 3.
 - 4.

Section : Numerical Ability

Q.1 The average weight of the first 14 persons among 15 persons is 80 kg. The weight of the 15th person is 42 kg more than the average weight of all 15 persons. Find the weight (in Kg) of the 15th person.

- Ans
- 1. 123
 - 2. 125
 - 3. 127
 - 4. 121

Q.2 Ram and Naresh can complete a work together in 20 days and Naresh and Shyam together in 15 days. All three together can complete the work in 12 days. In how many days can Ram and Shyam together complete the work?

- Ans
- 1. 20
 - 2. 25
 - 3. 26
 - 4. 28

Q.3 A shopkeeper is offering 10% discount on a shirt marked at ₹4,000 and still earns a profit of 20%. What is the cost price (in ₹)?

- Ans
- 1. 3,200
 - 2. 3,600
 - 3. 3,333
 - 4. 3,000

Q.4 Find the area (in square cm) of a right angled triangle whose altitude is 7 cm less than its base and its hypotenuse

- Ans
- 1. 72
 - 2. 60
 - 3. 84
 - 4. 48

Q.5 What is the smallest number which leaves remainder 3 when divided by any of the numbers 5, 8 and 9, but leaves no remainder when it is divided by 11?

- Ans
- 1. 363
 - 2. 563
 - 3. 463
 - 4. 663

Q.6 The largest 4-digit prime number is:

- Ans
- 1. 9967
 - 2. 9983
 - 3. 9973
 - 4. 9991

Q.7 A person has some amount initially. He gives 30% of the amount to his wife. Then from the remaining amount, he gives 20%, 20% and 15%, respectively, to both his sons and one daughter. Now from the amount left, he pays 1/3 of the amount as house rent and the remaining amount of ₹33,600 he deposits in the bank. Find his initial amount.

- Ans
- 1. ₹1,60,000
 - 2. ₹1,40,000
 - 3. ₹1,20,000
 - 4. ₹1,00,000

Q.8 Find the number of ways in which 960 can be written as the product of two numbers that are co-prime to each other.

- Ans
- 1. 6
 - 2. 4
 - 3. 2
 - 4. 8

Q.9 How much should you invest today at 10% compound interest annually to accumulate ₹1,46,410 in 4 years?

- Ans
- 1. ₹1,11,100
 - 2. ₹1,10,000
 - 3. ₹1,00,500
 - 4. ₹1,00,000

Q.10 If $3y = A$ and $6A = 3B$, then $\frac{y}{B}$ is:

- Ans
- 1. $\frac{1}{3}$
 - 2. $\frac{1}{6}$
 - 3. $\frac{1}{5}$
 - 4. $\frac{6}{1}$

Q.11 Deepa deposited ₹10,000 in a bank on simple interest. After 4 years, she received an amount of ₹12,400. Find the interest.

- Ans**
- 1. 6% p.a.
 - 2. 7% p.a.
 - 3. 6.5% p.a.
 - 4. 5.5% p.a.

Q.12 Find the volume (in cm^3) of a cylinder with the diameter of base 8 cm and height 35 cm.

(Take $\pi = \frac{22}{7}$)

- Ans**
- 1. 1731
 - 2. 1760
 - 3. 1780
 - 4. 1792

Q.13 A man takes 40 minutes to cover a certain distance at a speed of 9 km/h. If he walks with a speed of 12 km/h, he covers the same distance in:

- Ans**
- 1. 30 minutes
 - 2. 32 minutes
 - 3. 25 minutes
 - 4. 28 minutes

Q.14 The selling price of 61 items is equal to the cost price of 53 items. What is the profit or loss percentage (rounded off to two decimal places)?

- Ans**
- 1. 13.11% profit
 - 2. 13.11% loss
 - 3. 8.25% loss
 - 4. 8.25% profit

Q.15 Amit received his monthly salary. The ratio of his expenditure to savings is 3 : 2. What percentage of his salary did he spend and what percentage was saved by him, respectively?

- Ans**
- 1. 70% and 30%
 - 2. 55% and 45%
 - 3. 65% and 35%
 - 4. 60% and 40%

Section : Computer Proficiency

Q.1 Which of the following options will allow you to set text within a paragraph at different margins in MS Word 365?

- Ans**
- 1. Page breaks
 - 2. Indenting
 - 3. Border
 - 4. Line spacing

Q.2 Which layer of the internet architecture model is responsible for routing packets between networks?

- Ans**
- 1. Transport layer
 - 2. Network layer
 - 3. Data link layer
 - 4. Application layer

Q.3 In MS word 365 To change the formatting of the text to match the formatting of other text in a document, which of following tools can be used?

- Ans**
- 1. Paragraph alignment
 - 2. SmartArt
 - 3. Format painter
 - 4. Change styles

Q.4 Which of the following is the correct option to draw a line through the middle of text in MS Word 365?

- Ans**
- 1. Line
 - 2. Strikethrough
 - 3. Dash
 - 4. Underline

Q.5 In MS Excel 365 which of the following keyboard shortcuts is used to save a workbook in MS-Excel?

- Ans**
- 1. Ctrl + Shift + S
 - 2. Shift + S
 - 3. Ctrl + S
 - 4. Ctrl + Alt + S

Q.6 In Microsoft Word 2019, which option is common in both the 'Indents & Spacing' and 'Line & Page Breaks' tabs of the 'Paragraph' dialog box?

- Ans**
- 1. General
 - 2. Preview
 - 3. Indentation
 - 4. Textbox options

Q.7 In MS Excel 2007, which option is used for opening a new or existing spreadsheet?

- Ans**
- 1. Office button
 - 2. Format
 - 3. Insert
 - 4. Home

Q.8 Which of the following best describes the difference between Save and Save As?

- Ans**
- 1. 'Save' is used to save file in compressed manner, while 'Save As' is used to save it as it is.
 - 2. 'Save' is used to save file in a local computer, while 'Save As' is used to save it on cloud.
 - 3. 'Save' is used to save file as read only file, while 'Save As' is used to save it as editable file.
 - 4. 'Save' is used to save the document for the first time, while 'Save As' is used to save the document with a new name or different file format.

Q.9 In MS Excel 365, when you right-click on a cell and select 'Filter,' which of the following options is NOT visible?

- Ans**
- 1. Filter by selected cell font
 - 2. Filter by selected cell colour
 - 3. Filter by selected cell height
 - 4. Filter by selected cell values

Q.10 When replying to an email, what is the key difference between 'Reply' and 'Reply all'?

- Ans**
- 1. 'Reply' allows you to edit the original email's content before sending the response, while 'Reply all' automatically includes the entire original email's content in the response.
 - 2. 'Reply' forwards email to specific contacts, while 'Reply all' forwards the original email to all contacts in the address book.
 - 3. 'Reply' sends the response only to the original sender, while 'Reply all' sends the response to all recipients of the original email.
 - 4. 'Reply' attaches any files from the original email, while 'Reply all' includes any attachments along with the entire original content in response.

Constable Executive Male and Female in Delhi Police Examination 2023

Exam Date	20/11/2023
Exam Time	9:00 AM - 10:30 AM
Subject	Constable Executive Male and Female in Delhi Police Examination 2023

Section : General Knowledge

Q.1 Which of the following was the last Five-Year Plan in India before its replacement with NITI Aayog?

- Ans**
- 1. 12th Five-Year Plan 2012-2017
 - 2. 10th Five-Year Plan 2007-2012
 - 3. 11th Five-Year Plan 2007-2012
 - 4. 9th Five-Year Plan 2007-2012

Q.2 Who can give the order and directives to the government for the enforcement of fundamental rights?

- Ans**
- 1. Supreme Court and High Court
 - 2. Governor
 - 3. Prime Minister of India
 - 4. President of India

Q.3 How many seats are reserved for scheduled castes in Lok Sabha?

- Ans**
- 1. 85
 - 2. 86
 - 3. 82
 - 4. 84

Q.4 The 'Make in India' programme, which started in 2014, is similar to _____ of the 1970s and 1980s in India.

- Ans**
- 1. Import substitution policy
 - 2. Export-oriented industrial development
 - 3. License permit raj
 - 4. Free trade policy

Q.5 In which of the following years was the peasant movement in Kheda led by Mahatma Gandhi?

- Ans**
- 1. 1918
 - 2. 1922
 - 3. 1909
 - 4. 1912

Q.6 The atomic number of oxygen is _____.

- Ans**
- 1. 16
 - 2. 14
 - 3. 7
 - 4. 8

Q.7 _____ accounts for the difference between the concept of market price and factor cost in national income measu

- Ans
- 1. Direct taxes
 - 2. Subsidies
 - 3. Net indirect taxes
 - 4. Indirect taxes

Q.8 **Rajaraja I, who assumed power in 985 CE and was known as one of the most powerful kings in South India, belonged to the _____ dynasty.**

- Ans
- 1. Pallava
 - 2. Pandya
 - 3. Chalukaya
 - 4. Chola

Q.9 **President Sukarno of _____ was the Guest of Honour during India's first Republic Day event in 1950.**

- Ans
- 1. Indonesia
 - 2. Maldives
 - 3. Singapore
 - 4. Malaysia

Q.10 **Under 'Atal Beemit Vyakti Kalyan Yojana', up to how much per cent of average wages is provided as payment relief which is payable up to maximum 90 days of unemployment?**

- Ans
- 1. 50%
 - 2. 30%
 - 3. 33%
 - 4. 25%

Q.11 **In food processing, which miscellaneous constituent obtained from the maize plant is mixed with water or juice and boiled to form fillings and give products a glossy semi-clear finish?**

- Ans
- 1. Cornstarch
 - 2. Algin
 - 3. Acacia
 - 4. Gelatin

Q.12 **Who is the author of the work 'Kadambari'?**

- Ans
- 1. Bhans
 - 2. Vilhad
 - 3. Banabhata
 - 4. Aryabhata

Q.13 **The Joint Sitting of the Lok Sabha and Rajya Sabha need a _____ quorum of the Indian Parliament.**

- Ans
- 1. 15%
 - 2. 5%
 - 3. 10%
 - 4. 20%

Q.14 **Nadaswaran instrument is played by _____ .**

- Ans
- 1. Sheikh Chinna Moula
 - 2. Totaram Sarma
 - 3. KV Prasad
 - 4. Panalal Ghosh

Q.15 Which of the following is a push factor of globalisation of business?

- Ans
- 1. Availability of cheap labour in the host country
 - 2. Higher rates of return in host economies
 - 3. Saturation of domestic market
 - 4. Availability of cheap raw material in the host country

Q.16 Which of the following years is related to the SARFAESI Act?

- Ans
- 1. 2004
 - 2. 2002
 - 3. 2000
 - 4. 1999

Q.17 Which mineral composed of silicon and oxygen with chemical composition of SiO_2 is mainly used in glass making, abrasive, foundry sand, hydraulic fracturing proppant, gemstone?

- Ans
- 1. Augite
 - 2. Olivine
 - 3. Quartz
 - 4. Muscovite

Q.18 Manipuri dance often depicts scenes from the life of which of the following Hindu Gods or Goddess?

- Ans
- 1. Lord Krishna
 - 2. Lord Hanuman
 - 3. Goddess Durga
 - 4. Lord Ram

Q.19 Who among the following founded an organisation called the Indian Association, in 1876, along with Surendranath Banerjee?

- Ans
- 1. Jatindranath Mukherjee
 - 2. Benoy Krishna Bose
 - 3. Chittaranjan Das
 - 4. Ananda Mohan Bose

Q.20 The _____ Rebellion in central India broke out in 1910.

- Ans
- 1. Pabna
 - 2. Bastar
 - 3. Warli
 - 4. Kol

Q.21 Padma Shri awardee Pratibha Pahlad is an exponent of which of the following dance forms?

- Ans
- 1. Kuchipudi
 - 2. Odissi
 - 3. Kathak
 - 4. Bharatanatyam

Q.22 Which of the following does NOT play a crucial role in shaping Indian monsoons?

- Ans
- 1. Tibetan Plateau
 - 2. Intertropical Convergence Zone (ITCZ)
 - 3. Western Disturbances
 - 4. Jet Stream

Q.23 After independence, the 1st national games were hosted by which of the following cities?

- Ans**
- 1. Lucknow
 - 2. Kolkata
 - 3. Delhi
 - 4. Bombay

Q.24 Consider the following factors.

- a) Extreme climatic conditions in the Himalayas and the Indian Thar Desert.
- b) Lack of medical facilities in rural areas.
- c) Availability of employment in metro cities.
- d) Poverty in rural India.
- e) Education facilities in urban areas.

Which of the given factors are NOT pull factor(s) for migration in India?

- Ans**
- 1. Only a, b and d
 - 2. Only b and d
 - 3. Only c and e
 - 4. All except d

Q.25 Which of the following Articles of the Constitution of India mentions about the extent of the executive powers of a state?

- Ans**
- 1. Article 165
 - 2. Article 177
 - 3. Article 162
 - 4. Article 168

Q.26 Junagadh Rock Inscription belongs to whom among the following rulers?

- Ans**
- 1. Satakarni I
 - 2. Rudradaman I
 - 3. Kanishka
 - 4. Bindusara

Q.27 The 'Rashtriya Swayamsevak Sangh' was founded in which of the following districts of Maharashtra?

- Ans**
- 1. Nagpur
 - 2. Ahmednagar
 - 3. Amravati
 - 4. Pune

Q.28 The Ajanta Caves are located on the left bank of which of the following rivers?

- Ans**
- 1. Krishna
 - 2. Mahanadi
 - 3. Waghora
 - 4. Tungabhadra

Q.29 Which State won the 11th Junior National Men's Hockey Championship?

- Ans**
- 1. Uttar Pradesh
 - 2. Rajasthan
 - 3. Madhya Pradesh
 - 4. Haryana

Q.30 Which Article of the Indian Constitution mentions that the laws inconsistent with or in derogation of the fundame will be void?

- Ans
- 1. Article 13
 - 2. Article15
 - 3. Article14
 - 4. Article16

Q.31 The method of Election of the President of the India in the Constitution was taken from the Constitution of _____.

- Ans
- 1. South Africa
 - 2. the Unites States of America
 - 3. Canada
 - 4. Ireland

Q.32 Kalyani Kutti Amma received the Sangeet Natak Akademi Award for which form of dance?

- Ans
- 1. Mohiniattam
 - 2. Kathak
 - 3. Kuchipudi
 - 4. Kathakali

Q.33 Madan Singh Chauhan, also known as 'Guruji', is a folk and Sufi singer from _____.

- Ans
- 1. Uttarakhand
 - 2. Haryana
 - 3. Jharkhand
 - 4. Chhattisgarh

Q.34 Which of the following taxes was related to the land revenue (tax on agricultural land) system of the Delhi sultanate?

- Ans
- 1. Jizya
 - 2. Kharaj
 - 3. Zakat
 - 4. Khams

Q.35 When government wants to increase the money supply, it:

- Ans
- 1. sells government bonds
 - 2. increases the Cash Reserve Ratio
 - 3. purchases government bonds
 - 4. increases the Statutory Liquidity Ratio

Q.36 In which state of Myanmar do the Rohingyas primarily reside?

- Ans
- 1. Kayah
 - 2. Shan
 - 3. Chin
 - 4. Rakhine

Q.37 Non-stick pans are coated with _____.

- Ans
- 1. polytetrabromoethylene
 - 2. polytetrachloroethylene
 - 3. polytetrafluoroethylene
 - 4. polytetrafluoromethylene

Q.38 The term 'village panchayats' is mentioned in which of the following Articles of the Constitution of India?

- Ans**
- 1. Article 51
 - 2. Article 49
 - 3. Article 47
 - 4. Article 40

Q.39 Which of the following Union territories has the lowest population density according to the 2011 census?

- Ans**
- 1. Andaman and Nicobar Islands
 - 2. Daman and Diu
 - 3. Delhi
 - 4. Puducherry

Q.40 The English novel 'Little Women' was written by which of the following authors?

- Ans**
- 1. George Eliot
 - 2. Anthony Trollope
 - 3. Louisa May Alcott
 - 4. Herman Melville

Q.41 Wangala is a popular harvest festival of which Indian state?

- Ans**
- 1. West Bengal
 - 2. Uttar Pradesh
 - 3. Meghalaya
 - 4. Bihar

Q.42 The length of a tennis court is _____ .

- Ans**
- 1. 80 ft
 - 2. 70 ft
 - 3. 78 ft
 - 4. 73 ft

Q.43 Which of the following is an INCORRECT statement related to dental health?

- Ans**
- 1. Toothpaste, which is generally acidic, prevents tooth decay.
 - 2. Tooth enamel, made up of calcium hydroxyapatite is the hardest substance in the body.
 - 3. Tooth decay starts when the pH of the mouth is lower than 5.5.
 - 4. Bacteria present in the mouth produce acids by degradation of sugar and food particles remaining in the mouth after eating.

Q.44 The Bokaro Steel Plant is located in:

- Ans**
- 1. Maharashtra
 - 2. Chhattisgarh
 - 3. Jharkhand
 - 4. Rajasthan

Q.45 Raja Reddy is associated with which of the following dance forms?

- Ans**
- 1. Kathak
 - 2. Bharatanatyam
 - 3. Kathakali
 - 4. Kuchipudi

Q.46 " _____ is the writer of the book 'India Wins Freedom'."

- Ans
- 1. Jawahar Lal Nehru
 - 2. Maulana Abul Kalam Azad
 - 3. APJ Abdul Kalam
 - 4. Mahatma Gandhi

Q.47 Pillared Verandah and cells are integral parts of which of the following Buddhist structures?

- Ans
- 1. Ajanta Caves
 - 2. Sanchi Stupa
 - 3. Tawang Monastery
 - 4. Bodhgaya Temple

Q.48 Suryakumar Yadav is associated with which of the following games?

- Ans
- 1. Wrestling
 - 2. Boxing
 - 3. Cricket
 - 4. Football

Q.49 The Siberian Shelf, one of the coastal shelves of the Arctic Ocean, is the largest continental shelf on Earth. How many kilometres does it extend offshore?

- Ans
- 1. 910 km
 - 2. 1,700 km
 - 3. 1,500 km
 - 4. 600 km

Q.50 The level of urbanisation in India is measured in terms of _____ of urban population to total population.

- Ans
- 1. fraction
 - 2. ratio
 - 3. percentage
 - 4. decimal

Section : Reasoning

Prepare 50% Faster

Q.1 Which figure should replace the question mark (?) if the following series were to be continued?

Z	E	E	8	8	V	V	=	=	E	
	8		Z		=		8		↑	?
V	∩	∩	V	E	∩	∩	E	V	∩	

Ans

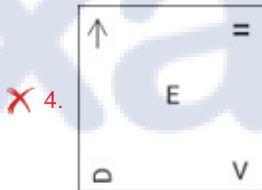
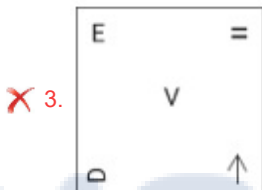
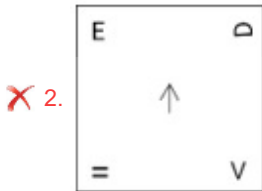
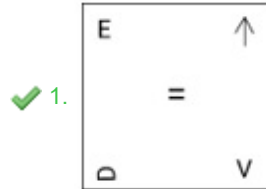

Q.2 Which of the following options will replace the question mark (?) in the given series?
109, 101, 93, 85, 77, ?

- Ans
- ✗ 1. 52
 - ✗ 2. 61
 - ✓ 3. 69
 - ✗ 4. 58

Q.3 Select the option that is related to the third term in the same way as the second term is related to the first term and the sixth term is related to the fifth term.

4 : 125 :: 9 : ? :: 11 : 1728

- Ans
- ✓ 1. 1000
 - ✗ 2. 512
 - ✗ 3. 999
 - ✗ 4. 729

Q.4 Select the option in which the given figure is embedded (rotation is NOT allowed).



Ans

✓ 1.

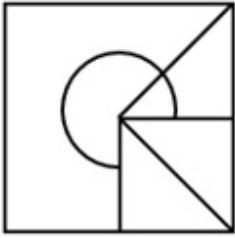

✗ 2.



✗ 3.



✗ 4.

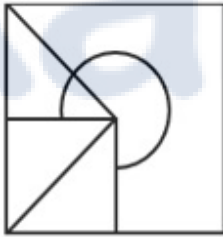

Prepare 50% Faster

Q.5

Select the option figure that will replace the question mark (?) in the figure given below to complete the pattern.

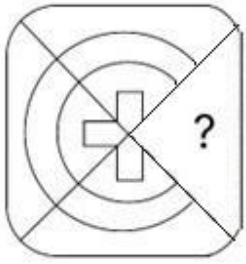

Ans

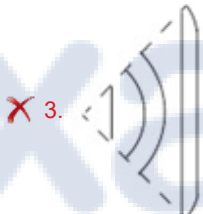
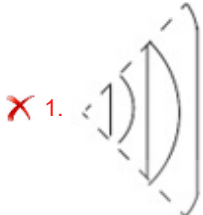

Prepare 50% Faster

Q.6 A square sheet of paper is folded along the dotted line successively along the directions shown and is then punched last. How would the paper look when unfolded?

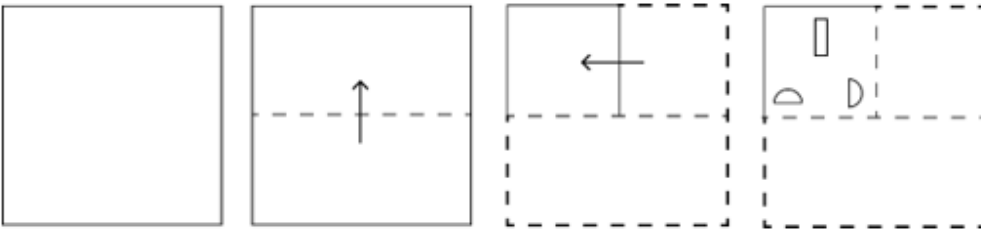

Ans

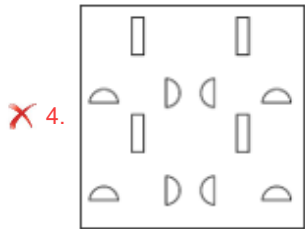
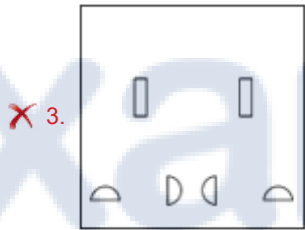
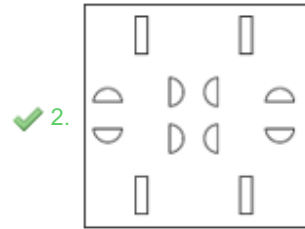
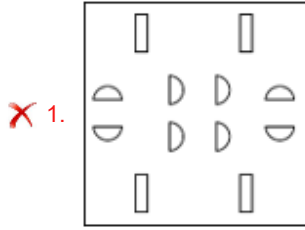

Prepare 50% Faster

Q.7 Select the figure from the options that can replace the question mark (?) and complete the given pattern.

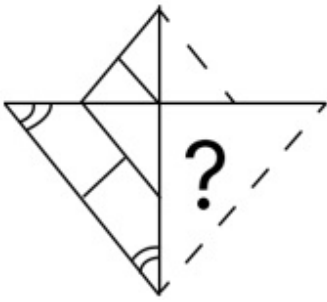

Ans

1.

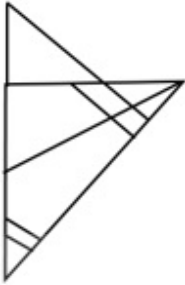

2.

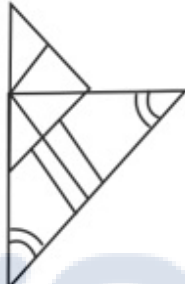

3.

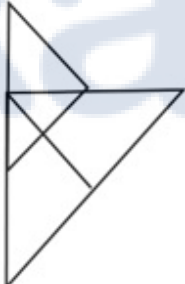

4.

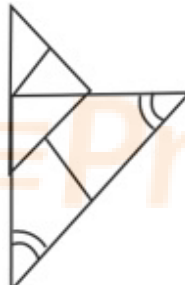

Q.8 Select the set in which the numbers are related in the same way as are the numbers of the following sets.

(NOTE: Operations should be performed on the whole numbers, without breaking down the numbers into its constituent digits. E.g. 13 – Operations on 13 such as adding/deleting/multiplying etc. to 13 can be performed. Breaking down 13 into 1 and 3 and then performing mathematical operations on 1 and 3 is not allowed)
(16, 40, 5), (3, 27, 18)

Ans 1. (9, 35, 6)

2. (7, 26, 8)

3. (9, 27, 6)

4. (8, 29, 7)

Q.9 Which figure should replace the question mark (?) in the following series to continue the pattern?

D O U X	T A O 3	X T 3 D	U A T R	?
3 A R T	X R U D	R A O U	D O 3 X	

Ans

✗ 1.

D O A U
X 3 T R

✗ 2.

A O 3 T
U D X R

✓ 3.

D U R X
O A T 3

✗ 4.

R U A T
X D O 3

Q.10 How many triangles are there in the given figure?

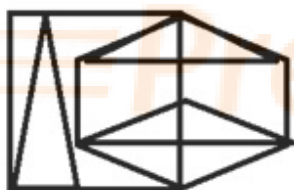

Ans ✗ 1. 10

✓ 2. 13

✗ 3. 11

✗ 4. 12

Q.11 Select the word-pair that best represents a similar relationship to the one expressed in the pair of words given below. (The words must be considered as meaningful English words and must not be related to each other based on the number of letters/number of consonants/vowels in the word.)

Clarify : Explain

Ans ✗ 1. Blow : Air

✓ 2. Raise : Lift

✗ 3. Mother : Home

✗ 4. Boring : Exciting

Q.12 Select the figure from the given options that will replace the question mark (?) in the figure given below to complete the pattern.

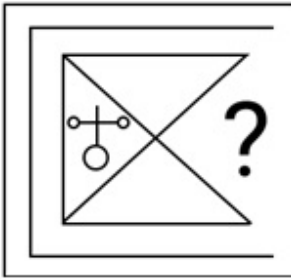

Ans

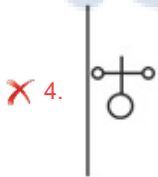
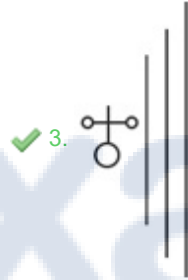
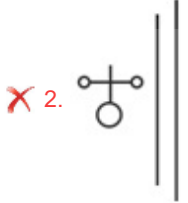
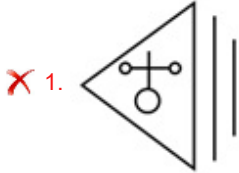

Q.13 Select the correct combination of mathematical signs that can sequentially replace the * signs and balance the given expression.

$$23 * 9 * 13 * 96 * 2 * 92$$

Ans ✓ 1. +, ×, -, ÷, =

✗ 2. +, -, ×, ÷, =

✗ 3. ÷, +, ×, -, =

✗ 4. ×, +, -, ÷, =

Q.14 A paper is folded and cut as shown below. How will it appear when unfolded?

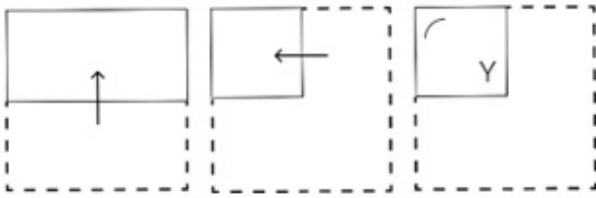

Ans

✗ 1.

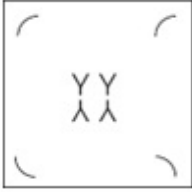

✓ 2.

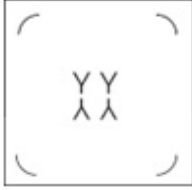

✗ 3.



✗ 4.

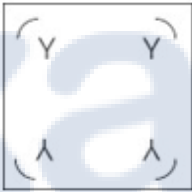

Prepare 50% Faster

Q.15 Select the figure from the options that can replace the question mark (?) and complete the given pattern.

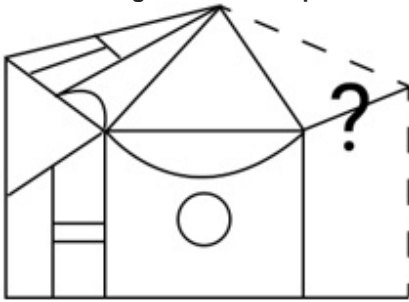

Ans

X 1.

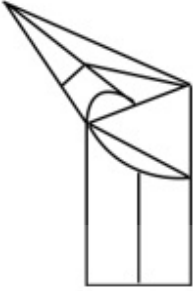

X 2.



✓ 3.

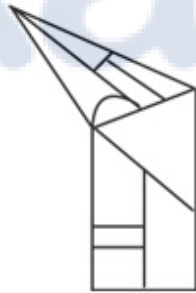

X 4.

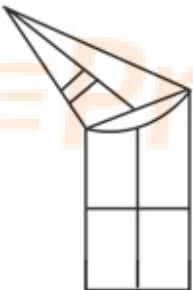

Q.16 Which figure should replace the question mark (?) in the following series to continue the pattern?

G	V	☆	9	
△ ☆	☆ ↑	↑ V	V 3	?
↑	△	3	↑	

Ans

✗ 1.

↑		
	3	V
		9

✗ 2.

3		
	9	V
		□

✓ 3.

V		
	3	9
		□

✗ 4.

↑		
	9	□
		V

Q.17 Two statements are given, followed by two conclusions numbered I and II. Assuming the statements to be true, even if they seem to be at variance with commonly known facts, decide which of the conclusions logically follow(s) from the statements.
Statements:
 All computers are machines.
 Some computers are robots.
Conclusions:
 I. All robots are computers.
 II. Some machines are robots.

Ans ✓ 1. Only Conclusion II follows.

✗ 2. Only Conclusion I follows.

✗ 3. Neither Conclusion I nor II follows.

✗ 4. Both Conclusions I and II follow.

Q.18 Which of the following terms will replace the question mark (?) in the given series?
 WIP, ULN, SOL, ?, OUH

Ans ✗ 1. RSJ

✓ 2. QRJ

✗ 3. RRK

✗ 4. QSK

Q.19 Which two signs should be interchanged to make the given equation correct?
 $87 + 85 - 25 \times 3 \div 291 = 3$

- Ans
- 1. \div and $+$
 - 2. $+$ and $-$
 - 3. $-$ and \times
 - 4. $=$ and \div

Q.20 Select the correct mirror image of the given figure when the mirror is placed at PQ as shown below.



- Ans
- 1. ^\$@#FFAERG
 - 2. ^\$@#FFAREG
 - 3. ^\$@#FFAERG
 - 4. ^\$@#FFAERG

Q.21 A, B, C, D, E, F and G were sitting in a straight row, facing north. G was second to the left of A. Only C was to the right of F. A was exactly between B and D. E was to the immediate left of F. Who among the following was at the extreme left end of the row?

- Ans
- 1. E
 - 2. B
 - 3. G
 - 4. D

Prepare 50% Faster

Q.22 Which of the following option figures will complete the pattern in the figure given below?



Ans



Q.23 In a certain code language, 'FOOD' is coded as 'HMQB' and 'EDGE' is coded as 'GBIC'. How will 'MEAT' be coded in the same language?

Ans

✗ 1. PDCR

✗ 2. OCDS

✓ 3. OCCR

✗ 4. PCCR

Prepare 50% Faster

Q.24 A square sheet of paper is folded along the dotted line successively along the directions shown and is then punched last. How would the paper look when unfolded?

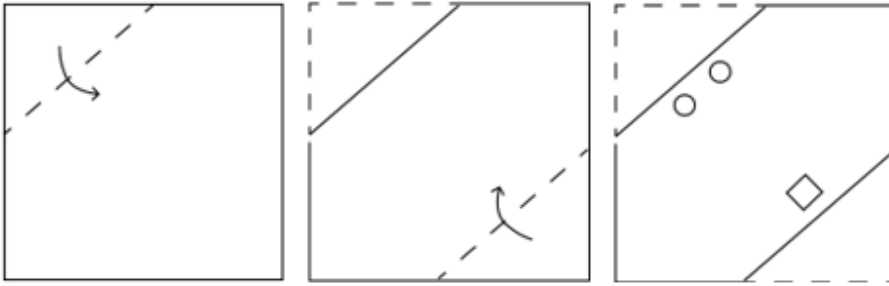

Ans

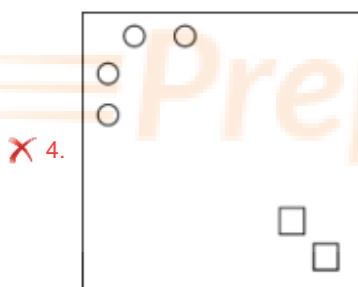
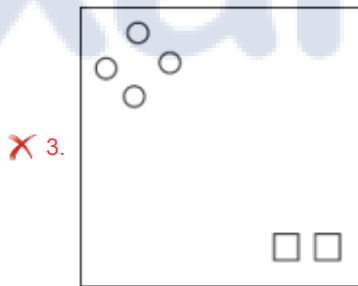
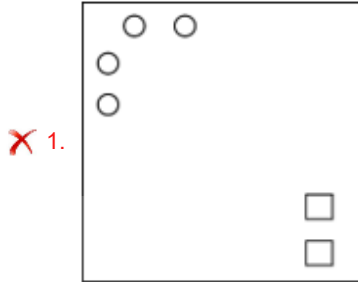

Q.25 Six letters, L, M, N, O, P and Q are written on different faces of a dice. Three positions of this dice are shown here. Find the letter on the face opposite M.



- Ans
- ✗ 1. O
 - ✗ 2. Q
 - ✗ 3. L
 - ✓ 4. P

Q.1 The sum of five consecutive integers is 235. Which of the five integers is prime?

- Ans
- 1. 51
 - 2. 43
 - 3. 53
 - 4. 47

Q.2 A sum of ₹32,760 was taken as a loan. This is to be paid in three equal annual instalments. If the rate of interest is 20% compounded annually, then the value of each instalment is:

- Ans
- 1. ₹10,000
 - 2. ₹11,000
 - 3. ₹16,552
 - 4. ₹15,552

Q.3 The cost price of an item is one-fourth of its selling price. What is the gain or loss percentage on that item?

- Ans
- 1. Gain of 100%
 - 2. Gain of 300%
 - 3. Loss of 100%
 - 4. Loss of 300%

Q.4 Which of the following numbers is NOT a prime number?

- Ans
- 1. 1271
 - 2. 1171
 - 3. 1471
 - 4. 1571

Q.5 If the breadth of the rectangle is decreased by 40% and its length is increased by 25%, find the percentage change in its area.

- Ans
- 1. 75% decrease
 - 2. 25% decrease
 - 3. 90% decrease
 - 4. 5% increase

Q.6 If 27 identical small spheres are made out of a big sphere of diameter 6 cm, what is the radius (in cm) of the small sphere?

- Ans
- 1. 1.5
 - 2. 1
 - 3. 2
 - 4. 0.5

Q.7 A device is available for ₹8,000 cash or ₹500 down payment followed by four equal monthly instalments. If the rate of simple interest charged is 25% per annum, then find the instalment, to the nearest rupee.

- Ans
- 1. ₹1,977
 - 2. ₹1,790
 - 3. ₹1,970
 - 4. ₹1,987

Q.8 A bus is moving at a speed of $40 \frac{\text{km}}{\text{h}}$ and is ahead of a car, which is moving at a speed of $75 \frac{\text{km}}{\text{h}}$. What is the distance (in km) between the bus and the car, if it takes 15 minutes for the car to catch up with the bus?

- Ans
- 1. 9.12
 - 2. 8.75
 - 3. 8.54
 - 4. 5.87

Q.9 The internal radius of a metallic pipe is 2 cm and its external radius is 2.7 cm. If the length of the pipe is 10 cm, then find the volume of the metal used for this pipe. (Use $\pi = \frac{22}{7}$)

- Ans
- 1. 110.5 cm^3
 - 2. 103.4 cm^3
 - 3. 93.4 cm^3
 - 4. 101.2 cm^3

Q.10 Simplify the following.

$$2 - \frac{1}{5 + \frac{1}{6 - \frac{2}{5}}}$$

- Ans
- 1. $\frac{262}{145}$
 - 2. $\frac{145}{262}$
 - 3. $\frac{51}{28}$
 - 4. $\frac{165}{325}$

Q.11 The average marks of three classes of 50, 65 and 45 students, respectively, are 75, 80 and 90. Find the average marks of all the students.

- Ans
- 1. 75.81
 - 2. 91.65
 - 3. 71.65
 - 4. 81.25

Q.12 The ratio of the number of boys to that of the girls in a school is 5 : 7. If there are 1148 girls in the school, how many boys are there in that school?

- Ans
- 1. 810
 - 2. 830
 - 3. 840
 - 4. 820

Q.13 A camp has provisions for 60 persons for 18 days. In how many days will the same provisions finish off if the strength of the camp is increased to 90 persons?

- Ans**
- 1. 8 days
 - 2. 12 days
 - 3. 15 days
 - 4. 18 days

Q.14 When 24 is subtracted from a number, it reduces to 60%. The two-fifth of that number is:

- Ans**
- 1. 36
 - 2. 24
 - 3. 60
 - 4. 48

Q.15 A machine was offered a 16% trade discount on the marked price of ₹30,000. After some cash discount, the machine was sold for ₹23,184. The cash discount is:

- Ans**
- 1. 10%
 - 2. 9%
 - 3. 6%
 - 4. 8%

Section : Computer Proficiency

Q.1 Which social networking platform is known for its character limit on posts and real-time updates?

- Ans**
- 1. LinkedIn
 - 2. Facebook
 - 3. Twitter
 - 4. Instagram

Q.2 When editing data in an MS Excel 365 worksheet, which of the following actions will allow you to reverse your recent changes?

- Ans**
- 1. Copy
 - 2. Paste
 - 3. Save
 - 4. Undo

Q.3 In Microsoft Word 2019, which of the following settings is NOT found in the 'Indents and Spacing' tab of the 'Paragraph' dialog box?

- Ans**
- 1. Indentation
 - 2. Pagination
 - 3. Spacing
 - 4. General

Q.4 Which of the following components is responsible for translating domain names (e.g., www.example.com) into IP addresses (e.g. 192.168.1.1) to enable communication over the internet?

- Ans**
- 1. DNS Server
 - 2. Firewall
 - 3. Modem
 - 4. Router

Q.5 In MS Excel 365, What is the main purpose of using a chart in MS Excel?

- Ans
- 1. To store data
 - 2. To format text
 - 3. To visually represent data
 - 4. To perform calculations

Q.6 Which of the following shortcut keys is used to get context sensitive Help in MS Word 365?

- Ans
- 1. Press F6
 - 2. Press F10
 - 3. Press F1
 - 4. Press F7

Q.7 What is the category of software that enables word processing, database management, graphic manipulation and spreadsheet creation?

- Ans
- 1. Structure
 - 2. Application
 - 3. Framework
 - 4. System

Q.8 Which of the following keyboard shortcut keys is used to pick a new font for the selected text in MS-Word 365?

- Ans
- 1. Ctrl + F
 - 2. Ctrl + Shift + F
 - 3. Shift + F
 - 4. Ctrl + Alt + F

Q.9 Which keyboard shortcut allows you to edit the content of a selected cell directly in the cell itself in Microsoft Excel 365?

- Ans
- 1. Ctrl + E
 - 2. Ctrl + C
 - 3. F12
 - 4. F2

Q.10 What is the shortcut command in MS-Word 365 for selecting all the words from the file?

- Ans
- 1. Ctrl + A
 - 2. Ctrl + C
 - 3. Ctrl + X
 - 4. Ctrl + Z

Constable Executive Male and Female in Delhi Police Examination 2023

Exam Date	20/11/2023
Exam Time	12:00 PM - 1:30 PM
Subject	Constable Executive Male and Female in Delhi Police Examination 2023

Section : General Knowledge

Q.1 Which physicist is known for extensive research in 'radiation phenomena' and the discovery of polonium and radium?

- Ans**
- 1. Rosalind Franklin
 - 2. Marie Curie
 - 3. Helen Quinn
 - 4. Lise Meitner

Q.2 Which of the following statements is correct with respect to basketball?

- Ans**
- 1. Each team is made up of 12 players, with only 5 allowed on the court at any time.
 - 2. Each team is made up of 12 players, with only 8 allowed on the court at any time.
 - 3. Each team is made up of 11 players, with only 7 allowed on the court at any time.
 - 4. Each team is made up of 11 players, with only 4 allowed on the court at any time.

Q.3 Which method was used for making bronze statues during Harrapan Civilisation?

- Ans**
- 1. Ivory carving
 - 2. Wood carving
 - 3. Lost wax casting
 - 4. Stone carving

Q.4 During the British era Indian economy was known as _____.

- Ans**
- 1. a source for its raw material
 - 2. only a market for agricultural products
 - 3. a developed economy
 - 4. a source for finished capital goods

Q.5 Who inaugurated the 36th National Games, which were held in the year 2022?

- Ans**
- 1. Nisith Pramanik
 - 2. Narendra Modi
 - 3. Anurag Thakur
 - 4. Kiren Rijju

Q.6 Which of the following writs is issued by a superior court to compel a lower court or a government officer to perform mandatory or purely ministerial duties correctly?

- Ans**
- 1. Habeas Corpus
 - 2. Quo warranto
 - 3. Mandamus
 - 4. Certiorari

Q.7 According to Mughal records, during Akbar's reign, there were 29 Mansabdars with a rank of _____.

- Ans
- 1. 5,000 zat
 - 2. 500 zat
 - 3. 7,000 zat
 - 4. 2,500 zat

Q.8 Which of the following was adopted as the 'National Emblem' on 26 January 1950?

- Ans
- 1. Single lion capital at Rampurva
 - 2. Single bull capital at Rampurva
 - 3. Single lion capital at Lauriya Nandangarh
 - 4. Lion capital of Sarnath

Q.9 Padma Bhushan awardee Kumari Kamala is an exponent of _____.

- Ans
- 1. Mohiniyattam
 - 2. Sattriya
 - 3. Odissi
 - 4. Bharatanatyam

Q.10 Which of the following is the highest peak of Western Ghats?

- Ans
- 1. Mahendra Giri
 - 2. Doda Betta
 - 3. Anai Mudi
 - 4. Javedi Hills

Q.11 The Contingency Fund of India is operated by the _____.

- Ans
- 1. Speaker
 - 2. Prime Minister
 - 3. Finance Minister
 - 4. President

Q.12 The value of final goods and services produced in a country is known as _____.

- Ans
- 1. distribution of income
 - 2. national productivity
 - 3. national income
 - 4. per capita income

Q.13 प्रारंभिक वैदिक समाज में, परिवार के मुखिया को किस नाम से जाना जाता था?

- Ans
- 1. पुरोहित
 - 2. कुलपा
 - 3. ग्रामणी
 - 4. व्रजपति

Q.14 Pandit S Balleh Bhajantri is a _____ artist.

- Ans
- 1. Sarod
 - 2. Sitar
 - 3. Shehnai
 - 4. Santoor

Q.15 Which of the following statements is INCORRECT regarding the collegium system?
Ans 1. This system was evolved through Supreme Court judgment.
 2. It consists of Chief Justice and four senior judges of Supreme Court.
 3. It recommends the appointments and transfers of judges.
 4. This system started in the year 2007.

Q.16 How many openings does the digestive system in Platyhelminthes have?
Ans 1. Double
 2. Single
 3. Triple
 4. Indefinite

Q.17 Which of the following plans was introduced in the year 1945, before planned economic development began in India?
Ans 1. The People's Plan
 2. The Bombay Plan
 3. The Sarvodaya Plan
 4. The Gandhian Plan

Q.18 Which of the following is an example of the cooperative sector industry?
Ans 1. Coir Industry
 2. Dabur Industry
 3. Bajaj Auto Limited
 4. Steel Authority of India Limited

Q.19 Which of the tides have variations in height?
Ans 1. Neap tide
 2. Mixed tide
 3. Semi diurnal tide
 4. Diurnal tide

Q.20 In the mid-eighth century, Dantidurga, a Rashtrakuta chief overthrew his Chalukya overlord and performed a ritual called _____.
Ans 1. Deva Yajna
 2. Ashvamedha Yajna
 3. Rajasuya Yajna
 4. Hiranya-Garbha Yajna

Q.21 A dispute petition in the election of the President of the India can be filed in:
Ans 1. Both, the Supreme Court of India and the High Court of any state
 2. Only the Supreme Court of India
 3. Only the Delhi High Court
 4. Any court within the territory of India

Q.22 Kavadi Aattam is a major folk dance form of which of the following states of India?
Ans 1. Tamil Nadu
 2. Kerala
 3. Karnataka
 4. Sikkim

Q.23 The Vithal temple of Hampi has _____ columns that produce musical notes.

- Ans
- 1. 75
 - 2. 63
 - 3. 49
 - 4. 56

Q.24 'My Country My life', is the autobiography of which of the following ex-Deputy Prime Minister of India?

- Ans
- 1. Lal Krishna Advani
 - 2. Morarji Desai
 - 3. Vallabh Bhai Patel
 - 4. Jagjivan Ram

Q.25 To grant autonomy to firms, some public sector units were given special status. Which of the following was NOT one of the statuses?

- Ans
- 1. Devratnas
 - 2. Maharatnas
 - 3. Navratnas
 - 4. Miniratnas

Q.26 Which of the following is considered to be the most liquid asset?

- Ans
- 1. Land
 - 2. Bond
 - 3. Gold
 - 4. Money

Q.27 Who was the Minister of Finance when the economic reforms of 1991 took place in India?

- Ans
- 1. Dr. Manmohan Singh
 - 2. Mr. Bimal Jalan
 - 3. Mr. P Chidambaram
 - 4. Mr. Pranab Mukherjee

Q.28 Who among the following gave Tansen the title of 'Mian'?

- Ans
- 1. Shah Jahan
 - 2. Babur
 - 3. Humayun
 - 4. Akbar

Q.29 Which of the following is NOT a salient feature of liberalisation?

- Ans
- 1. Abolishment of industrial licensing
 - 2. Selling part of equity shares of public sector undertakings to public
 - 3. Autonomy to determine the prices
 - 4. De-reservation of goods for small scale industry

Q.30 When was the Sampoorna Grameen Rozgar Yojana launched?

- Ans
- 1. 2001
 - 2. 2002
 - 3. 2000
 - 4. 2003

Q.31 Which of the following is a major inorganic source of food?

- Ans
- 1. Meat
 - 2. Vegetables
 - 3. Water
 - 4. Grains

Q.32 Which organisation releases the official poverty estimates in India based on data collected from the National Sample Survey Office (NSSO) and other sources?

- Ans
- 1. NITI Aayog
 - 2. Reserve Bank of India
 - 3. Ministry of Finance
 - 4. World Bank

Q.33 Which of the following additions in the Indian Constitution was based on the suggestions of the Swaran Singh Committee?

- Ans
- 1. Fundamental Duties
 - 2. Emergency Provisions
 - 3. Directive Principles of State Policy
 - 4. Fundamental Rights

Q.34 The Republic Day parade, in the year 1955, was organised at which of the following places in Delhi?

- Ans
- 1. Rajpath
 - 2. Parliament House Street
 - 3. Rajghat
 - 4. Old Fort

Q.35 In the year 2022, Arjun Singh Dhurve was conferred the Padma Shri for his contribution to which of the following dance forms?

- Ans
- 1. Kathak
 - 2. Baiga Tribal Dance
 - 3. Chhau
 - 4. Bharatanatyam

Q.36 The Communist Party of India was formed in 1925 at the first Party Conference in _____.

- Ans
- 1. Kanpur
 - 2. Delhi
 - 3. Madras
 - 4. Bombay

Q.37 The measurement of a kho-kho field must be _____.

- Ans
- 1. 28×15 m
 - 2. 30×15 m
 - 3. 29×16 m
 - 4. 27×16 m

Q.38 Which of the following nations won the third blind cricket World Cup T20 championship?

- Ans
- 1. India
 - 2. Bangladesh
 - 3. Pakistan
 - 4. Sri Lanka

Q.39 Which of the following claims about abiotic is false?

- Ans
- 1. They are the living components of the ecosystem
 - 2. Water is an abiotic component of the ecosystem
 - 3. Abiotic components of the ecosystem were never alive
 - 4. They are the non-living components of the ecosystem

Q.40 In which of the following years had Bal Gangadhar Tilak founded the Home League?

- Ans
- 1. 1934
 - 2. 1916
 - 3. 1924
 - 4. 1912

Q.41 On which of the following days is Netaji Subash Chandra Bose's birth anniversary celebrated?

- Ans
- 1. 16 January
 - 2. 23 March
 - 3. 14 November
 - 4. 23 January

Q.42 Who among the following had written the 'Kamayani'?

- Ans
- 1. Jaishankar Prasad
 - 2. Amrita Pritam
 - 3. Mahadevi Verma
 - 4. Sumitranandan Pant

Q.43 Which report of the Second Administrative Reforms Commission is related to the recommendations on Panchayati Raj?

- Ans
- 1. 4th
 - 2. 5th
 - 3. 6th
 - 4. 3rd

Q.44 The Rourkela Steel Plant was developed with the collaboration of _____.

- Ans
- 1. Germany
 - 2. Japan
 - 3. France
 - 4. Britain

Q.45 Which of the following statements about hurricanes is true?

- Ans
- 1. Related to Western Pacific
 - 2. Related to Western Australia
 - 3. Related to Atlantic
 - 4. Related to Indian ocean

Q.46 The Congress and the Muslim League signed the historic _____ in 1916.

- Ans
- 1. Delhi Pact
 - 2. Lucknow Pact
 - 3. Lahore Pact
 - 4. Surat Pact

Q.47 Which of the following is/are meant for promoting the ideals of social and economic democracy?

- Ans**
- 1. Directive Principles of State Policy
 - 2. Fundamental Duties
 - 3. Co-Operative Societies
 - 4. Single Citizenship

Q.48 Which famous Chinese philosopher and scholar emphasised the importance of ethical values, family relationships and social harmony in his teachings?

- Ans**
- 1. Sun Tzu
 - 2. Laozi
 - 3. Confucius
 - 4. Mao Zedong

Q.49 After which incident did Mahatma Gandhi call off the non-cooperation movement?

- Ans**
- 1. Chauri Chaura killing in 1922
 - 2. Jallianwala Bagh massacre of 1919
 - 3. Chauri Chaura killing in 1925
 - 4. Jallianwala Bagh massacre of 1922

Q.50 Which of these dances is commonly performed in Odisha?

- Ans**
- 1. Raas Leela
 - 2. Ghumura
 - 3. Chakyar Koothu
 - 4. Grida dance

Section : Reasoning

Q.1 Select the option that is related to the fifth letter-cluster in the same way as the second letter-cluster is related to the first letter-cluster and the fourth letter-cluster is related to the third letter-cluster.
BOAT : XESF :: MANY : CREQ :: TIME : ?

- Ans**
- 1. JQMX
 - 2. IQMX
 - 3. JQMW
 - 4. IQNY

Q.2 Select the correct mirror image of the given figure when the mirror is placed at PQ as shown below.



Ans

- ✗ 1. 2^%\$!@HFEF
- ✗ 2. 2^%\$!@HFEF
- ✗ 3. 2^%\$!@HFEF
- ✓ 4. 2^%\$!@HFEF

Q.3 The given figure is followed by four option figures. Select the option figure in which this figure is embedded (i.e., contains this figure in the same form; rotation is NOT allowed).

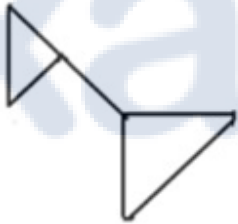

Ans

- ✗ 1.
- ✓ 2.
- ✗ 3.
- ✗ 4.

Q.4 Observe the dots on a dice (one to six dots) in the following figures. How many dots are contained on the face of that containing four dots?

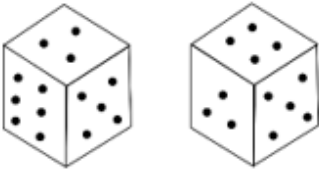

- Ans
- 1. One
 - 2. Three
 - 3. Two
 - 4. Six

Q.5 Select the option that represents the letters that, when sequentially placed from left to right in the blanks below, will complete the letter series.

C _ E _ T _ W _ R T C W _ R _ C W E _ _

- Ans
- 1. WRCEERTT
 - 2. WRCERERT
 - 3. WRCETERT
 - 4. WRCERTRT

Q.6 Select the figure from among the given options that can replace the question mark (?) in the following series.

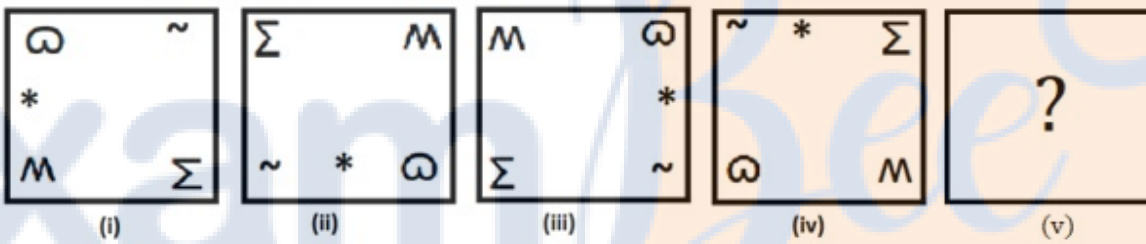

Ans

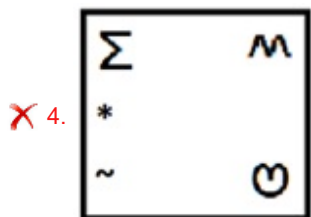
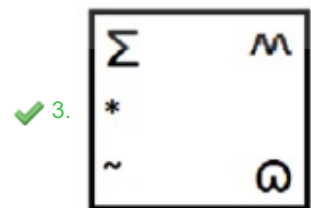
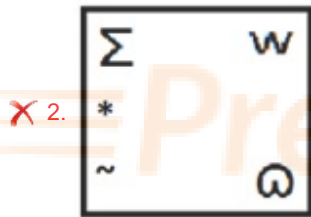
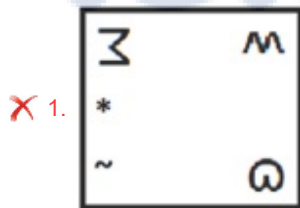

Q.7 Select the set in which the numbers are related in the same way as are the numbers of the following sets.
(NOTE: Operations should be performed on the whole numbers, without breaking down the numbers into its constituent digits. E.g. 13 – Operations on 13 such as adding/subtracting/multiplying etc. to 13 can be performed. Breaking down 13 into 1 and 3 and then performing mathematical operations on 1 and 3 is not allowed)
(7, 16, 168)
(3, 28, 126)

- Ans**
- 1. (9, 17, 153)
 - 2. (11, 18, 396)
 - 3. (6, 11, 99)
 - 4. (8, 7, 136)

Q.8 Six friends Farheen, Pooja, Richa, Sonika, Vani and Tanya are sitting around a circular table facing the centre. Farheen is an immediate neighbour of both Pooja and Richa. Sonika is sitting second to the right of Pooja. Vani is sitting third to the left of Richa. Tanya is an immediate neighbour of both Sonika and Richa. Who sits to the immediate left of Tanya?

- Ans**
- 1. Sonika
 - 2. Richa
 - 3. Pooja
 - 4. Farheen

Q.9 Which figure should replace the question mark (?) if the following series were to be continued?

	3		C		P		3		A						
P	□	C	3	L	A	A	C	3	P	S	L	L	3	P	?
A		P			L			A		S					

- Ans**
- 1.

	P	
A	♥	S
L		
 - 2.

	P	
A	3	S
L		
 - 3.

	P	
S	♥	A
L		
 - 4.

	S	
P	L	3
A		

Q.10 How many squares are there in the given figure?

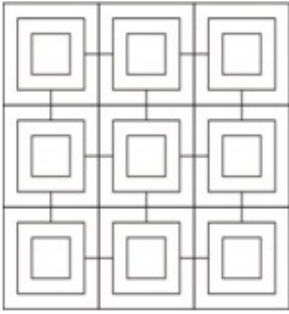

- Ans
- 1. 40
 - 2. 36
 - 3. 32
 - 4. 30

Q.11 Select the figure that will replace the question mark (?) in the following figure series.



- Ans
- 1.
 - 2.
 - 3.
 - 4.

Q.12 Which of the following options will replace the question mark (?) in the given series?
71, 213, 639, 1917, 5751, ?

- Ans
- 1. 16509
 - 2. 19479
 - 3. 17253
 - 4. 11643

Q.13 Read the given statements and conclusions carefully. Assuming that the information given in the statements is true, even if it appears to be at variance with commonly known facts, decide which of the given conclusions logically follow(s) from the statements.

Statements:

Some backpacks are bags.

All backpacks are luggage.

Conclusions:

I. Some luggage are bags.

II. Some luggage are backpacks.

- Ans
- 1. Neither conclusion I nor II follows
 - 2. Only conclusion I follows
 - 3. Only conclusion II follows
 - 4. Both conclusions I and II follow

Q.14 In a certain code language, 'ORBIT' is written as 'SHAQN' and 'PLANT' is written as 'SMZKO'. How will 'PLUTO' be written in that language?

- Ans
- ✓ 1. NSTKO
 - ✗ 2. SSTKQ
 - ✗ 3. NSTKP
 - ✗ 4. OKTSN

Q.15 Six numbers 1, 2, 3, 4, 5 and 6 are written on different faces of a dice. Two positions of this dice are shown in the figure. Find the number on the face opposite to 5.

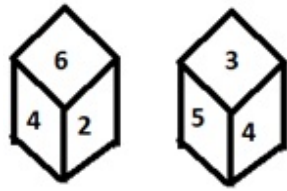

- Ans
- ✗ 1. 2
 - ✓ 2. 6
 - ✗ 3. 3
 - ✗ 4. 1

Q.16 Select the option in which the given figure is embedded (rotation is NOT allowed).

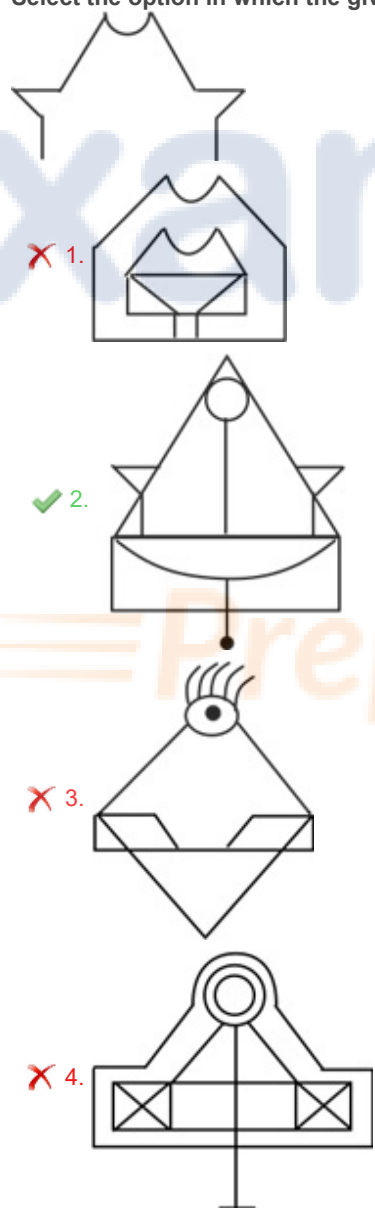

- Ans
- ✗ 1.
 - ✓ 2.
 - ✗ 3.
 - ✗ 4.

Q.17 Select the correct mirror image of the given figure when the mirror is placed at MN as shown below.

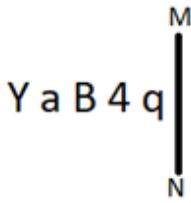

- Ans
- 1. b 4 B a Y
 - 2. ʌ a B 4 q
 - 3. p 4 B 9 ʌ
 - 4. p 4 B 9 Y

Q.18 Select the option that is related to the fourth number in the same way as the first number is related to the second number and the fifth number is related to the sixth number.

$$216 : 344 :: ? : 126 :: 27 : 65$$

- Ans
- 1. 64
 - 2. 66
 - 3. 68
 - 4. 70

Q.19 Which two signs should be interchanged to make the following equation correct?

$$14 \times 2 \div 9 - 5 + 18 = 76$$

- Ans
- 1. + and +
 - 2. + and ×
 - 3. - and +
 - 4. - and ×

Prepare 50% Faster

Q.20 The sequence of folding a piece of paper and the manner in which the folded paper has been cut is shown below figure which would most closely resemble the unfolded form of the paper.

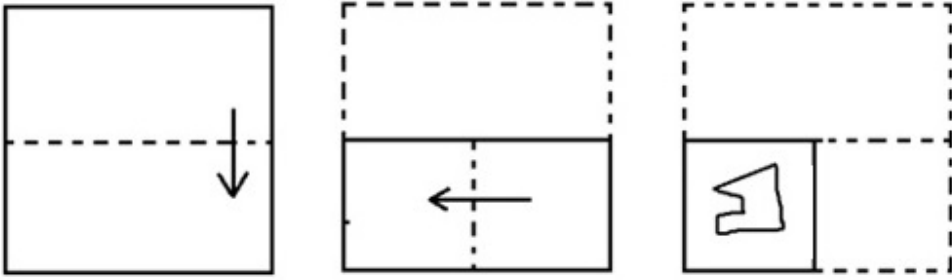

Ans

X 1.

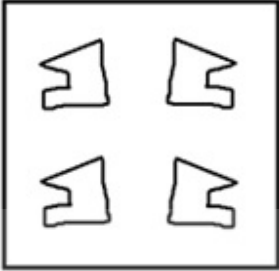

X 2.

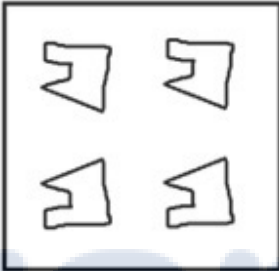

X 3.

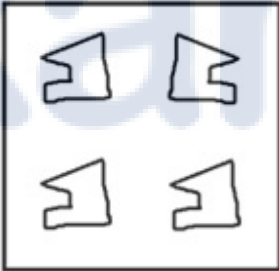

✓ 4.

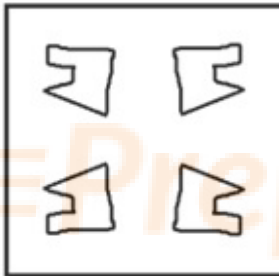

Q.21 Select the option in which the given figure is embedded (rotation is NOT allowed).

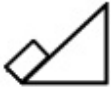

Ans

1.



2.



3.

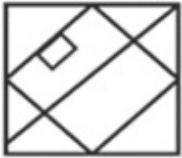

4.



Q.22 Select the correct combination of mathematical signs to sequentially replace the * signs and to balance the given equation.
 $8 * 1 * 4 * 2 * 16 * 2 * 8$

1. $\div \times - + \times =$

2. $+ - + \times \times =$

3. $\times + \times - + =$

4. $= \times + \times + -$

Q.23 Select the correct mirror image of the given figure when the mirror is placed at PQ as shown below.

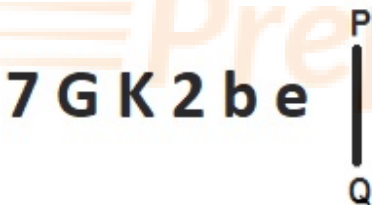

1. e p e 7 G K 2 b

2. e p e 7 G K 2 b

3. e p e 7 G K 2 b

4. e p e 7 G K 2 b

Q.24 Select the correct mirror image of the given figure when the mirror is placed at PQ as shown below.

G t F 6 7 A 2

P
|
Q

- Ans
- 1. Ɔ A 7 9 Ɔ Ɔ Ɔ
 - 2. 2 A 7 9 Ɔ Ɔ Ɔ
 - 3. Ɔ A 7 9 Ɔ Ɔ Ɔ
 - 4. G t F 6 7 A 2



Prepare 50% Faster

Q.25 Choose the option figure in which the problem figure is hidden/embedded. (Rotation is not allowed)

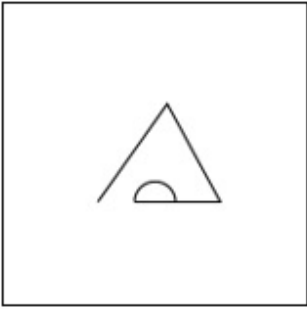

Ans

X 1.

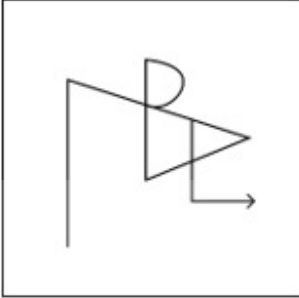

X 2.

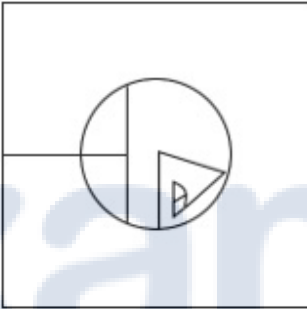

X 3.



✓ 4.

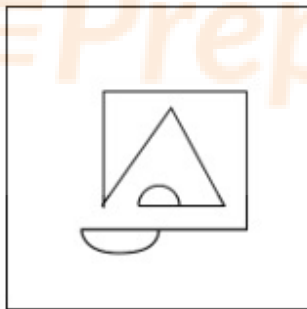

Section : Numerical Ability

Q.1 Simplify the following.

$$\frac{\frac{6}{7} + \frac{2}{3}}{\frac{1}{6} - \frac{3}{20}}$$

- Ans
- 1. $\frac{640}{7}$
 - 2. $\frac{16}{630}$
 - 3. $\frac{640}{133}$
 - 4. $\frac{80}{7}$

Q.2 The cost of an item increased to ₹250 from ₹225. What is the percentage increase in the cost?

- Ans
- 1. 16.66%
 - 2. 13.33%
 - 3. 11.11%
 - 4. 9.5%

Q.3 If the average of 10 numbers is 625 and the average of 25 numbers is 100, then the average of 35 numbers is equal to _____.

- Ans
- 1. 66.5
 - 2. 362.5
 - 3. 315
 - 4. 250

Q.4 A certain sum amounts to ₹1,725 in 3 years and ₹1,875 in 5 years on simple interest. The interest rate per annum is:

- Ans
- 1. 7%
 - 2. 5%
 - 3. 6%
 - 4. 4%

Q.5 A football can occupy 36π cm³ of air. Its radius (in cm) will be:

- Ans
- 1. 2
 - 2. 4
 - 3. 3
 - 4. 5

Q.6 Two stations, A and B are 100 km apart on a straight line. One train starts from A at 7 A.M. and travels towards B at a speed of 20 km/h. Another train starts from B at 8 A.M. and travels towards A at a speed of 25 km/h. At what time they will meet?

- Ans
- 1. 10.47 A.M.
 - 2. 11.05 A.M.
 - 3. 10.37 A.M.
 - 4. 9.47 A.M.

Q.7 If the product of two co-prime numbers is 306, then the LCM of the numbers is:

- Ans
- 1. 306
 - 2. 153
 - 3. 17
 - 4. 18

Q.8 A shopkeeper sells two articles at a ₹840 each. He earns a 20% profit on the first article and incurs a 20% loss on the second article. Determine the percentage of net profit or loss he incurs.

- Ans
- 1. Loss of 3%
 - 2. Loss of 5%
 - 3. Loss of 4%
 - 4. Profit of 5%

Q.9 Find the area of triangle whose sides are 6 cm, 8 cm and 10 cm long.

- Ans
- 1. 24 cm²
 - 2. 28 cm²
 - 3. 20 cm²
 - 4. 12 cm²

Q.10 A can complete a work in 16 days and B can complete the same work in 26 days. What will be the number of days required by A and B to complete the same work together?

- Ans
- 1. $7\frac{8}{21}$
 - 2. $9\frac{19}{21}$
 - 3. $11\frac{20}{21}$
 - 4. $8\frac{11}{21}$

Q.11 Which of the following is the largest ratio?

- Ans
- 1. 4 : 5
 - 2. 6 : 5
 - 3. 7 : 10
 - 4. 3 : 5

Q.12 In an election between R and S, R wins the election with $\frac{1}{4}$ votes of the votes polled in favour of S. There are no invalid votes. What percentage (rounded off to 2 decimal places) of total votes are voted in favour of R?

- Ans
- 1. 60.56%
 - 2. 55.56%
 - 3. 52.56%
 - 4. 57.56%

Q.13 There are four prime numbers written in ascending order. The product of the first three is 30 and that of the last three is 210. Find the last number.

- Ans**
- 1. 13
 - 2. 17
 - 3. 11
 - 4. 7

Q.14 A shopkeeper gives a discount of 10% on the marked price. If the selling price is ₹6,750, then find the discount.

- Ans**
- 1. ₹700
 - 2. ₹800
 - 3. ₹750
 - 4. ₹650

Q.15 The compound amount of a certain sum of money in 2 years and 3 years becomes ₹12,260 and ₹12,873, respectively. Find the rate of interest.

- Ans**
- 1. 5%
 - 2. 6%
 - 3. 7%
 - 4. 4%

Section : Computer Proficiency

Q.1 In MS Excel 365, which of the following is the shortcut key in MS Excel to print a spread sheet?

- Ans**
- 1. Ctrl + P
 - 2. Ctrl + I
 - 3. Alt + I
 - 4. Alt + P

Q.2 In MS Excel 365, in which of the following Ribbon tabs does the add rows option reside in MS Excel 365?

- Ans**
- 1. Home → File
 - 2. Home → Format
 - 3. Home → Edit
 - 4. Home → Insert

Q.3 Which technology is commonly used for sending and receiving electronic mail?

- Ans**
- 1. Telephony
 - 2. Internet and email protocols
 - 3. Postal services
 - 4. Fax machines

Q.4 What is the full form of NetBIOS?

- Ans**
- 1. Networking Binary Input / Output System
 - 2. Net Binary In / Out System
 - 3. Network Basic Input / Output System
 - 4. Network Based Input / Output System

Q.5 In MS Excel 365, Which of the following shortcut keys is used to save a workbook in MS Excel?

- Ans**
- 1. F1
 - 2. Ctrl+A
 - 3. F6
 - 4. Ctrl+S

Q.6 Which of the following is a commonly used word processing package?

- Ans**
- 1. Microsoft Word
 - 2. Microsoft Excel
 - 3. Adobe Photoshop
 - 4. Google Chrome

Q.7 The group of buttons or icons below the menu bar in a word processing software are called:

- Ans**
- 1. toolbars
 - 2. dialog boxes
 - 3. menus
 - 4. status bars

Q.8 Which of the following CANNOT be the default font size in the font-menu dropdown list in MS Word 365 in Windows 10?

- Ans**
- 1. 9
 - 2. 10
 - 3. 13
 - 4. 11

Q.9 Which of the following is the correct shortcut key used to increase paragraph indentation in MS Word 365?

- Ans**
- 1. Ctrl + M
 - 2. Ctrl + Tab
 - 3. Ctrl + L
 - 4. Ctrl + I

Q.10 Which of the following is/are parts of the standard Structure of Electronic mail?

- Ans**
- 1. Both Header and Body
 - 2. Neither Header nor Body
 - 3. Only Header
 - 4. Only Body

Prepare 50% Faster

Constable Executive Male and Female in Delhi Police Examination 2023

Exam Date	20/11/2023
Exam Time	3:00 PM - 4:30 PM
Subject	Constable Executive Male and Female in Delhi Police Examination 2023

Section : General Knowledge

Q.1 निम्नलिखित में से कौन-सा 37वें राष्ट्रीय खेलों का शुभंकर है?

- Ans
- 1. भीमा
 - 2. मोगा
 - 3. ऑली
 - 4. सावज

Q.2 निम्नलिखित में से किस नृत्यांगना ने प्रसिद्ध बैलेरीना अन्ना पावलोवा (Anna Pavlova) के अनुरोध पर बैले सीखा?

- Ans
- 1. सोनल मानसिंह
 - 2. रुक्मिणी देवी अरुंडेल
 - 3. सितारा देवी
 - 4. यामिनी कृष्णमूर्ति

Q.3 निम्नलिखित में से कौन-सा अनुच्छेद निर्देशक सिद्धांतों को 'देश के शासन में मौलिक' के रूप में निहित करता है और 'कानून बनाने में इन सिद्धांतों को लागू' करने की राज्य से अपेक्षा करता है?

- Ans
- 1. अनुच्छेद 36
 - 2. अनुच्छेद 37
 - 3. अनुच्छेद 39
 - 4. अनुच्छेद 38

Q.4 Which crop is also known as 'golden fibre'?

- Ans
- 1. Rice
 - 2. Wheat
 - 3. Jute
 - 4. Cotton

Q.5 Dharmapala of Pala dynasty was defeated by which of the following Rashtrakuta rulers?

- Ans
- 1. Dhruva
 - 2. Krishna I
 - 3. Govinda II
 - 4. Amoghavarsha II

Q.6 Which of the following does not fall within the Census of India's definition of a town?

- Ans
- 1. Presence of municipality, corporation, etc
 - 2. Population density of 400 persons per km²
 - 3. More than 75% of the population engaged in primary sector
 - 4. Have a minimum population of 5000 persons

Q.7 From where does most of the refracted light rays enter the eyes?

- Ans
- 1. From the outer surface of the iris
 - 2. From the inner surface of the cornea
 - 3. From the outer surface of the cornea
 - 4. From the outer surface of the retina

Q.8 In which year did Lord Curzon arrive in India as Viceroy?

- Ans
- 1. 1891
 - 2. 1899
 - 3. 1898
 - 4. 1892

Q.9 शिक्षा के क्षेत्र में एक योजना 'समग्र शिक्षा', _____ से संबंधित पहले की योजनाओं को समाहित करती है।

- Ans
- 1. केवल सर्व शिक्षा अभियान और राष्ट्रीय माध्यमिक शिक्षा अभियान
 - 2. केवल सर्व शिक्षा अभियान
 - 3. केवल सर्व शिक्षा अभियान, राष्ट्रीय माध्यमिक शिक्षा अभियान और शिक्षक शिक्षा
 - 4. केवल सर्व शिक्षा अभियान, शिक्षक शिक्षा और राष्ट्रीय आविष्कार अभियान

Q.10 In which year was the Right to Education (RTE) Act implemented?

- Ans
- 1. 2012
 - 2. 2009
 - 3. 2010
 - 4. 2015

Q.11 Which of the following authors has written the famous novel 'Gulliver's Travels'?

- Ans
- 1. Jonathan Swift
 - 2. Samuel Richardson
 - 3. Ruskin Bond
 - 4. Oscar Wilde

Q.12 Who has the power to grant pardons, reprieve, respites or remissions of punishment?

- Ans
- 1. Vice President
 - 2. President
 - 3. Speaker
 - 4. Prime minister

Q.13 संसद _____ की सिफारिश पर राज्य विधान-परिषद बना या समाप्त कर सकती है।

- Ans
- 1. मुख्यमंत्री
 - 2. भारत के राष्ट्रपति
 - 3. राज्य विधानसभा
 - 4. राज्य के राज्यपाल

Q.14 The thickness of the continental crust beneath the Central Himalayas is of the order of _____, marking the end of volcanic activity in the region.

- Ans
- 1. 50–63 km
 - 2. 60–65 km
 - 3. 35–37 km
 - 4. 70–72 km

Q.15 Who was the author of 'Raag Darbari'?

- Ans
- 1. Dharamvir Bharati
 - 2. Shrilal Shukla
 - 3. Suryakant Tripathi 'Nirala'
 - 4. Harivansh Rai Bachchan

Q.16 Which farming technique was promoted by the Green Revolution against traditional farming?

- Ans
- 1. Scientific farming
 - 2. Labour intensive farming
 - 3. Indigenous farming
 - 4. Organic farming

Q.17 As per the CMIE's report in December 2022, what was the unemployment rate of the urban population in India?

- Ans
- 1. 10.09%
 - 2. 12.03%
 - 3. 8.12%
 - 4. 11.09%

Q.18 The prime among the various sources of Aryan culture are _____.

- Ans
- 1. ritual texts
 - 2. inscriptions
 - 3. monuments
 - 4. archaeological artifacts

Q.19 Under which function of the Union Budget does the Government of India build roads and hospitals?

- Ans
- 1. Surplus generation
 - 2. Allocation
 - 3. Redistribution
 - 4. Stabilisation

Q.20 Who among the following presides over the joint sitting of the parliament?

- Ans
- 1. The President of India
 - 2. The Prime Minister of India
 - 3. The Chairman of Rajya Sabha
 - 4. The Speaker of Lok Sabha

Q.21 In terms of total passengers, which was the biggest airport in India in the year 2022?

- Ans
- 1. Rajiv Gandhi International Airport (Hyderabad)
 - 2. Kempegowda International Airport (Bengaluru)
 - 3. Chhatrapati Shivaji Maharaj International Airport (Mumbai)
 - 4. Indira Gandhi International Airport (Delhi)

Q.22 Belgium won the Men's International Federation Hockey (FIH) 2018 World Cup, which was held in _____.

- Ans
- 1. Belgium
 - 2. India
 - 3. Australia
 - 4. Germany

Q.23 साहित्य अकादमी पुरस्कार विजेता माया खुटेगांवकर एक प्रसिद्ध _____ नृत्यांगना हैं।

- Ans
- 1. बिहु
 - 2. सुग्गी
 - 3. झूमर
 - 4. लावणी

Q.24 Which system was prevalent before the invention of money?

- Ans
- 1. Barter system
 - 2. Liquidity system
 - 3. Bretton woods system
 - 4. Fiscal system

Q.25 The amphibians of plant kingdom are _____.

- Ans
- 1. Fungi
 - 2. Pteridophytes
 - 3. Algae
 - 4. Bryophytes

Q.26 Which of the following is a famous folk dance of Bihar?

- Ans
- 1. Maharas
 - 2. Naga dance
 - 3. Jhijhiya
 - 4. Khel gopal

Q.27 Who among the following became the first Indian musician to be honoured with the Ramon Magsaysay award, which is considered to be Asia's Nobel Prize?

- Ans
- 1. Lata Mangeskar
 - 2. MS Subbulakshmi
 - 3. Pandit Ravi Shankar
 - 4. Pandit Kumar Gandarva

Q.28 Amaravati Stupa is located in which of these states?

- Ans
- 1. Andhra Pradesh
 - 2. Gujarat
 - 3. Madhya Pradesh
 - 4. West Bengal

Q.29 Which month marks the approximate arrival of the monsoon in India?

- Ans
- 1. Early January
 - 2. Early October
 - 3. Early February
 - 4. Early June

Q.30 The first woman's organisation of India, Bharat Stree Mahamandal was founded by:

- Ans
- 1. Sarala Devi Chaudhurani
 - 2. Annie Besant
 - 3. Savitribai Phule
 - 4. Sarojini Naidu

Q.31 Badshah Nama was written by _____.

- Ans
- 1. Bairam Khan
 - 2. Sadullah Khan
 - 3. Abu'l Fazi
 - 4. Abdul Hamid Lahori

Q.32 Which female singer got the 'Best Playback Singer (Female)' award at the Filmfare Awards 2022?

- Ans
- 1. Priya Saria
 - 2. Shreya Ghoshal
 - 3. Neha Kakkar
 - 4. Asees Kaur

Q.33 Which of the following organisations regulates international trade?

- Ans
- 1. UNESCO
 - 2. IMF
 - 3. UNICEF
 - 4. WTO

Q.34 The Directive Principles of State Policy resemble the 'Instrument of Instructions' in the:

- Ans
- 1. Government of India Act, 1919
 - 2. Indian Independence Act, 1947
 - 3. Government of India Act, 1935
 - 4. Government of India Act, 1909

Q.35 भारत के पश्चिमी तटीय क्षेत्रों में मानसून का मौसम समाप्त होने के उपलक्ष्य में हिंदू माह श्रावण के आखिरी दिन कौन सा पर्व मनाया जाता है?

- Ans
- 1. साम्बा दशमी
 - 2. नराली पूर्णिमा
 - 3. गुरु पूर्णिमा
 - 4. कोजागिरी पूर्णिमा

Q.36 In 1882, the headquarters of the Theosophical society was established at _____.

- Ans
- 1. Adyar
 - 2. Allahabad
 - 3. Gwalior
 - 4. Calcutta

Q.37 Which of the following Constitutional Amendment Acts made it a fundamental duty of parents to educate their child?

- Ans
- 1. 87th Amendment Act
 - 2. 88th Amendment Act
 - 3. 86th Amendment Act
 - 4. 85th Amendment Act

Q.38 गणतंत्र दिवस परेड में उत्सव के संदर्भ में 25-पॉन्डर्स क्या है?

- Ans
- 1. घुड़सवार सेना द्वारा मार्च पास्ट
 - 2. राष्ट्रपति के अंगरक्षकों द्वारा राष्ट्रीय ध्वज को सलामी
 - 3. विभिन्न राज्यों की झांकियों की प्रस्तुति
 - 4. भारतीय सेना की सात तोपों की सलामी

Q.39 The construction of the Iron Pillar at Mehrauli was undertaken by the rulers of which of the following dynasties?

- Ans**
- 1. Kushan
 - 2. Maukhari
 - 3. Maurya
 - 4. Gupta

Q.40 Which of the following is NOT an amphibian animal?

- Ans**
- 1. Frog
 - 2. Salamander
 - 3. Tortoise
 - 4. Toad

Q.41 In which of the following styles of temple architecture is the shikhara called the Deul?

- Ans**
- 1. Odisha
 - 2. Nagara
 - 3. Vesara
 - 4. Dravidian

Q.42 Which of the following measures is NOT related to the tax reform measures undertaken during the liberalisation phase?

- Ans**
- 1. Reforms related to indirect taxes
 - 2. Simplification of tax procedures
 - 3. Devaluation of Rupee
 - 4. Reduction in rates of income tax

Q.43 Which unusual flavour is observed in dairy products due to the formation of ethyl esters catalysed by esterases produced by lactic acid bacteria?

- Ans**
- 1. Fishy flavour
 - 2. Bitty flavour
 - 3. Musty flavour
 - 4. Fruity flavour

Q.44 In which of the following years was Sati, the practice of widow-burning, banned in India?

- Ans**
- 1. 1829
 - 2. 1819
 - 3. 1897
 - 4. 1875

Q.45 In which Olympics did Khashaba Jadhav, the first Indian win an individual Olympic medal for India?

- Ans**
- 1. 1936 Berlin Olympics
 - 2. 1952 Helsinki Olympics
 - 3. 1972 Munich Olympics
 - 4. 1948 London Olympics

Q.46 The 'Infant Mortality Rate' is defined as the number of deaths of infants aged less than one year per _____ live births in a given year.

- Ans**
- 1. 100
 - 2. 5000
 - 3. 500
 - 4. 1000

Q.47 Which of the following pairs is NOT correctly matched with respect to the player and sport?

- Ans**
- 1. Bhavina Patel – Para-shooting
 - 2. Nishad Kumar – High jump
 - 3. LY Suhas – Para-badminton
 - 4. Yogesh Kathuniya – Discuss throw

Q.48 In which of the following years was the twelfth plan completed?

- Ans**
- 1. 2015
 - 2. 2014
 - 3. 2016
 - 4. 2017

Q.49 Which of the following has a connection to a glacial landform?

- Ans**
- 1. Yardangs
 - 2. Playas
 - 3. Horns
 - 4. Alluvial fan

Q.50 Who among the following is associated with Kathak?

- Ans**
- 1. Anokhelal Mishra
 - 2. Kalamandalam Krishnan Nair
 - 3. V Satyanarayana Sarma
 - 4. Nahid Siddiqui

Section : Reasoning

Q.1 Select the option that represents the letters that, when sequentially placed from left to right in the blanks below, will complete the letter series.

W _ _ S D _ E A S _ W _ A _ D W E A _ _

- Ans**
- 1. EAWDSESD
 - 2. EAWESESD
 - 3. EAWDESSD
 - 4. EAWSEESD

Prepare 50% Faster

Q.2 Which of the following option figures will complete the pattern in the figure given below?

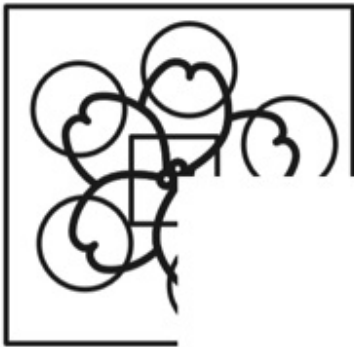

Ans



Q.3 Select the correct mirror image of the given figure when the mirror is placed at MN as shown below.

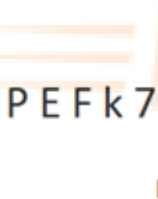

Ans

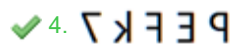
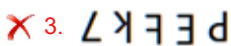
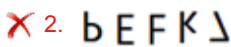
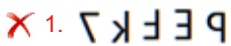

Q.4 Six numbers, 5, 6, 7, 8, 9 and 10, are written on the different faces of a dice. Two positions of this dice are shown in the figure. Find the number on the face opposite to 5.

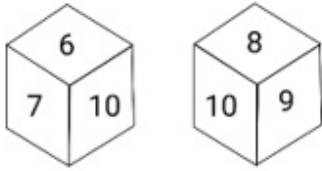

- Ans
- 1. 9
 - 2. 6
 - 3. 10
 - 4. 7

Q.5 Six letters A, B, C, P, Q and R are written on different faces of a dice. Two positions of this dice are shown in the figure. Find the letter on the face opposite to A.



- Ans
- 1. B
 - 2. P
 - 3. C
 - 4. R

Q.6 Select the correct combination of mathematical signs to sequentially replace the * signs and to balance the given equation.
 $18 * 90 * 3 * 27 * 8 = 0$

- Ans
- 1. -, ×, ÷, -
 - 2. ÷, -, ×, +
 - 3. +, ×, -, ÷
 - 4. ×, ÷, +, -

Q.7 Select the option that is related to the third term in the same way as the second term is related to the first term and the sixth term is related to the fifth term.
 $20 : 205 :: 75 : ? :: 105 : 1055$

- Ans
- 1. 755
 - 2. 720
 - 3. 750
 - 4. 785

Q.8 Select the correct mirror image of the given figure when the mirror is placed at MN as shown in

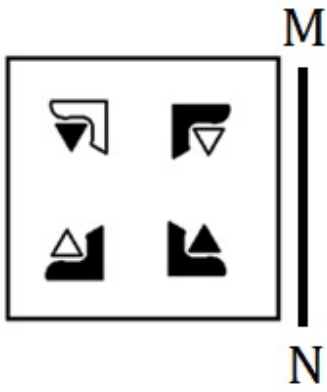

Ans

X 1.



✓ 2.



X 3.



X 4.



Q.9 Select the figure that will replace the question mark (?) in the following figure series.



Ans

1.



2.



3.



4.



Q.10 Select the set in which the numbers are related in the same way as are the numbers of the following sets.
(NOTE: Operations should be performed on the whole numbers, without breaking down the numbers into its constituent digits. E.g. 13 – Operations on 13 such as adding/subtracting/multiplying etc. to 13 can be performed. Breaking down 13 into 1 and 3 and then performing mathematical operations on 1 and 3 is not allowed)
(24, 86, 67)
(39, 64, 71)

Ans 1. (18, 45, 63)

2. (28, 89, 117)

3. (16, 54, 43)

4. (37, 51, 88)

Q.11 Which two signs should be interchanged to make the following equation correct?

$$48 \div 16 \times 24 - 5 + 3 = 12$$

Ans 1. \div and \times

2. \div and $+$

3. $+$ and \times

4. $-$ and $+$

Q.12 Anu, Geeta, Mittal, Radha, Hema and Kriti were sitting around a circular table, facing the centre. They were sitting at an equal distance from one another. Hema and Radha were sitting exactly next to each other. Anu was to the immediate right of Kriti. Geeta was to the immediate left of Hema. Mittal is to the immediate right of Radha. Who among the following is sitting to the immediate left of Geeta?

Ans 1. Hema

2. Radha

3. Anu

4. Kriti

Q.13 Select the figure from the given options that will replace the question mark (?) in the figure given below to complete the pattern so that the final image is symmetrical.

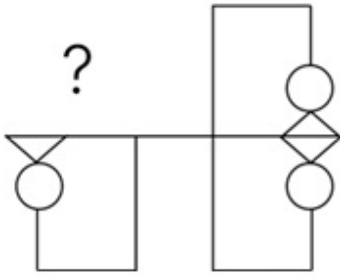

Ans

X 1.

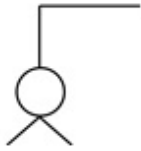

X 2.

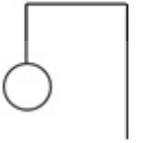

✓ 3.

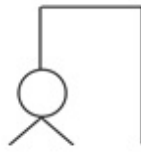

X 4.

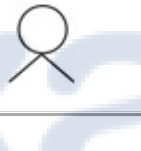

ixamBee

Prepare 50% Faster

Q.14

Which figure from the given options would replace the question mark (?) if the following figure series were to be continued?

2	□	V	8	?
8 V C	V C 8	2 P □	P □ 2	
□	2	8	V	

Ans

✗ 1.

P
V □ 8
2

✗ 2.

V
□ 2 P
8

✗ 3.

2
8 O V
P

✓ 4.

P
V O 8
2

Q.15 उस शब्द-युग्म का चयन कीजिए जिसके शब्दों के बीच वही संबंध है, जो संबंध नीचे दिए गए शब्द-युग्म के शब्दों के बीच है। (शब्दों को अंग्रेजी/हिंदी के अर्थपूर्ण शब्दों के रूप में माना जाना चाहिए और ये शब्द, अक्षरों की संख्या/व्यंजनों/स्वरों की संख्या के आधार पर दूसरे से संबंधित नहीं होने चाहिए।)
असत्य : झूठ

- Ans
- 1. त्रुटि : रेखा
 - 2. सैर : यात्रा
 - 3. ऊंचाई : नियुक्त करना
 - 4. कंबल : ठंड

Q.16 Six numbers, 21, 22, 23, 24, 25 and 26 are written on different faces of a dice. Three positions of this dice are shown here. Find the number on the face opposite 26.

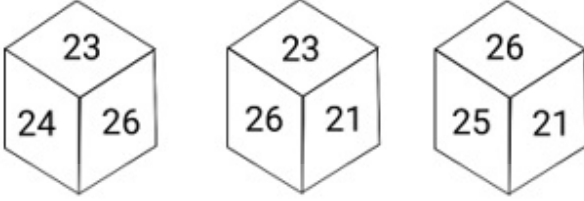

- Ans
- 1. 22
 - 2. 21
 - 3. 23
 - 4. 24

ixamBee

Prepare 50% Faster

Q.17 Select the option which when placed in the blank space of the given figure will complete the pattern.

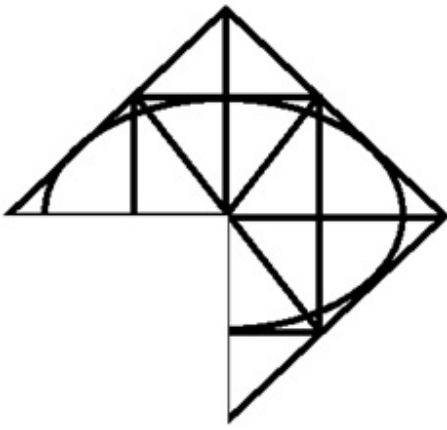

Ans

X 1.

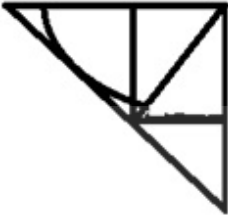

X 2.



✓ 3.



X 4.



Q.18 Which figure should replace the question mark (?) if the series were to be continued?

L	E	O	O	L	E	B	E	S	S	B	E	
	T			B			O			T		?
S	B		T	S		L	T		O	L		

Ans

✗ 1.

B	E	S
	T	
	L	O

✗ 2.

T	E	B
	S	
	L	O

✗ 3.

S	E	L
	T	
	B	O

✓ 4.

T	E	L
	S	
	B	O

Q.19 Select a figure from amongst the four given options, which when placed in the blank space of figure (X) would complete the pattern.

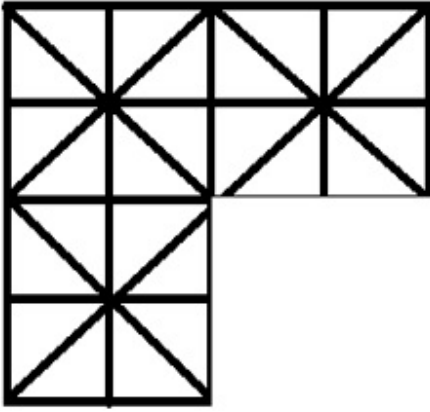

X

Ans

✓ 1.



✗ 2.

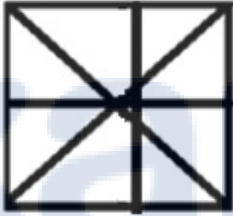

✗ 3.



✗ 4.

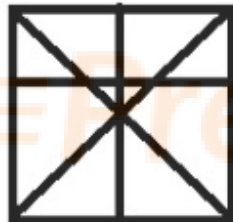

Q.20 How many triangles are there in the given figure?

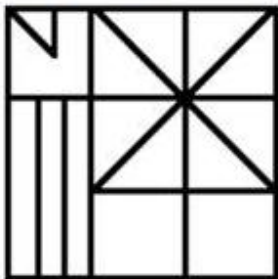

Ans ✗ 1. 15

✓ 2. 17

✗ 3. 12

✗ 4. 14

Q.21 Two statements are given followed by two conclusions numbered I and II. Assuming the statements to be true, even if they seem to be at variance with commonly known facts, decide which of the conclusions logically follow(s) from the statements:
Statements:
 Some camels are donkeys.
 Some donkeys are cows.
Conclusions:
 I. Some cows are camels.
 II. Some donkeys are camels.

- Ans**
- 1. Only conclusion I follows
 - 2. Only conclusion II follows
 - 3. Neither conclusion I nor II follows
 - 4. Both conclusions I and II follow

Q.22 Select the number from among the given options that can replace the question mark (?) in the following series.

3, 18, 63, 198, 603, ?

- Ans**
- 1. 1818
 - 2. 1500
 - 3. 1200
 - 4. 1479

Q.23 Select the correct mirror image of the given combination when the mirror is placed at 'PQ' as shown below.

A 2 4 G P K
 |
 Q

- Ans**
- 1. K 9 G 5 V
 - 2. A 5 4 P K
 - 3. A 5 4 G P K
 - 4. A 5 4 P K

Q.24 Three different positions of the same dice are shown. Find the number on the face opposite the face showing '5'.

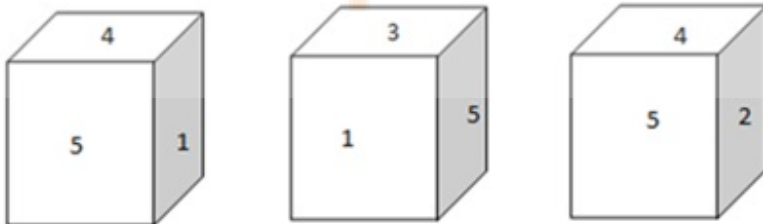

- Ans**
- 1. 6
 - 2. 1
 - 3. 4
 - 4. 3

Q.25 In a certain code language, 'STAY' is written as '2732221' and 'FROM' is written as '1517208'. How will 'FIT' be written in the same language?

- Ans
- 1. 11226
 - 2. 6920
 - 3. 81221
 - 4. 22118

Section : Numerical Ability

Q.1 The ratio of P's salary to Q's salary is 2 : 3. The ratio of Q's salary to R's salary is 4 : 5. What will be the ratio of P's salary to R's salary?

- Ans
- 1. 12 : 15
 - 2. 8 : 12
 - 3. 3 : 5
 - 4. 8 : 15

Q.2 An isosceles right-angled triangle has hypotenuse length as 10 units. What is the area of the triangle (in square units)?

- Ans
- 1. $50\sqrt{2}$
 - 2. 25
 - 3. $25\sqrt{2}$
 - 4. 50

Q.3 A alone can build a house in 16 days, but B alone can build it in 12 days. A and B work on alternate days. If A works on the first day, the house will be built in how many days?

- Ans
- 1. $10\frac{3}{4}$
 - 2. $15\frac{3}{4}$
 - 3. $11\frac{3}{4}$
 - 4. $13\frac{3}{4}$

Q.4 Which of the following groups of numbers has the least number of prime numbers?

- Ans
- 1. From 21 to 40
 - 2. From 30 to 49
 - 3. From 60 to 80
 - 4. From 40 to 60

Q.5 The ratio of two numbers is 5:6. If their HCF is 8, what is the LCM of these two numbers?

- Ans
- 1. 120
 - 2. 360
 - 3. 480
 - 4. 240

Q.6 Simplify $47\frac{37}{50} \times 4\frac{1}{6} \times 24$.

- Ans
- 1. 4762.0
 - 2. 4790.0
 - 3. 4774.0
 - 4. 4782.0

Q.7 A sum of ₹18,910 is divided among Arjun, Raima and Sohan such that Arjun receives 20% less than Raima, while Sohan receives 25% more than Raima's share. What is the share (in ₹) of Sohan?

- Ans
- 1. 7,700
 - 2. 8,470
 - 3. 7,750
 - 4. 8,750

Q.8 The value of a machine, purchased 3 years ago, depreciates at the annual rate of 15%. If its present value is ₹51,20,000, find its value after 4 years.

- Ans
- 1. ₹26,72,672
 - 2. ₹26,67,722
 - 3. ₹27,76,622
 - 4. ₹27,62,267

Q.9 A shopkeeper purchased 12 dozen eggs at the rate of ₹60 per dozen. He sold the eggs at ₹6 per piece. What was his profit percentage?

- Ans
- 1. 10%
 - 2. 15%
 - 3. 20%
 - 4. 25%

Q.10 An article is marked at a price which gives a profit of 20%. After allowing a certain discount, the profit reduces to 10%. The discount percentage is:

- Ans
- 1. $8\frac{1}{3}\%$
 - 2. $7\frac{1}{3}\%$
 - 3. $8\frac{2}{3}\%$
 - 4. $7\frac{2}{3}\%$

Q.11 If a man walks at five-sixth of his usual speed from his home towards his office, he is 20 minutes late. Find the usual time (in minutes) to cover the distance between his home and his office.

- Ans
- 1. 120
 - 2. 100
 - 3. 105
 - 4. 90

Q.12 When adding 18 to a number, the result becomes $122\frac{1}{2}\%$ of the original number.
Find the new number.

- Ans**
- 1. 98
 - 2. 80
 - 3. 82
 - 4. 100

Q.13 Three solid cubes of sides 3 cm, 4 cm and 5 cm are melted to form a new solid cube. Find the surface area (in cm^2) of the cube so formed.

- Ans**
- 1. 343
 - 2. 144
 - 3. 216
 - 4. 125

Q.14 In how much time will a sum of money double itself at a rate of simple interest of 5% per annum?

- Ans**
- 1. 10 years
 - 2. 20 years
 - 3. 12 years
 - 4. 18 years

Q.15 The average of a, b and c is 35 and the average of a, c and d is 40. If $d = 25$, then find the value of b.

- Ans**
- 1. 15
 - 2. 22
 - 3. 10
 - 4. 38

Section : Computer Proficiency

Q.1 What is the primary purpose of a word processing package like Microsoft Word 365?

- Ans**
- 1. Creating spreadsheets
 - 2. Designing presentations
 - 3. Sending emails
 - 4. Creating and editing documents

Q.2 Which of the following shortcut keys is used to get the Help Menu in MS-Word 365?

- Ans**
- 1. Ctrl + F1
 - 2. Shift + F1
 - 3. F1
 - 4. Alt + F1

Q.3 By default, what number of emails in Gmail can be sorted that a user recently received.

- Ans**
- 1. 50
 - 2. 75
 - 3. 25
 - 4. 100

Q.4 In MS Excel _____ have a dollar sign (\$) in front of the row number and/or column letter.

- Ans**
- 1. Only absolute reference
 - 2. Only relative reference
 - 3. Only mixed reference
 - 4. Both absolute reference and mixed reference

Q.5 Which of the following symbols is used to begin a formula in MS Excel 365?

- Ans**
- 1. \$
 - 2. *
 - 3. =
 - 4. &

Q.6 Which of the following is the full form of GPRS?

- Ans**
- 1. General Packet Radio Service
 - 2. General Protocol Radio Service
 - 3. General Packet Release Service
 - 4. Group Packet Radio Service

Q.7 Which of the following shortcut keys is used to justify the text in MS Word 365?

- Ans**
- 1. Ctrl + B
 - 2. Ctrl + U
 - 3. Ctrl + J
 - 4. Ctrl + I

Q.8 When pasting text in Microsoft Word 365, what is the default behaviour if the destination already contains text?

- Ans**
- 1. Prompt the user to choose between overwriting or merging the text.
 - 2. Merge the pasted text with the existing text.
 - 3. Create a new document with the pasted text.
 - 4. Overwrite the existing text.

Q.9 Which of the following functions in MS Excel 365, generates a real number greater than 0 and is really simple and traditionally used for statistical analysis, cryptography, gaming, gambling, and probability theory, among dozens of other things?

- Ans**
- 1. VLOOKUP
 - 2. RAND
 - 3. SUM
 - 4. AVERAGE

Q.10 In Microsoft Word 365, on which page is the header or the footer displayed by default?

- Ans**
- 1. On first page
 - 2. On middle page
 - 3. On last page
 - 4. On every page

Constable Executive Male and Female in Delhi Police Examination 2023

Exam Date	21/11/2023
Exam Time	9:00 AM - 10:30 AM
Subject	Constable Executive Male and Female in Delhi Police Examination 2023

Section : General Knowledge

Q.1 The Permanent Settlement Act in 1793 aimed at an agreement for fixed revenue collection between the East India Company and _____ .

- Ans**
- 1. the common man
 - 2. the labourers
 - 3. the peasants
 - 4. the zamindars

Q.2 The draft of the Fifth five year plan was prepared and launched by _____ .

- Ans**
- 1. DP Dhar
 - 2. Manmohan Singh
 - 3. Bibek Debroy
 - 4. Jaiprakash Narayan

Q.3 Who among the following established the Aligarh Muslim University in 1875?

- Ans**
- 1. Aga Khan
 - 2. Sayyed Ahmad Khan
 - 3. Nawab Salimullah
 - 4. Md Iqbal

Q.4 From which country is the idea of the rule of law taken in the Indian Constitution?

- Ans**
- 1. Germany
 - 2. United Kingdom
 - 3. United States of America
 - 4. France

Q.5 Which of the following festivals is celebrated by the Jain community at Pawapuri in Bihar to mark the attainment of Nirvana by Mahavira?

- Ans**
- 1. Roth Teej
 - 2. Paryushan
 - 3. Deo Deepawali
 - 4. Gyan Panchami

Q.6 In context of precipitation patterns, what does Cf mean in a warm temperate climate?

- Ans**
- 1. Snow precipitation
 - 2. Drizzle precipitation
 - 3. Year-round precipitation
 - 4. Seasonal precipitation

Q.7 What do you mean by 'barter system'?

- Ans
- 1. Purchase of commodity with money
 - 2. Purchase and sale of commodity with commodity
 - 3. Sale of commodity with money
 - 4. No buying or selling

Q.8 'Mintonette' is related to which of the following sports?

- Ans
- 1. Handball
 - 2. Basketball
 - 3. Cricket
 - 4. Volleyball

Q.9 For how many months can a person be appointed as Chief Minister without the membership of the State Legislature?

- Ans
- 1. 6 months
 - 2. 15 months
 - 3. 1 year
 - 4. 2 years

Q.10 Which of the following refers to the transfer of ownership, management and control of public sector enterprises to the entrepreneurs in private sector?

- Ans
- 1. Privatisation
 - 2. Globalisation
 - 3. Liberalisation
 - 4. Licensing

Q.11 The Legislative Assembly alone has the power to originate _____.

- Ans
- 1. drafts
 - 2. writs
 - 3. money bills
 - 4. acts

Q.12 Shakoor Khan is associated with which of the following musical instruments?

- Ans
- 1. Violin
 - 2. Shehnai
 - 3. Sarangi
 - 4. Rudra Veena

Q.13 FDI stands for ____.

- Ans
- 1. Foreign Direct Investment
 - 2. Forex Deregulated Investment
 - 3. Forex Direct Investment
 - 4. Foreign Deregulated Investment

Q.14 Who among the following is an exponent of Vilasini Natyam?

- Ans
- 1. Girija Devi
 - 2. Aditi Mangaldas
 - 3. Leela Samson
 - 4. Swapnasundari

Q.15 The western part of Northern plains is formed by which of the following river systems?

- Ans**
- 1. Brahmaputra and its tributaries
 - 2. Ganga and its tributaries
 - 3. Mahanadi and tributaries
 - 4. Indus and its tributaries

Q.16 What is the interrelationship of a species with all the biotic and abiotic factors affecting it called?

- Ans**
- 1. Ecological niche
 - 2. Habitat
 - 3. Food web
 - 4. Food chain

Q.17 What is study of rocks called?

- Ans**
- 1. Mycology
 - 2. Pomology
 - 3. Petrology
 - 4. Pedology

Q.18 The green revolution was primarily meant for which crops?

- Ans**
- 1. Wheat and Rice
 - 2. Millet and Bajra
 - 3. Bajra and Rice
 - 4. Wheat and Bajra

Q.19 What technique is used in cell biology research for imaging cellular organelles and surface topography?

- Ans**
- 1. Phase contrast microscopy
 - 2. Dark-field microscopy
 - 3. Fluorescence microscopy
 - 4. Scanning electron microscopy

Q.20 Which of the following was instituted especially to look after the military organisation of the Delhi Sultanate?

- Ans**
- 1. Diwan-i-Insha
 - 2. Diwan-i-Arz
 - 3. Diwan-I-Qada
 - 4. Diwan-i-Wizarat

Q.21 Which is the largest component of GDP?

- Ans**
- 1. Investment
 - 2. Net exports
 - 3. Government purchase
 - 4. Consumption

Q.22 National Youth Day is celebrated on the birth date of which of these personalities?

- Ans**
- 1. Netaji Subhash Chandra Bose
 - 2. Vikram Sarabhai
 - 3. Swami Vivekanand
 - 4. APJ Abdul Kalam

Q.23 According to the Census of India 2011, the lowest literacy rate was recorded in _____ Union Territory.

- Ans
- 1. Pondicherry
 - 2. Andaman and Nicobar Islands
 - 3. Dadra and Nagar Haveli
 - 4. Chandigarh

Q.24 According to Census 2011, which union territory of India has the highest sex ratio (Females per 1000 males)?

- Ans
- 1. Delhi
 - 2. Puducherry
 - 3. Daman and Diu
 - 4. Dadra and Nagar Haveli

Q.25 Which of the following ministries had setup National Skill Development Corporation ?

- Ans
- 1. Ministry of Education
 - 2. Ministry of Skill Development and Entrepreneurship
 - 3. Ministry of Finance
 - 4. Ministry of Tribal Affairs

Q.26 Match the columns.

Food material

- i. Starch
- ii. Fat
- iii. Protein
- iv. Halogenoalkane salt

Chemical/reagent/test used for detection

- a. Acrolein test
- b. Biuret test
- c. Iodine
- d. Silver nitrate

- Ans
- 1. i-d, ii-c, iii-b, iv-a
 - 2. i-c, ii-d, iii-a, iv-b
 - 3. i-c, ii-d, iii-b, iv-a
 - 4. i-c, ii-a, iii-b, iv-d

Q.27 Which of the following is NOT one of the 3 most important deities mentioned in Rigveda?

- Ans
- 1. Indra
 - 2. Agni
 - 3. Prajapati
 - 4. Soma

Q.28 According to the UNDP Human Development Report 2021-22, what was the Human Development Index rank of India?

- Ans
- 1. 132
 - 2. 154
 - 3. 114
 - 4. 133

Q.29 Gangmei Aluna Kabuini is a famous tribal 'Kabu' dancer associated with which of the following states?

- Ans
- 1. Goa
 - 2. Odisha
 - 3. Assam
 - 4. Manipur

Q.30 Which Constitutional Amendment Act of 2016 provided for the establishment of a GST Council?

- Ans**
- 1. 103rd
 - 2. 99th
 - 3. 101st
 - 4. 100th

Q.31 L Bino Devi received the Sangeet Natak Akademi Award for which form of dance?

- Ans**
- 1. Kathakali
 - 2. Manipuri
 - 3. Ghoomar
 - 4. Sattriya

Q.32 In 1929, Bhagat Singh and an associate lobbed a bomb at the Central Legislative Assembly in Delhi to protest the implementation of which of the following Acts?

- Ans**
- 1. Vernacular Press Act
 - 2. Rowlatt Act
 - 3. Defence of India Act
 - 4. Child Marriage Restrain Act

Q.33 The Prime Minister of India dedicated _____ metro phase-I to the nation, in December 2022.

- Ans**
- 1. Jaipur
 - 2. Shimla
 - 3. Nagpur
 - 4. Amritsar

Q.34 'Left-arm leg spin' in cricket is known as _____.

- Ans**
- 1. off-spin
 - 2. orthodox spin
 - 3. leg spin
 - 4. Chinaman ball

Q.35 LPG is stored in small cylinders under a high pressure because:

- Ans**
- 1. it burns easily at room temperature
 - 2. liquid is lighter to carry
 - 3. the gas is turned into liquid form, thereby requiring less space for storage
 - 4. cylinders cannot store gas

Q.36 Where is the Mahabodhi temple, included in the list of UNESCO world heritagesites located?

- Ans**
- 1. Patna
 - 2. Deoria
 - 3. Bodh Gaya
 - 4. Kushinagar

Q.37 Who authored 'Untouchable' depicting the caste system?

- Ans**
- 1. Jai Ratan
 - 2. Vikram Seth
 - 3. RK Narayan
 - 4. Mulk Raj Anand

Q.38 In which state is Yubi Lakpi a traditional sport played?

- Ans
- 1. Jharkhand
 - 2. Himachal Pradesh
 - 3. Arunachal Pradesh
 - 4. Manipur

Q.39 Bharathi Vithal is primarily an award-winning _____ dancer.

- Ans
- 1. Bharatanatyam
 - 2. Mohiniyattam
 - 3. Kuchipudi
 - 4. Kathakali

Q.40 The Government of India flagship programme, 'Sarva Shiksha Abhiyan' is in fulfilment of which of the following provisions of the Directive Principles of State Policy?

- Ans
- 1. Article 45
 - 2. Article 42
 - 3. Article 43
 - 4. Article 44

Q.41 'Who moved my interest rate' is the autobiography of D Subbarao who was a _____.

- Ans
- 1. journalist
 - 2. businessman
 - 3. political leader
 - 4. banker

Q.42 An ancient Indian Sanskrit treatise on statecraft, political science, economic policy and military strategy, 'Arthashastra', was written by _____.

- Ans
- 1. Ashoka
 - 2. Bindusara
 - 3. Chandragupta Maurya
 - 4. Vishnugupta

Q.43 Which of the following is NOT a federal feature of the Indian Constitution?

- Ans
- 1. Independent judiciary
 - 2. Written constitution
 - 3. Single citizenship
 - 4. Division of powers between the Centre and the States

Q.44 In 1828, Brahma Samaj was established by whom among the following social reformers of British India?

- Ans
- 1. Baba Amte
 - 2. Jyotiba Phule
 - 3. Rabindranath Tagore
 - 4. Raja Ram Mohan Roy

Q.45 Which city hosted the 2023 SAFF Championship event?

- Ans
- 1. Bengaluru
 - 2. Mysore
 - 3. Mangalore
 - 4. Gulbarga

Q.46 In the year 1904, where was the first cement plant established in India?

- Ans
- 1. Kolkata
 - 2. Mumbai
 - 3. Chennai
 - 4. Delhi

Q.47 Madhu Mansuri Hasmukh is a singer, song writer and activist from the state of _____.

- Ans
- 1. Jharkhand
 - 2. Andhra Pradesh
 - 3. Chhattisgarh
 - 4. Madhya Pradesh

Q.48 In which year was the Bahmani kingdom established?

- Ans
- 1. 1336 CE
 - 2. 1347 CE
 - 3. 1351 CE
 - 4. 1325 CE

Q.49 The Sukreshwar Temple in Assam is a:

- Ans
- 1. Vishnu temple
 - 2. Krishna Temple
 - 3. Rama temple
 - 4. Shiva temple

Q.50 Originally, the Constitution of India contained _____ schedules.

- Ans
- 1. 7
 - 2. 10
 - 3. 8
 - 4. 6

Section : Reasoning

Q.1 Select the correct mirror image of the given figure when the mirror is placed at MN as shown below.



- Ans
- 1. $\nabla U O P E K$
 - 2. $\nabla U O P E K$
 - 3. $\nabla U O P E K$
 - 4. $\nabla U O P E K$

Q.2 Which of the following options will replace the question mark (?) in the given series?
323, 646, 969, 1292, ?

- Ans
- 1. 1200
 - 2. 1486
 - 3. 1615
 - 4. 1276

Q.3 Select the figure from the given options that will replace the question mark (?) in the figure given below to complete the pattern.

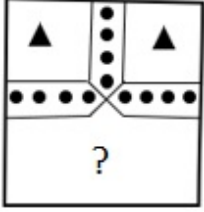

- Ans
- 1.
 - 2.
 - 3.
 - 4.

Q.4 Select the option that can replace the question mark (?) in the figure given below to complete the pattern.

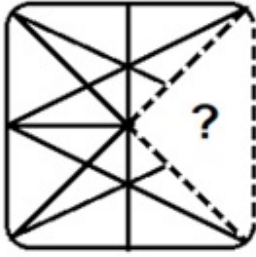

Ans

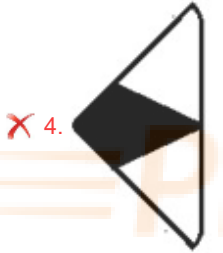
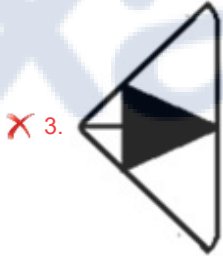
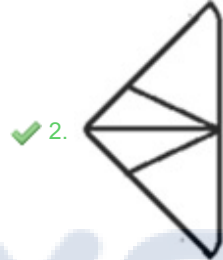
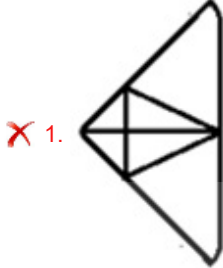

Q.5 Select the set in which the numbers are related in the same way as are the numbers of the following sets.
(NOTE: Operations should be performed on the whole numbers, without breaking down the numbers into its constituent digits. E.g. 13 – Operations on 13 such as adding/subtracting/multiplying etc. to 13 can be performed. Breaking down 13 into 1 and 3 and then performing mathematical operations on 1 and 3 is not allowed).
(6, 9, 2)
(12, 36, 2)

- Ans
- ✗ 1. (12, 6, 4)
 - ✓ 2. (18, 9, 6)
 - ✗ 3. (10, 8, 5)
 - ✗ 4. (14, 7, 7)

Q.6 Select the option that is related to the third word in the same way as the second word is related to the first word. (The words must be considered as meaningful English words and must not be related to each other based on the letters/number of consonants/vowels in the word)

Library : Catalogue :: Restaurant : ?

- Ans
- 1. Booklet
 - 2. Index
 - 3. Menu
 - 4. Recipe book

Q.7 A paper is folded and cut as shown below. How will it appear when unfolded?

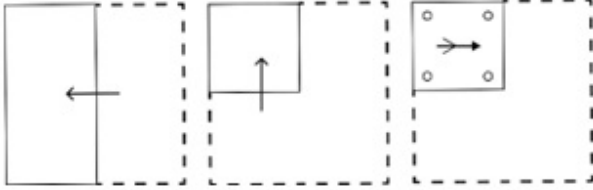

Ans

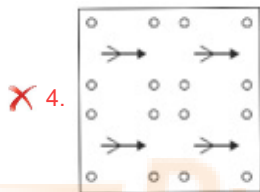
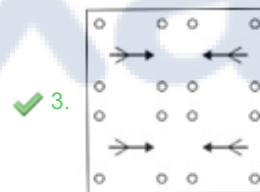
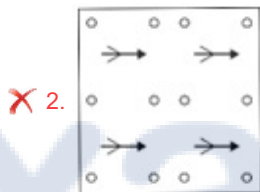
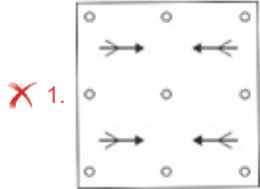

Q.8 Select the option figure that is embedded in the given figure. (Rotation is not allowed).

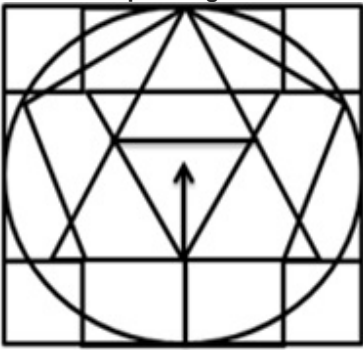

Ans

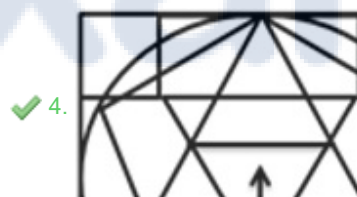
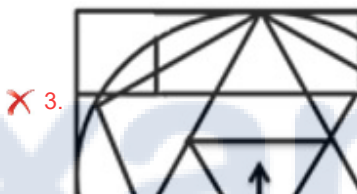
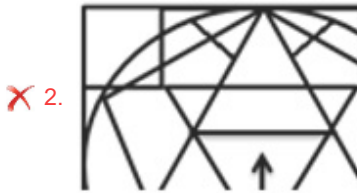
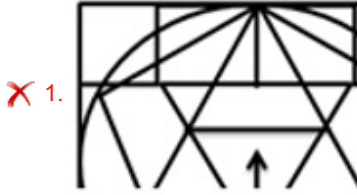

Q.9 In a certain code language, 'VALUE' is written as 'GWN CX' and 'PLANT' is written as 'VPCNR'. How will 'BRAIN' be written in that language?

- Ans
- ✗ 1. CTDPK
 - ✓ 2. PKCTD
 - ✗ 3. PKCDT
 - ✗ 4. PCKTD

Q.10 Which figure should replace the question mark (?) if the following series were to be continued?

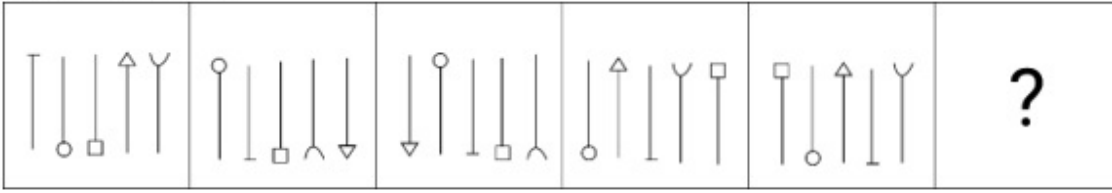

Ans

✗ 1.

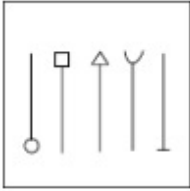

✓ 2.

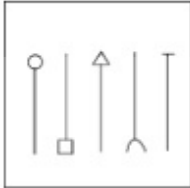

✗ 3.

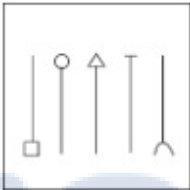

✗ 4.



Q.11 Which of the following option figures will complete the pattern in the figure given below?



Ans

✓ 1.



✗ 2.



✗ 3.



✗ 4.



Q.12 Which two signs should be interchanged to make the given equation correct?
 $658 \times 14 \div 3 - 32 + 56 = 165$

- Ans
- ✗ 1. \div and $+$
 - ✗ 2. \div and $=$
 - ✓ 3. \div and \times
 - ✗ 4. \div and $-$

Q.13 Select the correct mirror image of the given combination when the mirror is placed at line MN as shown.

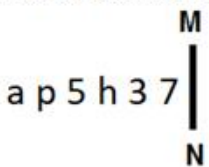

- Ans
- ✗ 1. 7 ε h 2 d a
 - ✗ 2. 7 ε 4 5 q 6
 - ✓ 3. 7 ε h 2 q 6
 - ✗ 4. 7 ε h 2 d 6

Q.14 Which two signs should be interchanged to make the following equation correct?

$$17 - 2 + 39 \div 3 \times 7 = 40$$

- Ans
- 1. + and ×
 - 2. - and ×
 - 3. ÷ and -
 - 4. - and +

Q.15 How many triangles are there in the given figure?

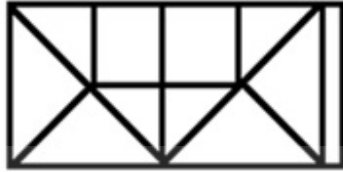

- Ans
- 1. 14
 - 2. 10
 - 3. 8
 - 4. 12

Q.16 Select the correct mirror image of the given combination when the mirror is placed at MN as shown.



- Ans
- 1. Я b ε θ c c f
 - 2. f c c θ ε b Я
 - 3. f c c θ b ε Я
 - 4. f c c θ c ε b Я

Q.17 Which of the following terms will replace the question mark (?) in the given series?
COL, FMO, IKR, ?, OGX

- Ans
- 1. LIU
 - 2. KJV
 - 3. KIV
 - 4. LIV

Q.18 Select the correct mirror image of the given figure when the mirror is placed at PQ as shown below.



- Ans
- ✓ 1. X U E 5 f 3 N
 - ✗ 2. X U E 2 f 3 N
 - ✗ 3. X U E 5 f 3 N
 - ✗ 4. X U E 2 f 3 N

Q.19 Six letters M, E, K, T, X and B are written on different faces of a dice. Two positions of this dice are shown in the figure. Find the letter on the face opposite to E.



- Ans
- ✗ 1. K
 - ✗ 2. M
 - ✗ 3. X
 - ✓ 4. T

Prepare 50% Faster

Q.20 Which figure should replace the question mark (?) if the following series were to be continued?

Q	8	W	W	C	Q	♡	Q	8	8	W	♡	C	♡	Q	
	C			7			W			7			8		?
7		♡	♡		8	7		C	C		Q	7		W	

Ans

✗ 1.

Q	♡	C
	7	
W		8

✗ 2.

Q	C	♡
	7	
W		8

✓ 3.

Q	8	C
	7	
W		♡

✗ 4.

C	8	Q
	7	
W		♡

Prepare 50% Faster

Q.21 A square sheet of paper is folded along the dotted line successively along the directions shown and is then punched last. How would the paper look when unfolded?

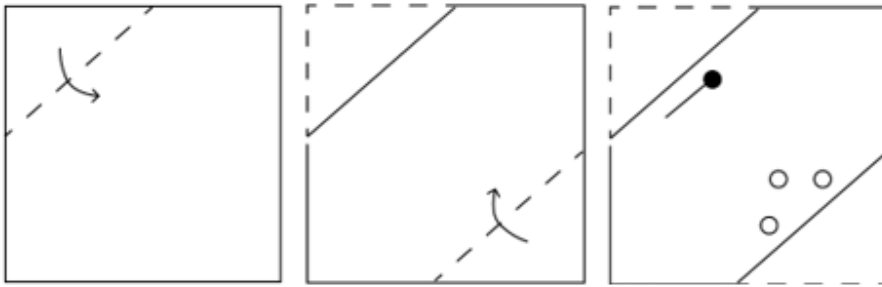

Ans

✓ 1.

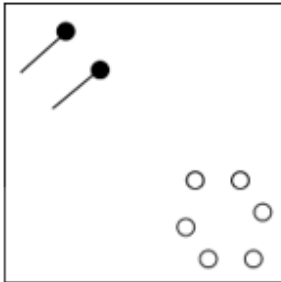

✗ 2.

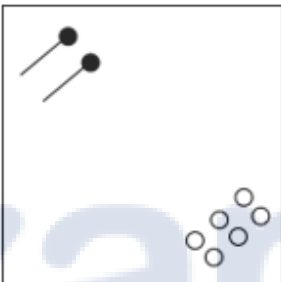

✗ 3.

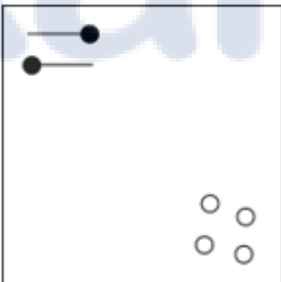

✗ 4.

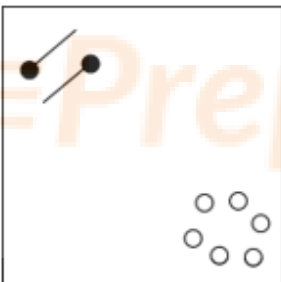

Q.22 Select the option that is related to the third term in the same way as the second term is related to the first term and the sixth term is related to the fifth term.
 $4 : 11 :: 8 : ? :: 12 : 35$

Ans ✗ 1. 31

✓ 2. 23

✗ 3. 15

✗ 4. 39

Q.23 Read the given statements and conclusions carefully. Assuming that the information given in the statements is true and it appears to be at variance with commonly known facts, decide which of the given conclusions logically follow(s) from the statements.

Statements:

- Some bottles are windows.
- Some windows are handles.
- All doors are handles.

Conclusions:

- I. Some bottles are handles.
- II. Some windows are bottles.
- III. Some doors are bottles.

- Ans**
- 1. Conclusions I, II and III follow
 - 2. Only conclusion II follows
 - 3. Conclusions I and II follow
 - 4. Conclusions I and III follow

Q.24 S, T, U, V and W are five sisters sitting in a straight line facing North. V sits second to the right of S. W sits second to the left of T. V sits at the extreme right end. Who sits at the exact centre of the line?

- Ans**
- 1. T
 - 2. S
 - 3. W
 - 4. U

Q.25 Which figure should replace the question mark (?) if the series were to be continued?

6	I	I	V	C	N	N	6	?
C	□	V	2	6	□	□	2	6
2	C	I	□	I	□	C	2	□

- Ans**
- 1.

□	S
2	I
C	N
 - 2.

□	S
C	2
N	I
 - 3.

6	□
2	I
C	N
 - 4.

6	S
C	2
N	I

Section : Numerical Ability

Q.1 Find the HCF of $3^2 \times 4^2 \times 9$, and $3^3 \times 4^4 \times 9^{10}$.

- Ans**
- 1. 1280
 - 2. 1296
 - 3. 1310
 - 4. 1290

Q.2 The HCF of 620 and 248 is:

- Ans
- 1. 126
 - 2. 124
 - 3. 132
 - 4. 128

Q.3 The lowest common multiple of 12, 36 and 80 is:

- Ans
- 1. 360
 - 2. 480
 - 3. 720
 - 4. 1440

Q.4 Shyam sells a notebook for ₹24 with the profit percentage equal to its cost price. How much did the notebook cost to Shyam?

- Ans
- 1. ₹24
 - 2. ₹20
 - 3. ₹18
 - 4. ₹16

Q.5 A hollow spherical vessel has external and internal radii of 10.5 cm and 7.7 cm respectively. What is the mass (in kg, rounded off to the nearest tens) of the sphere if it is made of metal of density 10.3 g/cm^3 ?

(Take $\pi = \frac{22}{7}$)

- Ans
- 1. 32
 - 2. 25
 - 3. 30
 - 4. 28

Q.6 A certain sum of money at a certain rate of simple interest becomes ₹4,620 after two years, and at the same rate after two and a half years becomes ₹4,725. Find the rate per cent per annum.

- Ans
- 1. 4%
 - 2. 3%
 - 3. 5%
 - 4. 6%

Q.7 The area of the base of a right circular cone is $25\pi \text{ cm}^2$ and its height is 12 cm. What is the curved surface area (in cm^2) of the cone?

- Ans
- 1. 73π
 - 2. 65π
 - 3. 83π
 - 4. 67π

Q.8 What is the mean proportional of 16.81 and 12.96?

- Ans
- 1. 18.36
 - 2. 21.52
 - 3. 14.76
 - 4. 16.48

Q.9 A and B together can complete a work in 24 days, while B alone can complete it in 48 days. A alone can finish the

- Ans
- 1. 42 days
 - 2. 48 days
 - 3. 36 days
 - 4. 58 days

Q.10 A sum of ₹5,19,500 was borrowed at $7\frac{4}{5}\%$ per annum compound interest and paid back in 2 years in two equal annual instalments. What is the instalment?

- Ans
- 1. ₹2,90,521
 - 2. ₹2,70,521
 - 3. ₹2,80,521
 - 4. ₹3,00,521

Q.11 From two places, 88 km apart, Akash and Vikas start towards each other at the same time and meet each other after 8 hours. If Akash travelled at $\frac{7}{6}$ of his speed and Vikas travelled at triple of his speed, they would have met after 4 hours. The speed of Vikas is:

- Ans
- 1. 6 km/h
 - 2. 5 km/h
 - 3. 7 km/h
 - 4. 4 km/h

Q.12 If 60% of X = 40% of Y, then X : Y = ?

- Ans
- 1. 3 : 2
 - 2. 3 : 5
 - 3. 2 : 3
 - 4. 2 : 5

Q.13 A town has a population of 7,000. If the percentage increase in the male and female population is 11% and 8%, respectively, the new population will be 7,680. Find the number of female citizens in the town.

- Ans
- 1. 2500
 - 2. 4000
 - 3. 4500
 - 4. 3000

Q.14 The average weight of a class of 15 students is 30 kg. A new student joins and the average weight rises by 1 kg. Find the weight (in kg) of the new student.

- Ans
- 1. 46
 - 2. 40
 - 3. 42
 - 4. 45

Q.15 A vendor gives a trade discount of 10% and 20% on the purchase of an article whose marked price is ₹500. Another vendor gives 30% discount on the same article. What is the difference between their selling prices (in ₹)?

- Ans
- 1. 10
 - 2. 11
 - 3. 12
 - 4. 15

Q.1 In MS Excel 365, which of the following is the shortcut key in MS Excel to open a spreadsheet that is already exists

- Ans**
- 1. Alt + N
 - 2. Ctrl + O
 - 3. Ctrl + N
 - 4. Alt + O

Q.2 What is the purpose of attaching files to an email?

- Ans**
- 1. To add decorative elements to the email
 - 2. To share documents, images or other files with the recipient
 - 3. To increase the size of the email
 - 4. To format the email text

Q.3 In MS Excel 365, the shortcut key to open the custom sort is:

- Ans**
- 1. Shift + A + S
 - 2. Ctrl + A + S
 - 3. Windows Key + A + S
 - 4. Alt + A + S

Q.4 In MS Word 365 how can you select a paragraph in Microsoft Word?

- Ans**
- 1. Triple-click anywhere within the paragraph.
 - 2. Right-click anywhere within the paragraph and choose 'Select Paragraph'.
 - 3. Press Ctrl+B to select the entire paragraph.
 - 4. Double-click anywhere within the paragraph.

Q.5 Bullets and numbering are commonly used in Microsoft Word 365 to:

- Ans**
- 1. add borders around paragraphs
 - 2. format text as headings
 - 3. create lists for better organisation
 - 4. italicise the text

Q.6 In MS Excel 365, By default, the spreadsheet will be saved in which of the following formats?

- Ans**
- 1. .docx
 - 2. .xlxs
 - 3. .xlsx
 - 4. .doc

Q.7 In Microsoft Word 365, how can we apply different page formatting within the same document by separating areas with different formats?

- Ans**
- 1. By Section Break
 - 2. By Insert
 - 3. By Page Layout
 - 4. By Page Break

Q.8 Which of the following is the function of an IP address?

- Ans**
- 1. Creating secure connections
 - 2. Identifying devices on a network
 - 3. Managing email communication
 - 4. Formatting web pages

Q.9 Which of the following groups in the Home tab of MS word 365, consists of Bullets and Numbering?

- Ans
- 1. Clipboard
 - 2. Font
 - 3. Editing
 - 4. Paragraph

Q.10 Which of the following bars provides a shortcut to menu commands which are represented in the form of icons?

- Ans
- 1. Menu bar
 - 2. Tool Bar
 - 3. Space Bar
 - 4. Vertical Bar



Prepare 50% Faster

Constable Executive Male and Female in Delhi Police Examination 2023

Exam Date	21/11/2023
Exam Time	12:00 PM - 1:30 PM
Subject	Constable Executive Male and Female in Delhi Police Examination 2023

Section : General Knowledge

Q.1 Which of the following was added in the Constitution of India in 1976?

- Ans**
- 1. Fundamental duty
 - 2. Directive principle
 - 3. Fundamental rights
 - 4. Right to education

Q.2 Who among the following Mughal emperors was taken as the leader by the sepoy and led the revolt of 1857?

- Ans**
- 1. Shah Jahan II
 - 2. Muhammad Shah
 - 3. Bahadur Shah Zafar
 - 4. Aurangzeb

Q.3 Where is the oldest branch of the Ramakrishna Mission in the United States located?

- Ans**
- 1. Chicago
 - 2. New York
 - 3. Atlanta
 - 4. Texas

Q.4 In which of the following years was the Bandhan Financial Services Private Limited set up to alleviate poverty and women empowerment?

- Ans**
- 1. 2002
 - 2. 2001
 - 3. 2003
 - 4. 2004

Q.5 KV Prasad and SV Rajarao are both associated with which of the following percussion instruments?

- Ans**
- 1. Kanjira
 - 2. Tabla
 - 3. Ghatam
 - 4. Mridangam

Q.6 Which of the following statements is correct?

- Ans**
- 1. Energy flow in the ecosystem is unidirectional.
 - 2. All ecosystems are constant in size.
 - 3. In nature, only food chains exist but not the food web.
 - 4. The pyramid of energy is always inverted.

Q.7 Consider following statements.
 1)A system consisting of biotic and abiotic components is known as ecosystem. .
 2)All the components of the ecosystem are inter-related.
 3)Ecosystem always have clear boundaries.
 Which statement is/are correct?

- Ans**
- 1. All the statements are correct.
 - 2. Both 1 and 3 statements are correct.
 - 3. Both 2 and 3 statements are correct.
 - 4. Both 1 and 2 statements are correct.

Q.8 Which of the following is NOT a factor that causes rainfall in India?

- Ans**
- 1. Convention
 - 2. Anti-cyclone
 - 3. Cyclone
 - 4. Orography

Q.9 What is the full form of HYV seeds that were essential in the implementation of the green revolution?

- Ans**
- 1. High Yielding Variety seeds
 - 2. Hand Yielding Volume seeds
 - 3. High Yielding Volume seeds
 - 4. High Yeast Variety seeds

Q.10 What is a relatively small, triangular-shaped minor oceanic plate located beneath the Pacific Ocean off the west coast of Central America?

- Ans**
- 1. Okhotsk plate
 - 2. Nazca plate
 - 3. Sunda plate
 - 4. Cocos plate

Q.11 In which year was 'Pradhan Mantri Rozgar Yojana' ('PMRY') launched?

- Ans**
- 1. 2001
 - 2. 1993
 - 3. 1999
 - 4. 1990

Q.12 Where was the first unit of the Singh Sabha formed in 1873?

- Ans**
- 1. Amritsar
 - 2. Patiala
 - 3. Chandigarh
 - 4. Karachi

Q.13 As per Tendulkar Expert Group (2009), for the year 2011-2012, the national poverty line in India for a person was fixed at _____ per month for the urban areas.

- Ans**
- 1. ₹1,500
 - 2. ₹2,000
 - 3. ₹800
 - 4. ₹1,000

Q.14 Sangeet Natak Akademi award winner Guru Vempati Chinna Satyam was an exponent of _____ .

- Ans**
- 1. Kathakali
 - 2. Kuchipudi
 - 3. Bharatanatyam
 - 4. Mohiniyattam

Q.15 Chaitya Hall of Maharashtra is an example of _____ .

- Ans
- 1. Nagara architecture
 - 2. Islamic architecture
 - 3. Cave architecture
 - 4. Dravidian architecture

Q.16 What were cash crops such as cotton and sugarcane called during the Mughal period?

- Ans
- 1. Jins-i-taqh
 - 2. Jins-i-qiblis
 - 3. Jins-i-kamil
 - 4. Jins-i-shukr

Q.17 Who among the following female leaders addressed the Indian National Congress session of 1890?

- Ans
- 1. Vina Mazumdar
 - 2. Kadambini Ganguli
 - 3. Nanibala Devi
 - 4. Basanti Devi

Q.18 According to Census of India 2011, select the state that had less than 10 crore population?

- Ans
- 1. Uttar Pradesh
 - 2. Bihar
 - 3. Maharashtra
 - 4. West Bengal

Q.19 Vilayat Khan is known for playing which of the following instruments?

- Ans
- 1. Sarod
 - 2. Sitar
 - 3. Violin
 - 4. Santoor

Q.20 What is the required size of the Olympic swimming pool?

- Ans
- 1. 25 m × 15 m
 - 2. 50 m × 25 m
 - 3. 60 m × 60 m
 - 4. 50 m × 30 m

Q.21 Which of the following sports persons is associated with Billiards?

- Ans
- 1. Pushpendra Kumar Garg
 - 2. Nameirakpam Kunjarani
 - 3. Homi Motiwala
 - 4. Geet Sethi

Q.22 Biome can be defined as:

- Ans
- 1. a large area characterised by its vegetation, soil, climate, and wildlife
 - 2. a restricted area where only selected species can grow
 - 3. an area of desert
 - 4. an aquatic environment where only fishes can grow

Q.23 Who among the following was NOT a member of the All India Khilafat Committee, formed by Ali brothers in early

- Ans**
- 1. Hasrat Mohani
 - 2. Yakub Hasan Sait
 - 3. Maulana Abul Kalam Azad
 - 4. Hakim Ajmal Khan

Q.24 As a result of double counting, National Income is:

- Ans**
- 1. over-estimated
 - 2. under-estimated
 - 3. not estimated for the entire year of accounting
 - 4. correctly estimated

Q.25 Who can amend any part of the Constitution without affecting the 'basic structure' of the Constitution?

- Ans**
- 1. Judiciary
 - 2. Executive
 - 3. President
 - 4. Parliament

Q.26 Which of the following cultural festivals is celebrated by the tribal people of Jharkhand?

- Ans**
- 1. Ugadi
 - 2. Sao Joao
 - 3. Hareli
 - 4. Sohrai

Q.27 The first Khelo India Winter Games was hosted by which of the following places?

- Ans**
- 1. Leh
 - 2. Ladakh
 - 3. Shimla
 - 4. Gulmarg

Q.28 Mrinalini Sarabhai is associated with which of these dance forms?

- Ans**
- 1. Kathakali
 - 2. Kathak
 - 3. Mohiniyattam
 - 4. Manipuri

Q.29 What is the name of the scheme which has been rechristened in the year 2018 as Poshan Abhiyaan?

- Ans**
- 1. National Nutrition Mission
 - 2. Deen Dayal Upadhyaya Antyodaya
 - 3. Integrated Child Development Scheme
 - 4. National Mid-Day Meal Scheme

Q.30 Which of the following statements are correct regarding Fundamental Rights of the Indian Citizen?
A. Some of the Fundamental Rights are available against the arbitrary action of the state, some of them available private people.
B. Fundamental Rights are not absolute but qualified.
C. The Parliament can curtail or repeal the Fundamental Rights but without affecting the basic structure of the Indian Constitution.
D. Under Fundamental Rights, the aggrieved person cannot go to the Supreme Court directly, but they can go to the High Court directly.

- Ans**
- 1. A, B and C only
 - 2. B, C and D only
 - 3. A, B, C and D
 - 4. A, C and D only

Q.31 Which of the following is a Private Sector Undertaking of India?

- Ans**
- 1. Bengal Chemicals and Pharmaceuticals Limited
 - 2. Bhadravati Steel Plant
 - 3. Housing Development Finance Corporation Limited
 - 4. Alloy Steels Plant

Q.32 Vijay Stambh was built by which of these rulers?

- Ans**
- 1. Durga Das Rathore
 - 2. Maharana Pratap
 - 3. Prithvi Raj Chauhan
 - 4. Rana Kumbha

Q.33 Which Article of the Constitution of India deals with the ordinance making power of the Governor?

- Ans**
- 1. Article 203
 - 2. Article 205
 - 3. Article 213
 - 4. Article 209

Q.34 Isobars are defined as:

- Ans**
- 1. atoms of the same element having the same atomic number but different mass numbers
 - 2. atoms of different elements having the same mass number but different atomic numbers
 - 3. atoms of the same element having different atomic numbers and different proton numbers
 - 4. atoms of the same element having the same neutron number but different atomic numbers

Q.35 What types of proteins reside within the bilayer membrane that surrounds cells and organelles, and play an important role in the movement of molecules across them and the transmission of energy and signals?

- Ans**
- 1. Glycoproteins
 - 2. Carrier proteins
 - 3. Peripheral membrane proteins
 - 4. Integral membrane proteins

Q.36 'The Great Gatsby' is an English novel written by which of the following authors?

- Ans**
- 1. Ernest Hemingway
 - 2. D. H. Lawrence
 - 3. F. Scott Fitzgerald
 - 4. Oscar Wilde

Q.37 The IISCO and TISCO industrial plants are related to which industry?

- Ans
- 1. Sugar
 - 2. Textile
 - 3. Iron and steel
 - 4. Cement

Q.38 Which of the following is NOT a quality/feature of the parliamentary form of government?

- Ans
- 1. Harmony between legislature and executive
 - 2. Collective responsibility
 - 3. Wide representation
 - 4. Single executive

Q.39 In the context of financing five-year plans, which of the following is NOT one of the sources of finance available to the private sector as against the public sector?

- Ans
- 1. Public sector financial institutions
 - 2. Savings of individuals
 - 3. Taxes
 - 4. Foreign funds in the form of equity capital

Q.40 Who among the following novelists wrote 'Midnight's Children'?

- Ans
- 1. Vikram Seth
 - 2. Shashi Tharoor
 - 3. Salman Rushdie
 - 4. VS Naipaul

Q.41 Member of Rajya Sabha, Sonal Mansingh is an eminent dancer of _____ and Bharatanatyam.

- Ans
- 1. Kathakali
 - 2. Odissi
 - 3. Mohiniyattam
 - 4. Kathak

Q.42 The Sangeet Natak Akademi gives fellowships to eminent artists. Sonal Mansingh received it for Odissi which is a dance form of which State?

- Ans
- 1. Kerala
 - 2. Andhra Pradesh
 - 3. Odisha
 - 4. Uttar Pradesh

Q.43 Which of the following Directive Principles of State Policy of the Indian Constitution falls under socialistic principles?

- Ans
- 1. Equal pay for equal work for men and women
 - 2. To prohibit the consumption of intoxicating drinks and drugs
 - 3. To promote functioning of co-operative societies
 - 4. To protect and improve the environment and to safeguard forests and wildlife

Q.44 Which of the following Buddhist texts is based on the conversation between the Buddhist sage Nagasena and Indo Greek king Menander?

- Ans
- 1. Prajnaparamita
 - 2. Dhammapada
 - 3. Milindapanha
 - 4. Mahavamsa

Q.45 According to India Brand Equity Foundation report (2020-21), which group of states of India is the largest coffee |

- Ans
- 1. Kerala and Andhra Pradesh
 - 2. Tamil Nadu and Kerala
 - 3. Karnataka and Tamil Nadu
 - 4. Karnataka and Kerala

Q.46 'Nation First, Always First' is the theme of _____ Independence Day 2022.

- Ans
- 1. 72nd
 - 2. 77th
 - 3. 70th
 - 4. 75th

Q.47 Rudradaman belonged to which of the following dynasties?

- Ans
- 1. Maurya
 - 2. Gupta
 - 3. Kushana
 - 4. Shaka

Q.48 Shree Hanuman Vyayam Prasarak Mandal is situated in _____.

- Ans
- 1. Amravati
 - 2. New Delhi
 - 3. Mumbai
 - 4. Nagpur

Q.49 'Higher Education Leadership Development Programme for Administrator' is a programme launched by which Union Ministry?

- Ans
- 1. Ministry of Corporate Affairs
 - 2. Ministry of Human Resource Development
 - 3. Ministry of MSME
 - 4. Ministry of Skill Development and Entrepreneurship

Q.50 With which of the following subjects are Article 123 and Article 213 of the Constitution of India associated?

- Ans
- 1. Annual financial statement
 - 2. Jurisdiction of Courts
 - 3. Issuing writs
 - 4. Ordinance-making power

Section : Reasoning

Q.1 In a certain code language, 'BABY' is written as '43427' and 'CREW' is written as '520725'. How will 'DATE' be written in that language?

- Ans
- 1. 63227
 - 2. 41205
 - 3. 62206
 - 4. 53215

Q.2 Select the number from among the given options that can replace the question mark (?) in the following series.
21, 30, 23, 32, 25, ?

- Ans
- 1. 37
 - 2. 36
 - 3. 34
 - 4. 38

Q.3 Which figure should replace the question mark (?) if the following series were to be continued?

B	O	Z	T	B	Z	L	T	B	L	
	L		O		D		Z		S	?
Z		T	B	L	T	B	D	D	T	

Ans

✗ 1.

D	B
	S
T	L

✓ 2.

D	T
	L
B	S

✗ 3.

D	T
	B
S	L

✗ 4.

D	S
	T
B	L

Q.4 Select the option that is related to the fifth letter cluster in the same way as the second letter cluster is related to the first letter cluster and the fourth letter cluster is related to the third letter cluster.
PENG : LIJK :: MONG : ISJK :: FTCH : ?

Ans ✓ 1. BXYL

✗ 2. AIEB

✗ 3. JKRI

✗ 4. VDAG

Q.5 Select the set in which the numbers are NOT related in the same way as are the numbers of the following sets.

(192, 12, 10), (195, 15, 7)

(NOTE: Operations should be performed on the whole numbers, without breaking down the numbers into its constituent digits.)

Ans ✓ 1. (208, 13, 16)

✗ 2. (228, 12, 13)

✗ 3. (128, 8, 10)

✗ 4. (189, 9, 15)

Q.6 Which of the following terms will replace the question mark (?) in the given series?
CJLR, DINP, ?, FGRL, GFTJ

Ans ✗ 1. EHON

✗ 2. EIPN

✗ 3. EJPO

✓ 4. EHPN

Q.7 Select the option in which the given figure is embedded (rotation is NOT allowed).

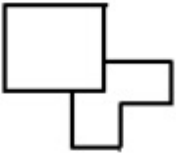

Ans

✗ 1.

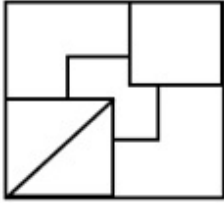

✓ 2.

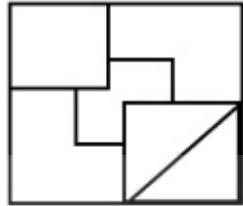

✗ 3.

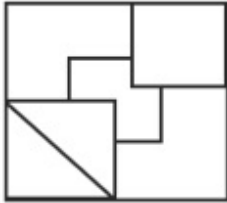

✗ 4.

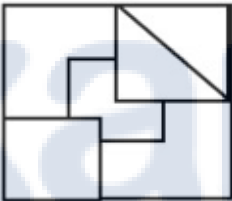

Q.8 J, K, L, M, N and O are sitting around a circular table facing the centre. Only two people sit between J and O. Only one person sits between O and N. Only two people sit between N and M. K sits to the immediate right of N. Who is sitting to the immediate left of L?

Ans ✓ 1. M

✗ 2. O

✗ 3. K

✗ 4. N

Prepare 50% Faster

Q.9 Select the correct mirror image of the given figure when the mirror is placed at 'AB' as shown.

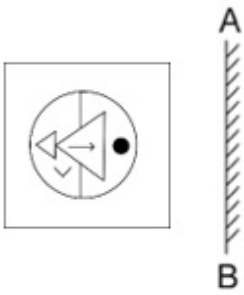

Ans

X 1.

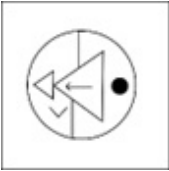

✓ 2.



X 3.



X 4.

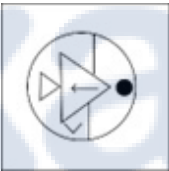

Prepare 50% Faster

Q.10 A square sheet of paper is folded along the dotted line successively along the directions shown and is then punched last. How would the paper look when unfolded?

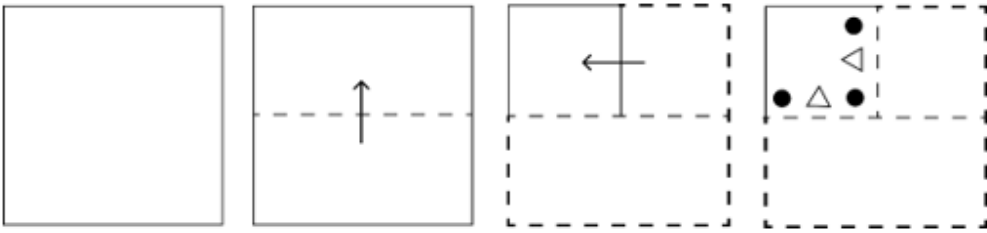

Ans

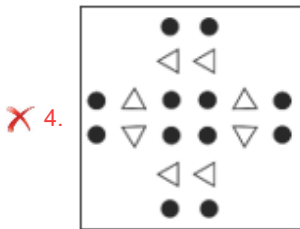
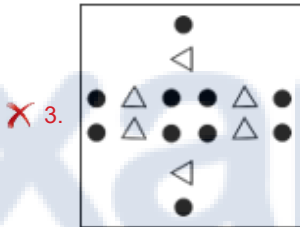
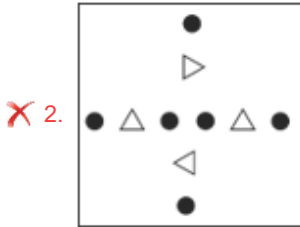
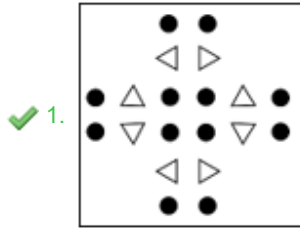

Q.11 Select the correct combination of mathematical signs that can sequentially replace the * signs and balance the given equation.

$$17 * 3 * 6 * 45$$

Ans ✗ 1. -, =, +

✗ 2. ÷, -, =

✓ 3. ×, -, =

✗ 4. ×, ÷, =

Q.12 Select the option figure that is embedded in the given figure. (Rotation is not allowed).

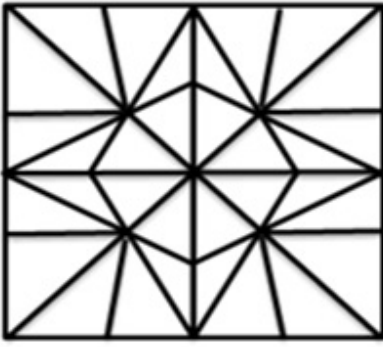

Ans

1.



2.



3.



4.



Q.13 If 'A' denotes '+', 'B' denotes 'x', 'C' denotes '-' and 'D' denotes '÷', then what will come in place of '?' in the following equation?
(35 A 7 B 2) D 7 C (14 D 2 C 6) A 6 = ?

Ans

1. 15

2. 1

3. 0

4. 12

Prepare 50% Faster

Q.14 Which of the following option figures will complete the pattern in the figure given below?



Ans

X 1.



X 2.



✓ 3.



X 4.



Prepare 50% Faster

Q.15 Which figure should replace the question mark (?) if the following series were to be continued?

V	X	9	V	V	↑	2	V	V	X						
↑	2	9	2	↑	X	X	9	2	9	X	↑	↑	2	9	?

Ans

1.

X	2
9	V
↑	

2.

9	V
2	↑
X	

3.

↑	V
2	9
X	

4.

X	9
V	↑
2	

Q.16 How many triangles are there in the given figure?



Ans

1. 10

2. 6

3. 9

4. 8

Q.17 Select the figure from the options that can replace the question mark (?) and complete the given pattern.

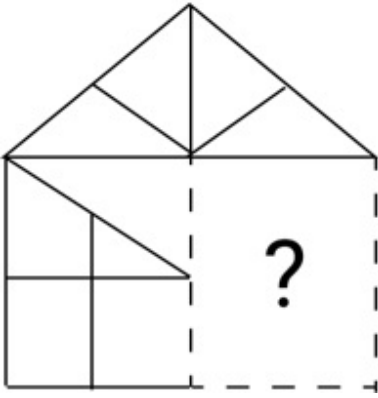

Ans

X 1.

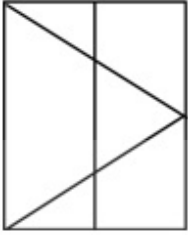

X 2.

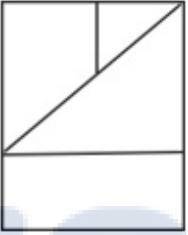

✓ 3.

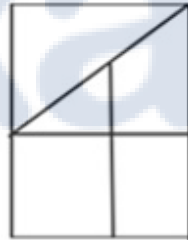

X 4.

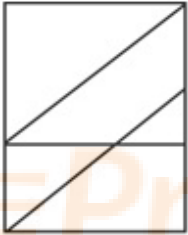

Q.18

Select the option in which given figure is embedded. (Rotation is not allowed.)



Ans

✓ 1.

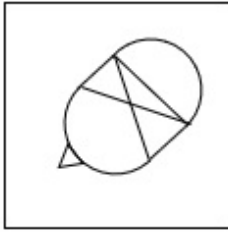

✗ 2.



✗ 3.

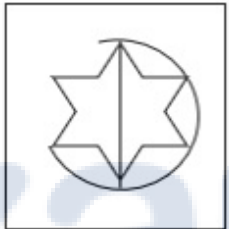

✗ 4.

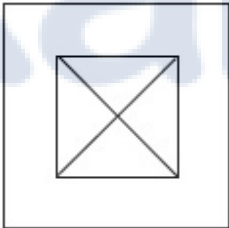

Q.19

Select the figure that will replace the question mark (?) in the following figure series.



Ans

✓ 1.



✗ 2.



✗ 3.



✗ 4.



Q.20 Select the figure from the given options that will replace the question mark (?) in the figure given below to complete the pattern so that the final image is symmetrical.

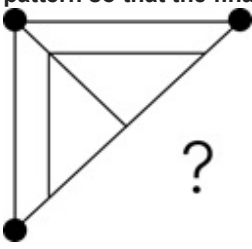

Ans

✓ 1.

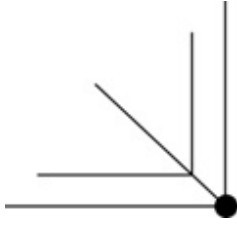

✗ 2.

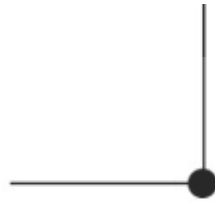

✗ 3.

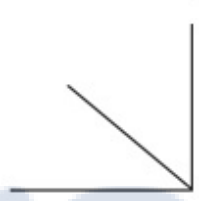

✗ 4.

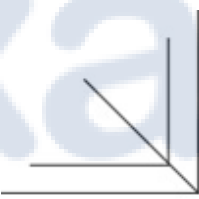

Q.21 Six letters, M, N, O, P, Q and R are written on different faces of a dice. Three positions of this dice are shown here. Find the letter on the face opposite M.



Ans ✗ 1. Q

✗ 2. N

✗ 3. R

✓ 4. O

Q.22 Select the figure from the given options that will replace the question mark (?) in the figure given below to complete the pattern so that the final image is symmetrical.

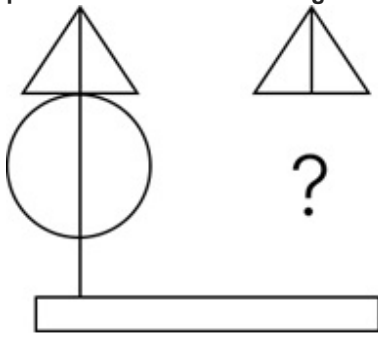

Ans

- 1.
- 2.
- 3.
- 4.

Q.23 Six numbers 1, 2, 3, 4, 5 and 6 are written on different faces of a dice. Two positions of this dice are shown in the figure. Find the number on the face opposite to 3.

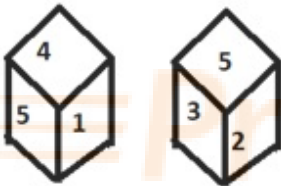

- Ans
- 1. 4
 - 2. 6
 - 3. 1
 - 4. 2

Q.24 Two statements are given followed by two conclusions numbered I and II. Assuming the statements to be true, even if they seem to be at variance from commonly known facts, decide which of the conclusions logically follow(s) from the statements.

Statements:

Some Fans are Round.

Some Round are Circles.

Conclusions:

I. All Fans are Circles.

II. All Circles are Round.

- Ans
- 1. Both conclusions I and II follow.
 - 2. Only conclusion I follows.
 - 3. Only conclusion II follows.

4. Neither conclusion I nor II follows.

Q.25 Select the option that is related to the third term in the same way as the second term is related to the first term as term is related to the fifth term.
4 : 12 :: 8 : ? :: 10 : 24

- Ans
- 1. 24
 - 2. 22
 - 3. 20
 - 4. 16

Section : Numerical Ability

Q.1 A sum on compound interest at a certain rate becomes ₹9,680 in 2 years and ₹11,712.80 in 4 years. What is the rate of interest?

- Ans
- 1. 10%
 - 2. 30%
 - 3. 40%
 - 4. 20%

Q.2 What is the cost (in ₹) required to paint a basketball having a diameter of 14 cm, if the painting cost of the basketball is ₹2.5/cm²? (take $\pi = \frac{22}{7}$)

- Ans
- 1. 6160
 - 2. 3593
 - 3. 1540
 - 4. 385

Q.3 If the simple interest on ₹800 for 4 years and on ₹600 for 2 years combined together is ₹280, then what is the rate of interest per annum?

- Ans
- 1. $6\frac{4}{11}\%$
 - 2. $7\frac{3}{11}\%$
 - 3. $3\frac{3}{11}\%$
 - 4. $5\frac{3}{11}\%$

Q.4 In a race of 150 m, R beats S by 9 m. If S takes a head start of 15 m, how long (in m) should the race be to have a tie between them?

- Ans
- 1. 250
 - 2. 210
 - 3. 180
 - 4. 270

Q.5 In the descending order arrangement of the given terms, which term will come exactly in the

$$\frac{7}{8}, \frac{6}{7}, \frac{11}{13}, \frac{17}{20}, \frac{23}{25}$$

Ans

✓ 1. $\frac{6}{7}$

✗ 2. $\frac{11}{13}$

✗ 3. $\frac{17}{20}$

✗ 4. $\frac{7}{8}$

Q.6 The marked price of a chair was ₹1,200. This price was 20% above its cost price. If the chair was sold at a discount of 5% on the marked price, then find the profit percentage.

Ans

✗ 1. 11%

✗ 2. 12%

✗ 3. 16%

✓ 4. 14%

Q.7 What is the largest number that can exactly divide 48, 92 and 140?

Ans

✗ 1. 11

✓ 2. 4

✗ 3. 14

✗ 4. 12

Q.8 Find the average of all the odd numbers from 1 to 43.

Ans

✗ 1. 21

✗ 2. 25

✓ 3. 22

✗ 4. 23

Q.9 A and B working separately can mow a field in 12 and 10 hours, respectively. They work alternately, each for 1 hour, beginning with A, at 5:00 a.m. At what time will the mowing be completed?

Ans

✓ 1. 4:00 p.m.

✗ 2. 5:00 p.m.

✗ 3. 5:30 p.m.

✗ 4. 4:30 p.m.

Q.10 If David purchases 10 bananas for ₹25 and sells 9 bananas for ₹45, then what is the gain percentage?

Ans

✓ 1. 100%

✗ 2. 60%

✗ 3. 65%

✗ 4. 87%

Q.11 What is the area (in cm^2) of a triangle whose sides are 3 cm, 4 cm, and 5 cm?

Ans

✗ 1. 10.5

✓ 2. 6

✗ 3. 4

✗ 4. 8

Q.12 The HCF of 448 and 336 is _____ times the HCF of 48 and 36.

- Ans
- 1. $\frac{28}{3}$
 - 2. $\frac{31}{3}$
 - 3. $\frac{29}{3}$
 - 4. 9

Q.13 If the radius of the base of a right circular cylinder is increased by 20% and the height is decreased by 30%, then what is the percentage increase/decrease in the volume?

- Ans
- 1. Decrease by 0.5%
 - 2. Decrease by 0.8%
 - 3. Increase by 0.5%
 - 4. Increase by 0.8%

Q.14 The sum of the digits of the LCM of the numbers 30, 48, 96, 150 is:

- Ans
- 1. 12
 - 2. 6
 - 3. 8
 - 4. 14

Q.15 A salesman earns a 2% of return on $\frac{1}{4}$ of his capital, 4% on $\frac{1}{2}$ of capital and 10% on the remaining. Find the average rate of return he earned on his capital.

- Ans
- 1. 15%
 - 2. 20%
 - 3. 10%
 - 4. 5%

Section : Computer Proficiency

Q.1 What is the purpose of a URL (Uniform Resource Locator)?

- Ans
- 1. To provide the address of a web resource
 - 2. To create animations on websites
 - 3. To format text on websites
 - 4. To manage user accounts on websites

Q.2 In MS Excel 365 which of the following shortcut keys is used to select entire workbook in MS Excel?

- Ans
- 1. Ctrl + S
 - 2. F1
 - 3. Ctrl + A
 - 4. F6

Q.3 In MS Excel 365 which tab on the Microsoft Excel ribbon allows you to access options related to opening and saving files?

- Ans
- 1. Home
 - 2. Insert
 - 3. File
 - 4. View

Q.4 The keyboard shortcut key used to print preview in MS-Word 365 is:

- Ans**
- 1. Ctrl + F1
 - 2. Shift + F2
 - 3. Shift + F1
 - 4. Ctrl + F2

Q.5 In MS Excel 365 which of the following is one of the options to edit cells in MS-Excel?

- Ans**
- 1. Formula bar
 - 2. Edit bar
 - 3. Ribbon
 - 4. Space bar

Q.6 In most word processors, which of the following keyboard shortcuts is used to bold, italicize, and underline the text, respectively?

- Ans**
- 1. Ctrl + B, Ctrl + I, Ctrl + U
 - 2. Ctrl + P, Ctrl + V, Ctrl + U
 - 3. Ctrl + B, Ctrl + X, Ctrl + V
 - 4. Ctrl + A, Ctrl + B, Ctrl + C

Q.7 Which of the following statements related to Assigning a Label to an email is INCORRECT?

- Ans**
- 1. We cannot use label in email to sort our inbox.
 - 2. We can use labels in email to sort our inbox.
 - 3. Assigning a label to an email is the equivalent of moving it into a specific folder.
 - 4. We can apply multiple labels to a single email.

Q.8 Which of the following options is used while printing documents in MS Word 365, i.e. if we want to print all the pages from 7 till 10, then the printer should print only the 7th, 8th, 9th and 10th pages?

- Ans**
- 1. Print one sided
 - 2. Collated
 - 3. Print Custom Range
 - 4. Orientation

Q.9 In MS-Word 365, which of the following actions is a part of the document creation process?

- Ans**
- 1. Inserting a table of contents
 - 2. Printing the document
 - 3. Saving the document with a new name
 - 4. Applying formatting to the text

Q.10 Which option allows you to increase the size of selected text in Microsoft Word 365?

- Ans**
- 1. Underline
 - 2. Bold
 - 3. Italic
 - 4. Font Size

Constable Executive Male and Female in Delhi Police Examination 2023

Exam Date	21/11/2023
Exam Time	3:00 PM - 4:30 PM
Subject	Constable Executive Male and Female in Delhi Police Examination 2023

Section : General Knowledge

Q.1 With reference to electric charges, identify the INCORRECT statement.

- Ans**
- 1. Like charges repel and unlike charges attract each other.
 - 2. The electrical charges produced by rubbing are called static charges.
 - 3. Lightning conductor can protect a building from lightning.
 - 4. Lightning conductor can be used to predict lightning strike.

Q.2 When did Dipa Karmakar win the Major Dhyan Chand Khel Ratna Award in Gymnastics?

- Ans**
- 1. 2018
 - 2. 2016
 - 3. 2015
 - 4. 2017

Q.3 Chandertal, Renuka and Pong Dam are the three Ramsar wetland sites of which state?

- Ans**
- 1. Himachal Pradesh
 - 2. Karnataka
 - 3. Gujarat
 - 4. Assam

Q.4 Article 32 of the Constitution of India deals with _____ .

- Ans**
- 1. the Right to Freedom
 - 2. Cultural and Educational Rights
 - 3. the Right to Constitutional Remedies
 - 4. the Right to Freedom and Religion

Q.5 Kelucharan Mohapatra has been awarded the Padma Bhushan for which form of classical dance?

- Ans**
- 1. Bharatanatyam
 - 2. Kathak
 - 3. Kuchipudi
 - 4. Odissi

Q.6 In which of the following Articles of India is it mentioned that "it shall be the duty of every citizen of India to cherish and follow the noble ideals which inspired our national struggle for freedom"?

- Ans**
- 1. 51A (f)
 - 2. 51A (a)
 - 3. 51A (i)
 - 4. 51A (b)

Q.7 The city of Hampi was named after the local mother goddess called _____ .

- Ans
- 1. Hampidevi
 - 2. Pampadevi
 - 3. Hampini
 - 4. Hidimba

Q.8 Guru Vempati Chinna Satyam has gained global recognition for the spread of which of the following classical dance forms of India?

- Ans
- 1. Bharatanatyam
 - 2. Kuchipudi
 - 3. Sattriya
 - 4. Kathak

Q.9 'Both Feet on the Ground' is an autobiography of which of the following players?

- Ans
- 1. Cristiano Ronaldo
 - 2. David Beckham
 - 3. Lionel Messi
 - 4. Bobby Moore

Q.10 Kolayat festival is celebrated in which Indian state?

- Ans
- 1. Madhya Pradesh
 - 2. Bihar
 - 3. Rajasthan
 - 4. Jharkhand

Q.11 Which of the following was NOT a reason for emphasizing industrial development in the five year plans?

- Ans
- 1. Industry provides more stable employment than agriculture
 - 2. Industry promotes modernisation
 - 3. Industry doesn't require high investment
 - 4. Industry promotes overall prosperity

Q.12 In which of the following years did the badminton player PV Sindhu win the Olympics Medal?

- Ans
- 1. 2016 and 2020
 - 2. 2008 and 2012
 - 3. 2004 and 2008
 - 4. 2012 and 2020

Q.13 The study of cell structure is called _____.

- Ans
- 1. cytology
 - 2. Fisheries
 - 3. Anatomy
 - 4. Morphology

Q.14 'Lone Fox Dancing' is an autobiography by which of the following novelists?

- Ans
- 1. Arvind Adiga
 - 2. Ruskin Bond
 - 3. Amitav Ghosh
 - 4. Khushwant Singh

Q.15 When were female participants formally admitted to the Olympic Games?

- Ans
- 1. Helsinki, 1952
 - 2. Paris, 1900
 - 3. Berlin, 1936
 - 4. London, 1908

Q.16 Which of the following is NOT one of the problems with microfinance?

- Ans
- 1. Lack of transparency and absence of governance structure
 - 2. Operational, attitudinal and policy-level constraints
 - 3. Excess flow of funds towards microfinance
 - 4. Skewed growth across the country

Q.17 Fa-Hien visited India during the reign of which of the following Gupta Kings?

- Ans
- 1. Budhagupta
 - 2. Bhanugupta
 - 3. Chandragupta II
 - 4. Samudragupta

Q.18 According to India Brand Equity Foundation (IBEF), India has the _____ largest road network in the world (as of August 2022).

- Ans
- 1. second
 - 2. fourth
 - 3. third
 - 4. first

Q.19 Which of the following is NOT a primary objective of the Special Economic Zone?

- Ans
- 1. Providing employment
 - 2. Promoting clean technology
 - 3. Promoting export
 - 4. Development of infrastructure

Q.20 Where did Dadabhai Naoroji establish the East India Company Association?

- Ans
- 1. Paris
 - 2. Delhi
 - 3. London
 - 4. Lucknow

Q.21 Which of the following is needed for the formation of haemoglobin?

- Ans
- 1. P
 - 2. Ca
 - 3. Fe
 - 4. Cu

Q.22 According to the Agricultural and Processed food products Export Development Authority (APEDA) 2021-2022, which state of India has the first rank in mango production?

- Ans
- 1. Bihar
 - 2. Uttar Pradesh
 - 3. Karnataka
 - 4. Maharashtra

Q.23 Gurmeet Bawa, who received the Padma Bhushan posthumously in 2022, hails from which of the following states?

Ans 1. Punjab

2. Maharashtra

3. Uttarakhand

4. Haryana

Q.24 Which of the following Acts created a unified administration system for India?

Ans 1. Pitt's India Act of 1784

2. Regulating Act of 1813

3. Regulating Act of 1793

4. Regulating Act of 1773

Q.25 Which of the following Articles of the Constitution of India lays down that it is our duty to defend the country and render national service when called upon to do so?

Ans 1. Article 51 A (f)

2. Article 51 A (d)

3. Article 51 A (g)

4. Article 51 A (e)

Q.26 Which of the following is NOT correct about agriculture industry?

Ans 1. Green revolution resulted in the improvement in oilseeds.

2. Green revolution started the usage of HYV seeds.

3. Green revolution enabled India to achieve self-sufficiency in food grain production.

4. Green revolution led to the introduction of new technology.

Q.27 Who converted Menander to Buddhism?

Ans 1. Nagasena

2. Buddhaghosh

3. Asvaghosha

4. Bhadrabahu

Q.28 Which of the following is NOT true regarding the antioxidants?

Ans 1. It delays the ageing process.

2. Animal products are the chief source of antioxidants.

3. It helps in the repair of cellular functions.

4. It prevents the damage of cellular functions.

Q.29 According to the census of India 2011, which state has the second highest density of population per square kilometre?

Ans 1. Bihar

2. Andhra Pradesh

3. Uttar Pradesh

4. West Bengal

Q.30 Where was the Prarthana Samaj established in the 1860s?

Ans 1. United Provinces

2. Maharashtra

3. Madras

4. Bengal

Q.31 What does 'E' stand for in SEBI?

- Ans
- 1. Electronically
 - 2. Electronic
 - 3. Energy
 - 4. Exchange

Q.32 Which of the following forts is located in Goa?

- Ans
- 1. Fort Aguada
 - 2. Chandragiri Fort
 - 3. Jaigarh Fort
 - 4. Bekal Fort

Q.33 Name the monument constructed by Akbar in 1575 to celebrate his victory over Gujarat.

- Ans
- 1. Panch Mahal
 - 2. Buland Darwaja
 - 3. Jama Masjid
 - 4. Sheikh Salim Chisti Dargah

Q.34 The 11th Fundamental Duty was added to the Indian Constitution by the _____ Constitutional Amendment Act.

- Ans
- 1. 86th
 - 2. 84th
 - 3. 88th
 - 4. 87th

Q.35 Pandit Bhimsen Joshi is associated with the _____.

- Ans
- 1. Banaras gharana
 - 2. Patiala gharana
 - 3. Agra gharana
 - 4. Kirana gharana

Q.36 Who among the following is the author of the book Kitab-ul-Hind?

- Ans
- 1. Shihabuddin al-Umari
 - 2. Al-Biruni
 - 3. Al Masudi
 - 4. Ibn Battuta

Q.37 Which Article of the Constitution of India empowers the Indian President to constitute a GST Council by an order?

- Ans
- 1. Article 279-A
 - 2. Article 277-A
 - 3. Article 280-A
 - 4. Article 278-A

Q.38 Pandit Birju Maharaj, Padma Bhushan awardee, was a globally renowned dancer of which of the following gharanas of Kathak?

- Ans
- 1. Raigarh
 - 2. Kalka-Bindadin
 - 3. Janaki Prasad
 - 4. Jaipur

Q.39 Who among the following Indian reformers is credited with the campaign for widow remarriage and on whose su law was passed by the British officials in 1856, permitting the same?

- Ans**
- 1. Savitri Bai Phule
 - 2. Ishwar Chandra Vidyasagar
 - 3. Mumtaz Ali
 - 4. Ayyankali

Q.40 The Harike Barrage has been constructed at the confluence of which two rivers?

- Ans**
- 1. Beas and Sutlej
 - 2. Ganga and Yamuna
 - 3. Mahanadi and Damodar
 - 4. Luni and Subarnarekha

Q.41 The 'Kachin Manaw Festival' is associated with which of the following countries?

- Ans**
- 1. Sri Lanka
 - 2. Pakistan
 - 3. Myanmar
 - 4. Maldives

Q.42 Football 2027 Asian Cup will be hosted by _____.

- Ans**
- 1. Japan
 - 2. Bangladesh
 - 3. India
 - 4. Saudi Arabia

Q.43 Identify the correct statements about Independence Day and Republic Day of India.

- i) Independence Day is celebrated on 15th August since 1947.
- ii) Republic Day is celebrated on 26th January since 1950.
- iii) Independence Day is celebrated as Independence from British rule.
- iv) Republic day is celebrated since the Constituent Assembly of India adopted the Constitution of India in 1949.

- Ans**
- 1. ii, iii and iv
 - 2. i, iii and iv
 - 3. i, ii and iii
 - 4. i, ii and iv

Q.44 Meenakshisundaram Pillai, a dance guru from the village of Pandanallur, was famous for which of the following dance forms?

- Ans**
- 1. Kathak
 - 2. Bharatnatyam
 - 3. Odissi
 - 4. Mohiniyattam

Q.45 The post of Vice President has been taken from the Constitution of _____.

- Ans**
- 1. The US
 - 2. Australia
 - 3. Germany
 - 4. The UK

Q.46 According to the Census of India 2011, which state recorded the highest sex ratio?

- Ans**
- 1. Karnataka
 - 2. Kerala
 - 3. Tamil Nadu
 - 4. Andhra Pradesh

Q.47 In foreign technology agreements, automatic permission is provided in high priority industry up to a sum of _____

- Ans
- 1. ₹1 crore
 - 2. ₹2.5 crore
 - 3. ₹2 crores
 - 4. ₹1.5 crore

Q.48 In which of the following cases is a member of the State Legislature NOT required to vacate his/her seat?

- Ans
- 1. Absence for a week without permission
 - 2. Resignation
 - 3. Double membership
 - 4. Disqualification

Q.49 Who pioneered the concept of microfinance?

- Ans
- 1. Anna Hazare
 - 2. Medha Patkar
 - 3. Mohammad Yunus
 - 4. Ela Bhatt

Q.50 Which weather phenomenon is defined as the movement of large-scale winds around a central region of high atmospheric pressure?

- Ans
- 1. Tropical cyclone
 - 2. Extratropical cyclone
 - 3. Polar cyclone
 - 4. Anticyclone

Section : Reasoning

Q.1 Select the word-pair that best represents a similar relationship to the one expressed in the pair of words given below. (The words must be considered as meaningful English words and must not be related to each other based on the number of letters/number of consonants/vowels in the word.)
Hexagon : Septagon

- Ans
- 1. Triangle : Rectangle
 - 2. Area : Square
 - 3. Radius : Diameter
 - 4. Chord : Circle

Q.2 Select the figure from the given options that can replace the question mark (?) in the following series.

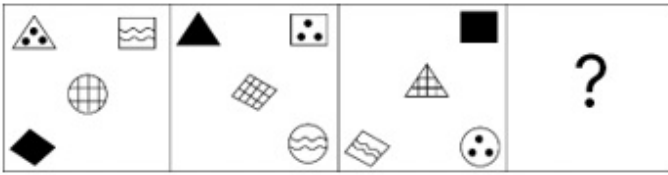

Ans

✗ 1.

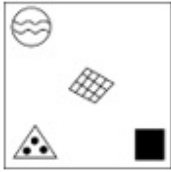

✓ 2.



✗ 3.



✗ 4.



Q.3 Select the number from among the given options that can replace the question mark (?) in the following series.
2, 4, 12, 48, ?, 1440

Ans ✓ 1. 240

✗ 2. 640

✗ 3. 960

✗ 4. 480

Prepare 50% Faster

Q.4 Select the correct mirror image of the given figure when the mirror is placed at MN as shown in

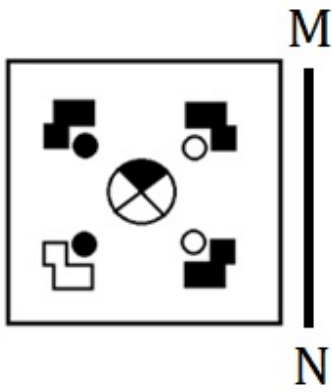

Ans

X 1.

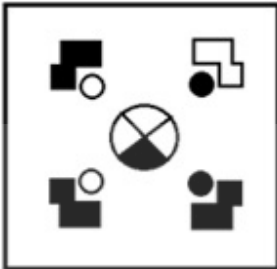

✓ 2.



X 3.



X 4.

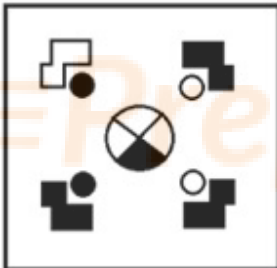

Q.5 Select the correct mirror image of the given figure when the mirror is placed at PQ as shown below.

R d v 6 4 L f K

P
|
Q

Ans

✗ 1. K f L 4 9 v p R

✗ 2. R v 6 4 L f K

✓ 3. R q v 6 L f K

✗ 4. R q v 6 L 4 f K



Prepare 50% Faster

Q.6

Select the option figure which is embedded in the given figure. (Rotation is NOT a

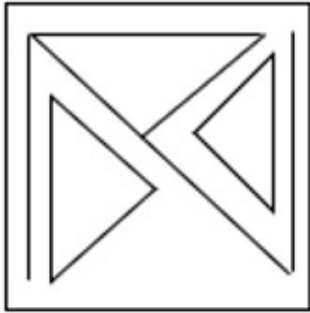

Ans

✗ 1.



✗ 2.



✓ 3.



✗ 4.

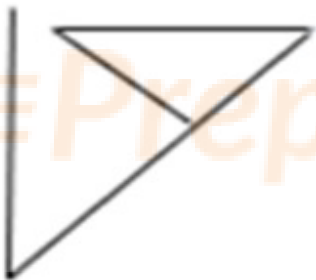

Q.7 Q, R, S, T, U and V were six doctors sitting around a circular table, facing the centre. They were equidistant from each other. Q was to the immediate right of U. R was exactly in between V and T. S was to the immediate right of Q. T was second to the left of Q. Who among the following was sitting third to the right of U?

- Ans
- ✗ 1. T
 - ✗ 2. S
 - ✗ 3. R
 - ✓ 4. V

Q.8 The following figures show the sequence of folding a piece of paper. The last figure shows the manner in which the folded paper has been cut. Choose a figure which would most closely resemble the unfolded form of the paper.

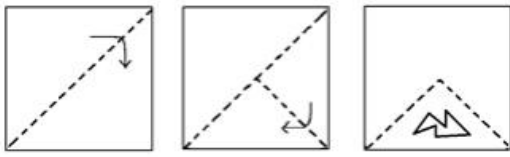

Ans

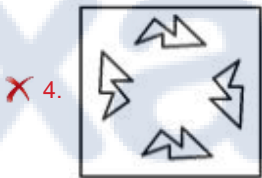
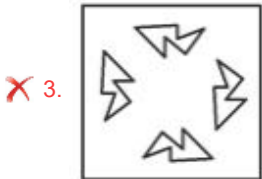
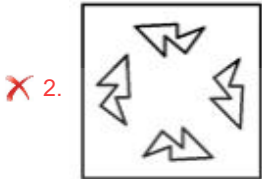
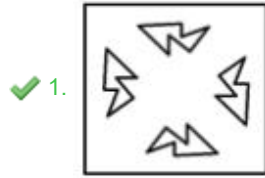

Prepare 50% Faster

Q.9 A paper is folded and cut as shown below. How will it appear when unfolded?

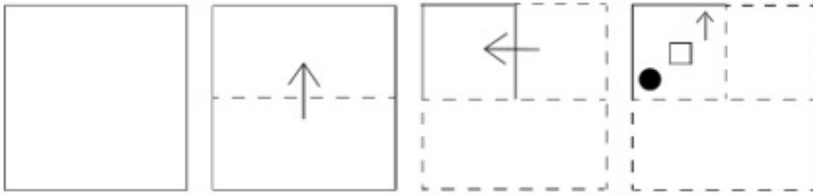

Ans

- ✗ 1.
- ✓ 2.
- ✗ 3.
- ✗ 4.

Q.10 In a certain code language, 'PIG' is written as '49' and 'HAT' is written as '52'. How will 'CAB' be written in that language?

- Ans
- ✗ 1. 63
 - ✗ 2. 79
 - ✗ 3. 51
 - ✓ 4. 75

Q.11 How many triangles are there in the given figure?

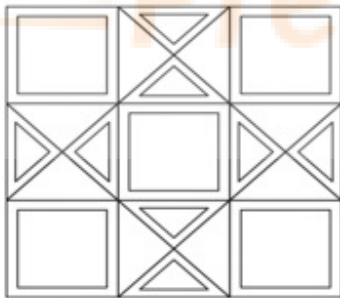

- Ans
- ✗ 1. 24
 - ✗ 2. 44
 - ✗ 3. 40
 - ✓ 4. 52

Q.12 Select the correct combination of mathematical signs to sequentially replace the * signs and to balance the given
 $12 * 5 * 9 * 54 * 9 = 1$

- Ans
- 1. $\times, \times, \div, +$
 - 2. $\times, \times, \div, -$
 - 3. $+, \times, \div, -$
 - 4. $\times, \times, -, -$

Q.13 Select the option in which the given figure is embedded (rotation is NOT allowed).

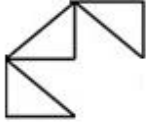

- Ans
- 1.
 - 2.
 - 3.
 - 4.

Q.14 Select the figure from among the given options that can replace the question mark (?) in the following series.

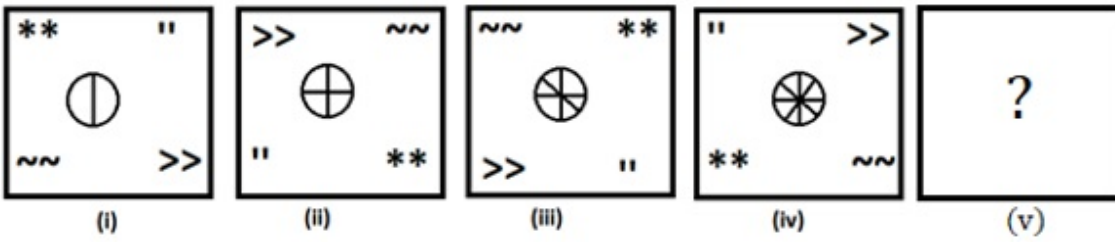

Ans

1.

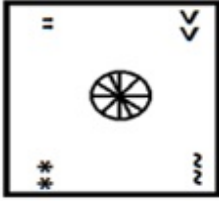

2.



3.



4.

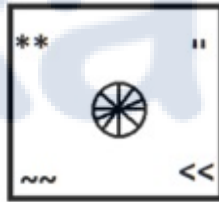

Q.15 Which of the following terms will replace the question mark (?) in the given series?
XUEJ, TRIM, ?, LLQS, HIUV

1. PPMO

2. QONN

3. QONO

4. POMP

Prepare 50% Faster

Q.16 Select the figure that will come next in the following figure series.

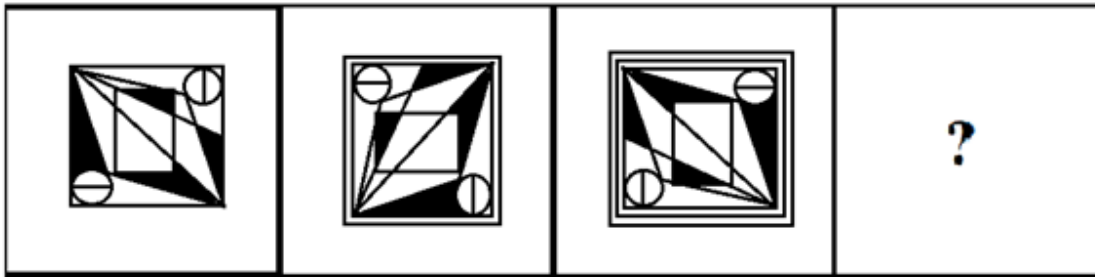

Ans

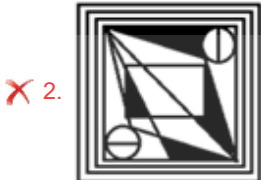
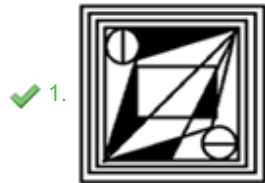

Q.17 Two statements are given followed by two conclusions numbered I and II. Assuming the statements to be true, even if they seem to be at variance with commonly known facts, decide which of the conclusions logically follow(s) from the statements.

Statements:

All cakes are candies.

No pastry is a candy.

Conclusions:

I. All pastries are cakes.

II. Some cakes are pastries.

- Ans
- ✗ 1. Only conclusion I follows
 - ✗ 2. Both conclusions I and II follow
 - ✗ 3. Only conclusion II follows
 - ✓ 4. Neither conclusion I nor II follows

Q.18 Select the set in which the numbers are related in the same way as are the numbers of the following sets. (NOTE: Operations should be performed on the whole numbers, without breaking down the numbers into its constituent digits. E.g. 13 – Operations on 13 such as adding/deleting/multiplying etc. to 13 can be performed. Breaking down 13 into 1 and 3 and then performing mathematical operations on 1 and 3 is not allowed)

(18, 28, 38)

(11, 26, 41)

- Ans
- ✗ 1. (9, 27, 43)
 - ✓ 2. (18, 35, 52)
 - ✗ 3. (13, 24, 37)
 - ✗ 4. (17, 48, 53)

Q.19 Select the correct mirror image of the given figure when the mirror is placed at MN as shown below.

XWS369

M

N

- Ans
- 1. 9032WX
 - 2. 9032WX
 - 3. 903SWX
 - 4. 903SWX

Q.20 Select the option that is related to the third term in the same way as the second term is related to the first term and the sixth term is related to the fifth term.
 $8 : 2 :: 12 : ? :: 24 : 10$

- Ans
- 1. 4
 - 2. 2
 - 3. 6
 - 4. 8

Q.21 Select the correct combination of mathematical signs to sequentially replace the * signs and to balance the given equation.
 $200 * 13 * 9 * 200 * 25 = 75$

- Ans
- 1. -, ×, -, ÷
 - 2. ×, ÷, +, -
 - 3. +, ×, -, ÷
 - 4. ÷, -, ×, +

Prepare 50% Faster

Q.22 Select the option in which the given figure is embedded (rotation is NOT allowed).



Ans

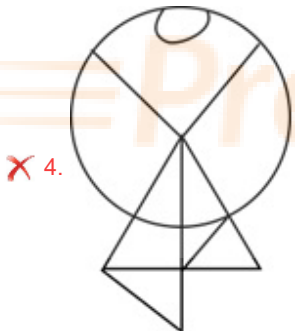
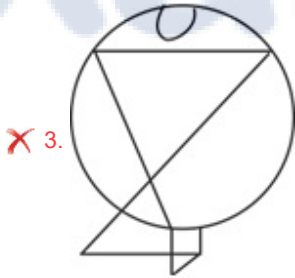
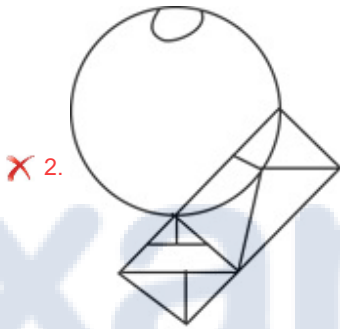
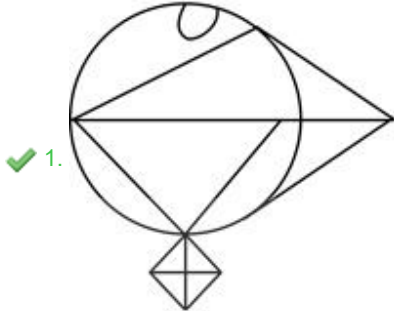

Q.23 Select the option figure which is embedded in the given figure as its part (rotation is NOT allowed).



Ans

✓ 1.



✗ 2.



✗ 3.



✗ 4.



Q.24 Select the option in which the given figure is embedded (rotation is NOT allowed).

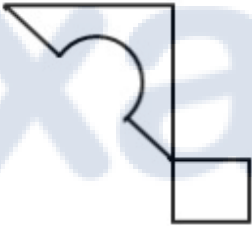

Ans

✓ 1.

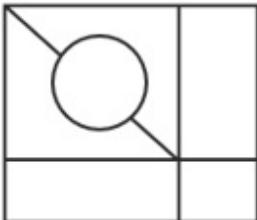

✗ 2.

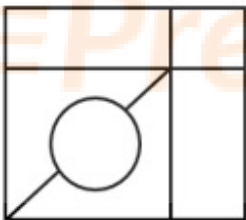

✗ 3.

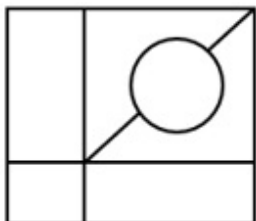

✗ 4.

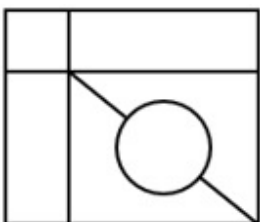

Q.25 Select the option figure that will replace the question mark (?) in the figure given below to complete the pattern.

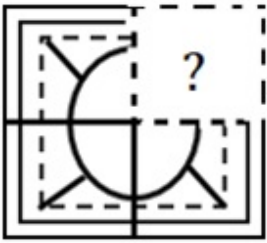

Ans

✓ 1.



✗ 2.

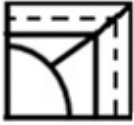

✗ 3.



✗ 4.



Section : Numerical Ability

Q.1 If $\frac{844}{0.844} = \frac{84.4}{K}$, then what is the value of K?

Ans ✓ 1. 0.0844

✗ 2. 0.00844

✗ 3. 0.844

✗ 4. 8.44

Q.2 A sum of ₹2,400 yields a simple interest of ₹460 in 2 years and 4 months. The rate of interest per annum is:

Ans ✗ 1. $5\frac{3}{14}\%$

✗ 2. $7\frac{5}{14}\%$

✓ 3. $8\frac{3}{14}\%$

✗ 4. $7\frac{3}{14}\%$

Q.3 What is the area of an equilateral triangle whose sides are $8\sqrt{3}$ cm?

Ans ✓ 1. $48\sqrt{3}$ cm²

✗ 2. $46\sqrt{3}$ cm²

✗ 3. $38\sqrt{3}$ cm²

✗ 4. $42\sqrt{3}$ cm²

Q.4 The ratio of the salaries of Ram and Shyam is 8 : 5. If the salaries of Ram and Shyam are increased by ₹2,600, the becomes 15 : 11. What is the salary of Shyam?

- Ans
- 1. ₹5,000
 - 2. ₹4,000
 - 3. ₹4,500
 - 4. ₹3,500

Q.5 A train covers a distance of 10 km in 10 minutes. If its speed is decreased by 20 km/h, then the time taken by it to cover the same distance will be:

- Ans
- 1. 15 minutes
 - 2. 12 minutes
 - 3. 18 minutes
 - 4. 20 minutes

Q.6 If the area of great circle is 36π m², then find the volume of a hemisphere.
(Use $\pi=3.14$)

- Ans
- 1. 458.74 m³
 - 2. 452.16 m³
 - 3. 445.68 m³
 - 4. 464.32 m³

Q.7 The price of a car increased by 25%. By what percentage should the price now be reduced to bring it to the actual price?

- Ans
- 1. 35%
 - 2. 20%
 - 3. 15%
 - 4. 25%

Q.8 The highest common factor of 161 and 207 is:

- Ans
- 1. 23
 - 2. 1
 - 3. 7
 - 4. 9

Q.9 Anjali and Manju together can do a piece of work in 5 days. If Anjali does twice as much work as Manju in a given time, how long would Anjali alone take to do the work?

- Ans
- 1. 7 days
 - 2. 6.5 days
 - 3. 7.5 days
 - 4. 6 days

Q.10 Which ratio is the greatest among the following?

- Ans
- 1. 3 : 5
 - 2. 5 : 8
 - 3. 1 : 3
 - 4. 4 : 7

Q.11 Joy borrowed some amount from a bank at the rate of 6% per annum, compounded annually. If he finished paying his loan by paying ₹20,000 at the end of 5 years, then the amount of loan that he had taken (rounded to the nearest thousand rupees) was:

- Ans
- 1. ₹13,000
 - 2. ₹16,000
 - 3. ₹15,000
 - 4. ₹12,000

Q.12 $\frac{17}{250}$ is equivalent to:

- Ans
- 1. 0.068
 - 2. 0.68
 - 3. 0.088
 - 4. 0.0068

Q.13 A shopkeeper offers a discount of 15% on the marked price of an article and still makes a profit of 25%. If its marked price is ₹2,100, then find the cost price of the article.

- Ans
- 1. ₹1,248
 - 2. ₹1,842
 - 3. ₹1,284
 - 4. ₹1,428

Q.14 The average of n natural odd numbers is _____, where n is odd.

- Ans
- 1. n
 - 2. $n + 1$
 - 3. $\frac{n}{2}$
 - 4. $\frac{n + 1}{2}$

Q.15 If the loss is $\frac{1}{6}$ of the selling price of an article, then the loss percentage is:

- Ans
- 1. $14\frac{2}{7}\%$
 - 2. $16\frac{1}{7}\%$
 - 3. $13\frac{1}{7}\%$
 - 4. $12\frac{3}{7}\%$

Section : Computer Proficiency

Q.1 In MS Excel 365, which menu or tab is used to access the 'Save' or 'Save as' options?

- Ans
- 1. File
 - 2. Edit
 - 3. Insert
 - 4. Home

Q.2 What is the maximum number of columns existing in MS-Excel 2010?

- Ans
- 1. 8,382 columns
 - 2. 32,386 columns
 - 3. 16,384 columns
 - 4. 2,048 columns

Q.3 When we open MS-Word 365, which of the following could be found?

- Ans**
- 1. Blank page without any default name
 - 2. Blank page with a default name "Document1"
 - 3. Blank page with a default name "page 1"
 - 4. Blank page with a default name "Doc 1"

Q.4 Which of the following is an example of web browser?

- Ans**
- 1. Mozilla Firefox
 - 2. Google Search
 - 3. Yahoo mail
 - 4. Outlook 365

Q.5 What does the 'Grammar Check' feature in MS-Word 365 do?

- Ans**
- 1. It formats the text based on predefined style rules.
 - 2. It identifies and provides suggestions to correct grammatical errors in the text.
 - 3. It provides suggestions to improve the document's structure.
 - 4. It highlights correct spelling and offers suggestions.

Q.6 Which of the following is NOT used to modify selected text in MS-Word 365?

- Ans**
- 1. Ctrl + B
 - 2. Ctrl + I
 - 3. Ctrl + U
 - 4. Ctrl + O

Q.7 In Print Preview mode in Microsoft Word 365, what can you review and modify before printing the document?

- Ans**
- 1. Document content and editing options
 - 2. Page layout
 - 3. Font styles and sizes
 - 4. Printer connectivity and network settings

Q.8 Which of the following tabs on the MS Excel 365 ribbon has the 'Sort & Filter' group?

- Ans**
- 1. Formula
 - 2. Review
 - 3. Edit
 - 4. Data

Q.9 Which protocol is commonly used for sending emails from a client to a server?

- Ans**
- 1. Internet Messaging Access Protocol (IMAP)
 - 2. Simple Mail Transfer Protocol (SMTP)
 - 3. Post office Protocol (POP3)
 - 4. Hypertext Transfer Protocol (HTTP)

Q.10 What is the function of the 'Superscript' feature in Microsoft Word 365?

- Ans**
- 1. Makes the text larger and below the baseline
 - 2. Adds a line under the text
 - 3. Makes the text bold and italic
 - 4. Makes the text smaller and above the baseline

Constable Executive Male and Female in Delhi Police Examination 2023

Exam Date	22/11/2023
Exam Time	9:00 AM - 10:30 AM
Subject	Constable Executive Male and Female in Delhi Police Examination 2023

Section : General Knowledge

Q.1 In which year was Indian Olympic Association formed?

- Ans**
- 1. 1927
 - 2. 1928
 - 3. 1900
 - 4. 1920

Q.2 Identify the correct pair of Indian Dancers who received the Sangeet Natak Akademi Awards 2021 for their contributions in Bharatanatyam and Kathak, respectively.

- Ans**
- 1. Trilochan Mohanta and Mamta Shankar
 - 2. Radha Sridhar and Kumkum Dhar
 - 3. Jayalakshmi Eshwar and Shama Bhate
 - 4. Geeta Chandran and Rajashree Shirke

Q.3 Which of the following statements is correct about membership in the World Trade Organization (WTO)?

- Ans**
- 1. India reduced trade restrictions due to obligations to WTO.
 - 2. It was established as a new organisation in 1991.
 - 3. It negotiates only bilateral trade agreements between countries.
 - 4. All the countries of the world are members of WTO.

Q.4 Article 21A pertains to which of the following rights?

- Ans**
- 1. Right to Freedom of Religion
 - 2. Right to Equality
 - 3. Right to Education
 - 4. Right to Freedom

Q.5 Which is the first known instrument to measure the humidity of air or gas, built by Leonardo da Vinci around 1400?

- Ans**
- 1. Disdrometer
 - 2. Transmissometer
 - 3. Hygrometer
 - 4. Sling psychrometer

Q.6 The kinetic energy of the constitute molecules of the matter is minimum for its:

- Ans**
- 1. gas state
 - 2. solid state
 - 3. liquid state
 - 4. plasma state

Q.7 The English word juggernaut comes from the name Jagannath, meaning 'Lord of the World'. Where is the world-famous Shree Jagannath temple located?

- Ans**
- 1. Kolkata
 - 2. Puri
 - 3. Cuttack
 - 4. Bhubaneswar

Q.8 Which of the following is the most abundant mineral in our body?

- Ans**
- 1. Phosphorous
 - 2. Calcium
 - 3. Copper
 - 4. Iron

Q.9 Mera Houchongba is an important festival to celebrate peace in which Indian state?

- Ans**
- 1. Chhattisgarh
 - 2. Assam
 - 3. Manipur
 - 4. Jharkhand

Q.10 Goa is well known for which of the following ores?

- Ans**
- 1. Iron and manganese
 - 2. Uranium and copper
 - 3. Gold and graphite
 - 4. Petroleum and coal

Q.11 This temple, that was built by Raja Bhimdev I of the Solanki Dynasty, has a rectangular pond called 'Surya Kund' in front of it. What is the name of this temple?

- Ans**
- 1. Konark Sun Temple
 - 2. Chausath Yogini
 - 3. Khajuraho
 - 4. Modhera Sun Temple

Q.12 What is the State religion of Maldives?

- Ans**
- 1. Hinduism
 - 2. Christianity
 - 3. Buddhism
 - 4. Islam

Q.13 The Public Accounts Committee consists of _____ members from Lok Sabha and _____ from Rajya Sabha.

- Ans**
- 1. 13, 9
 - 2. 15, 7
 - 3. 14, 8
 - 4. 12, 10

Q.14 In 2003, _____ became the first Indian woman dancer to be awarded with the Padma Vibhushan.

- Ans**
- 1. Sonal Mansingh
 - 2. Shovana Narayan
 - 3. Rukmini Devi Arundale
 - 4. Sitara Devi

Q.15 At independence, which was the major employment-producing sector?

- Ans
- 1. Service
 - 2. Foreign trade
 - 3. Industrial
 - 4. Agriculture

Q.16 _____ tribe is one of India's largest tribal groups, according to the 2011 census.

- Ans
- 1. Khasi
 - 2. Kodava
 - 3. Bhil
 - 4. Bhutia

Q.17 What was the primary outcome of the liberalisation and privatisation initiatives under the New Economic Policy (NEP) in 1991, followed by the Indian government?

- Ans
- 1. Globalisation
 - 2. Fiscal policy reforms
 - 3. Monetary policy reforms
 - 4. Centralization

Q.18 The Montagu-Chelmsford Reforms led to enactment of the Government of India Act of:

- Ans
- 1. 1919
 - 2. 1858
 - 3. 1935
 - 4. 1909

Q.19 How many questions were canvassed during Population Enumeration in the 2011 Census of India?

- Ans
- 1. 21
 - 2. 29
 - 3. 16
 - 4. 23

Q.20 How many Rasas are presented in classical dances?

- Ans
- 1. 6
 - 2. 5
 - 3. 9
 - 4. 7

Q.21 In which of the following years was the Indian National Congress founded, in Bombay?

- Ans
- 1. 1885
 - 2. 1889
 - 3. 1892
 - 4. 1880

Q.22 The height of the net in volleyball for women must be _____.

- Ans
- 1. 2.43 m
 - 2. 2.24 m
 - 3. 2.15 m
 - 4. 2.10 m

Q.23 Deepa Sashindran, Raja Reddy and Radha Reddy are associated with which of the following Indian dances?

- Ans
- 1. Bharatanatyam
 - 2. Kathak
 - 3. Kuchipudi
 - 4. Kathakali

Q.24 _____ is the first South Indian musician to win a Grammy for Best World Music Album for his role as a ghatam and morsing player in Mickey Hart's album 'Planet Drum'.

- Ans
- 1. TH Vinayakram
 - 2. Dr. Ramachandra Murthy
 - 3. S Ballesh
 - 4. Phani Narayana

Q.25 What is the study of coins called?

- Ans
- 1. Numismatics
 - 2. Almanac
 - 3. Curator
 - 4. Petroglyphs

Q.26 Who is the only living representative of the extremely ancient and diverse group, Sphenopsida, commonly known as 'horsetails'?

- Ans
- 1. Dryopteris
 - 2. Adiantum
 - 3. Psilotum
 - 4. Equisetum

Q.27 In which year was the 11th Fundamental duty added to the Indian Constitution?

- Ans
- 1. 2003
 - 2. 2002
 - 3. 2001
 - 4. 2000

Q.28 Select the correct arrangement of the taxonomic hierarchy in ascending order from the following.

- a Genus → Species → Family → Order → Class → Phylum → Kingdom
- b Genus → Species → Family → Class → Order → Phylum → Kingdom
- c Species → Genus → Family → Order → Class → Phylum → Kingdom
- d Species → Genus → Family → Order → Phylum → Class → Kingdom

- Ans
- 1. a
 - 2. d
 - 3. b
 - 4. c

Q.29 The Prayaga Prashasti (also known as the Allahabad Pillar Inscription) was composed in Sanskrit by Harishena, the court poet of:

- Ans
- 1. Samudragupta
 - 2. Kharavela
 - 3. Asoka
 - 4. Harshavardhana

Q.30 The Gateway of India, located in the city of Mumbai, is built in which of the following architectural styles?

- Ans
- 1. Indo-British
 - 2. Indo-Saracenic
 - 3. Indo-Greek
 - 4. Indo-Sino

Q.31 What was India's rank in the medal tally at Tokyo Olympic 2020?

- Ans
- 1. 58
 - 2. 48
 - 3. 35
 - 4. 38

Q.32 Who produced the document of Mahzar at the instance of Akbar?

- Ans
- 1. Faizi
 - 2. Abul Fazl
 - 3. Abdun Nabi
 - 4. Shaikh Mubarak

Q.33 'Raseedi Ticket' is an autobiography written by:

- Ans
- 1. Baby Halder
 - 2. Khushwant Singh
 - 3. Amrita Pritam
 - 4. Ismat Chughtai

Q.34 'National AYUSH Mission' has been extended up to 31st March 2026. When was the scheme launched?

- Ans
- 1. 2012
 - 2. 2016
 - 3. 2014
 - 4. 2015

Q.35 Which type of electoral system has been adopted in case of Rajya Sabha by the Constitution?

- Ans
- 1. Proportional Representation
 - 2. Two Party System
 - 3. First Past The Post
 - 4. One Party System

Q.36 Totaram Sharma is a famous _____ player.

- Ans
- 1. flute
 - 2. pakhawaj
 - 3. sarangi
 - 4. guitar

Q.37 As a factor of cost, what is the other name of the net national product?

- Ans
- 1. Gross national product
 - 2. Net domestic product
 - 3. National income
 - 4. Personal income

Q.38 As per the National Infrastructure Pipeline 2019-25, what is the share of energy sector projects out of the total es capital expenditure of ₹111 lakh crore?

- Ans**
- 1. 40%
 - 2. 17%
 - 3. 24%
 - 4. 37%

Q.39 North-South corridor, that is part of Golden Quadrilateral super highways connects which two States/Union Territories?

- Ans**
- 1. Chandigarh and Tamil Nadu
 - 2. Assam and Gujarat
 - 3. Rajasthan and West Bengal
 - 4. Jammu & Kashmir and Tamil Nadu

Q.40 GNP at market price is measured as:

- Ans**
- 1. GNP at market price + subsidies
 - 2. NDP at factor cost + Net factor income from abroad
 - 3. GDP at market price – Depreciation
 - 4. GDP at market price + Net factor income from abroad

Q.41 Jeev Milkha Singh specialises in which event?

- Ans**
- 1. Shooting
 - 2. Golf
 - 3. Weight lifting
 - 4. Athletics

Q.42 Which of the following Articles has been inserted in the Indian Constitution by the Constitution (Eighty-Sixth Amendment) Act, 2002?

- Ans**
- 1. Article 55-A
 - 2. Article 31-A
 - 3. Article 21-A
 - 4. Article 25-A

Q.43 Which of the following does NOT come under Fundamental Duties?

- Ans**
- 1. To value and preserve rich heritage
 - 2. To cherish and follow the noble ideals that inspired the national struggle for freedom
 - 3. To secure a living wage
 - 4. To safeguard public property

Q.44 A small scale industry is defined with reference to the maximum investment allowed on assets which is equal to _____.

- Ans**
- 1. ₹5 lakhs
 - 2. ₹1 crore
 - 3. ₹10 lakhs
 - 4. ₹10 crores

Q.45 The Delhi Sultans built many cities in the area that is known as Delhi today. Which of the following was NOT built by them?

- Ans**
- 1. Siri
 - 2. Lal Kot
 - 3. Tughlakabad
 - 4. Jahanpanah

Q.46 During the peak of the revolutionary phase of the Indian freedom struggle, an assassination attempt on a district of Muzaffarpur led to the uncovering of the Alipore Conspiracy in 1908. What was the name of the magistrate?

- Ans**
- 1. Robert Lytton
 - 2. JP Saunders
 - 3. Edward Irwin
 - 4. Douglas Kingsford

Q.47 'Bathukamma' is a colourful floral festival of _____ celebrated by womenfolk with exotic flowers of the region.

- Ans**
- 1. Karnataka
 - 2. Rajasthan
 - 3. Telangana
 - 4. Gujarat

Q.48 Which layer of the atmosphere is suitable and most important to humans?

- Ans**
- 1. Mesosphere
 - 2. Exosphere
 - 3. Stratosphere
 - 4. Troposphere

Q.49 The Chief Minister of a State acts as _____ of the concerned zonal council on rotation basis along with the other Chief Ministers in that zonal council.

- Ans**
- 1. Member
 - 2. Ex- officio Chairman
 - 3. Chairman
 - 4. Vice Chairman

Q.50 The novel 'The Inheritance of Loss' is written by:

- Ans**
- 1. Anees Salim
 - 2. Kiran Desai
 - 3. Anita Desai
 - 4. Aravind Adiga

Section : Reasoning

Q.1 Seven students, A, B, C, D, E, F and G, are standing in a straight line facing north. D is standing to the immediate left of E but to the immediate right of C. B is standing to the immediate right of A and to the immediate left of C. Similarly, F is standing to the immediate left of G, who is standing at the extreme right end. Who is standing at the third position from the left end?

- Ans**
- 1. B
 - 2. D
 - 3. E
 - 4. C

Q.2 If 'A' denotes '+', 'B' denotes 'x', 'C' denotes '-' and 'D' denotes '÷', then what will come in place of '?' in the following equation?
(8 B 4 A 3) D 7 = 33 D 11 A?

- Ans**
- 1. 7
 - 2. 5
 - 3. 2
 - 4. 9

Q.3 Select the correct mirror image of the given figure when the mirror is placed at MN as shown below.

F k Z 5 L P y

M ————— N

- Ans
- 1. **v 9 J 2 S K 7**
 - 2. **Ǝ K Σ 2 Γ Ɔ λ**
 - 3. **Ǝ K Σ 2 Γ Ɔ λ**
 - 4. **Ǝ K Σ 2 Γ Ɔ λ**

Q.4 Select the option in which the given figure is embedded (rotation is NOT allowed).



- Ans
- 1.
 - 2.
 - 3.
 - 4.

Q.5 Which of the following options will replace the question mark (?) in the given series?
3, 8, 18, 33, 53, ?, 108

- Ans
- 1. 53
 - 2. 39
 - 3. 55
 - 4. 78

Q.6 Select the option that represents the letters that, when sequentially placed from left to right in the blanks below, will complete the letter series.

M N _ _ Q M _ O _ Q _ N _ P Q M N O _ _

- Ans
- 1. PONPOMPQ
 - 2. OPNPMOPQ
 - 3. OPPNMOQP
 - 4. PONPMOQP

Q.7 A paper is folded and cut as shown below. How will it appear when unfolded?

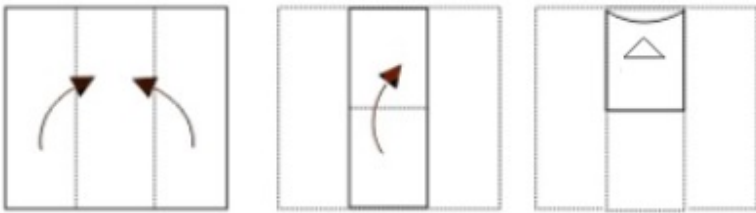

Ans

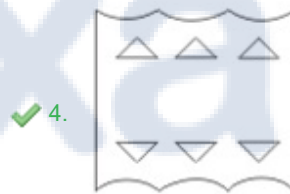
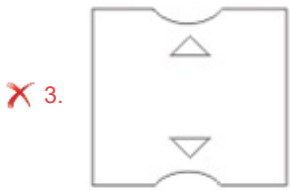
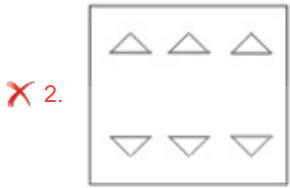
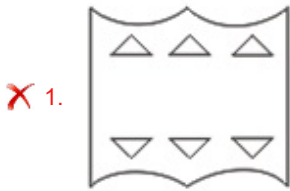

Q.8 Select the correct mirror image of the given figure when the mirror is placed at 'AB' as shown.

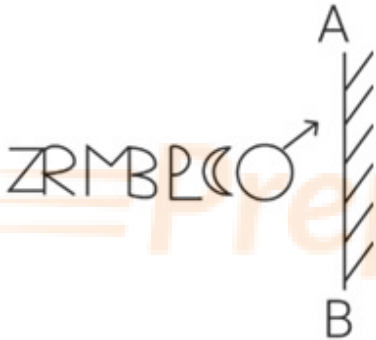

Ans

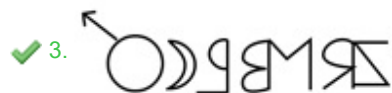
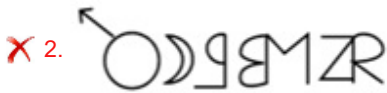

Q.9 Select the option that is related to the third word in the same way as the second word is related to the first word. must be considered as meaningful English words and must NOT be related to each other based on the number of letters/number of consonants/vowels in the word)
Brim: Edge:: Kind:?

- Ans**
- 1. Cruel
 - 2. Benevolent
 - 3. Illusion
 - 4. Artificial

Q.10 Select the correct combination of mathematical signs that can sequentially replace the * signs and balance the given equation.

$$15 * 3 * 24 * 12 * 2 * 5$$

- Ans**
- 1. ÷, +, -, ×, =
 - 2. +, -, ×, ÷, =
 - 3. +, ×, -, ÷, =
 - 4. +, ×, -, =, ÷

Q.11 Select the set in which the numbers are related in the same way as are the numbers of the following sets.

(NOTE: Operations should be performed on the whole numbers, without breaking down the numbers into its constituent digits. E.g. 13 – Operations on 13 such as adding/deleting/multiplying etc. to 13 can be performed. Breaking down 13 into 1 and 3 and then performing mathematical operations on 1 and 3 is not allowed)
(2, 9, 3), (5, 23, 4)

- Ans**
- 1. (12, 37, 4)
 - 2. (10, 33, 3)
 - 3. (11, 40, 4)
 - 4. (13, 36, 3)

Q.12 Observe the dots on a dice (one to six dots) in the following figures. How many dots are contained on the face opposite to that containing six dots?

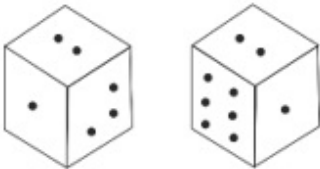

- Ans**
- 1. One
 - 2. Five
 - 3. Three
 - 4. Four

Prepare 50% Faster

Q.13 A paper is folded and cut as shown below. How will it appear when unfolded?

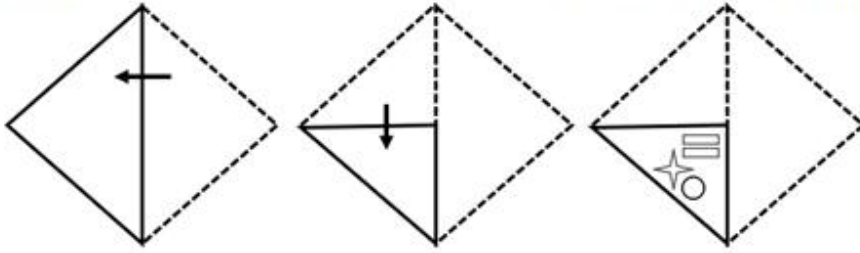

Ans

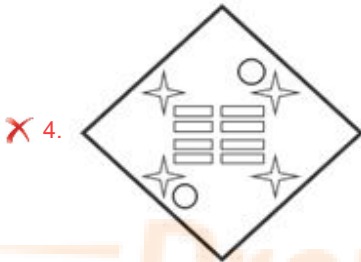
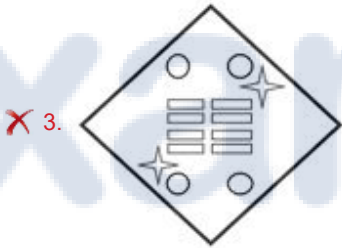
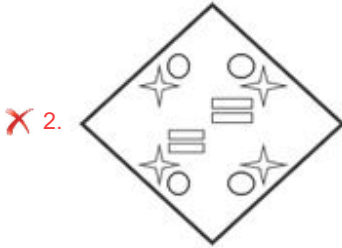
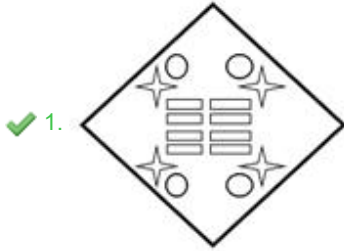

Q.14 Select the option that is related to the fifth number in the same way as the second number is related to the first number and the fourth number is related to the third number.
45 : 405 :: 20 : 80 :: 85 : ?

- Ans
- ✗ 1. 1270
 - ✓ 2. 1445
 - ✗ 3. 1255
 - ✗ 4. 1440

Q.15 Which figure should replace the question mark (?) if the following series were to be continued?

S V D q 3 O ☆ ↑ D V	3 ☆ q O ↑ S	S V O D q ☆ 3 q O V	O q S ↑ 3 D ☆ V S D	S V O q 3 ↑ D ☆	?
---	----------------------------------	--	--	--	---

Ans

- ✓ 1.

☆ D q ↑ O 3 V S
--
- ✗ 2.

☆ V 3 O ↑ q D S
--
- ✗ 3.

D ☆ 3 O ↑ q S V
--
- ✗ 4.

D S q ↑ O 3 ☆ V
--

Q.16 Select the correct mirror image of the given combination when the mirror is placed at MN as shown below.

M

P 6 w d 9 K r

|

N

- Ans
- ✗ 1. r r e p w a q
 - ✓ 2. r r e b w a q
 - ✗ 3. r w a b k e q
 - ✗ 4. q q w p e k r

Q.17 Which figure should replace the question mark (?) in the following series to continue the pattern?

△	8	↑	♡	♡	U	K	8	
B	U	L	K	△	L	U	8	B
↑	♡	B	K	K	8	B	△	?

Ans

✗ 1.

♡	K
U	B
L	8
△	↑

✗ 2.

8	△
L	↑
U	♡
K	B

✓ 3.

8	↑
B	K
L	♡
△	U

✗ 4.

B	K
U	♡
L	↑
△	8

Q.18 How many triangles are there in the given figure?



- Ans
- ✗ 1. 6
 - ✗ 2. 9
 - ✓ 3. 8
 - ✗ 4. 10

Q.19 Following question consists of 4 figures marked A, B, C and D called the Problem Figures. Select a figure from amongst the Answer Figures which will continue the same series as established by the four Problem Figures.

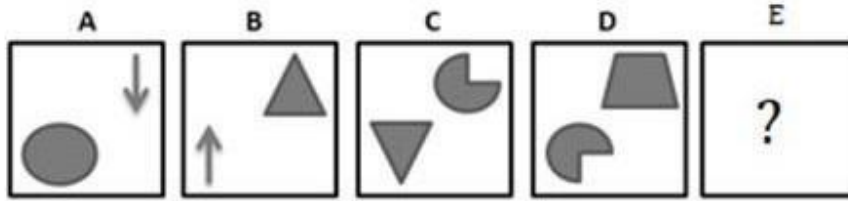

Ans

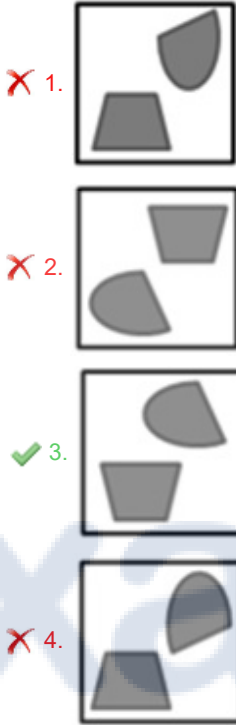

Q.20 Read the given statements and conclusions carefully. Assuming that the information given in the statements is true, even if it appears to be at variance with commonly known facts, decide which of the given conclusions logically follow(s) from the statements.

Statements:

All students are teachers.

No teacher is the Principal.

Conclusions:

I. No principal is student.

II. All teachers are students.

- Ans
- 1. Only conclusion II follows
 - 2. Both conclusions I and II follow
 - 3. Neither conclusion I nor II follows
 - 4. Only conclusion I follows

Q.21 In a certain code language, 'RADICAL' is written as 'BBDEJMS' and 'SUSPECT' is written as 'DFQTTUV'. How will 'VIRTUAL' be written in that language?

- Ans
- 1. LAUTRIV
 - 2. RIVTLAU
 - 3. BJMSUVW
 - 4. WJSUVBM

Q.22 Select the correct mirror image of the given figure when the mirror is placed at MN as shown below.

T M p 5 D c

M _____ N

Ans

✗ 1. **T M b 2 D c**

✗ 2. **T W d 2 D c**

✓ 3. **T W b 2 D c**

✗ 4. **T W b 5 D c**

Q.23 Select the figure from the options that can replace the question mark (?) and complete the given pattern.

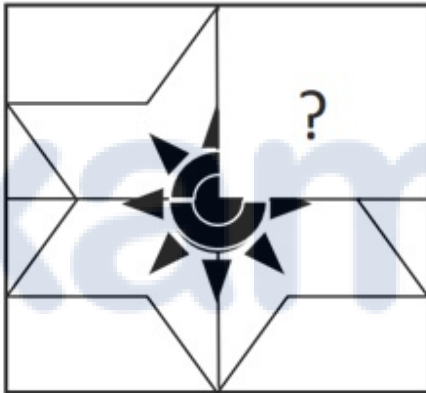

Ans

✗ 1.



✗ 2.

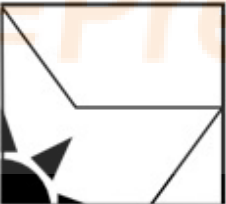

✗ 3.



✓ 4.



Q.24 Select the correct mirror image of the given combination when the mirror is placed at MN as shown below.

R d 4 7 c g
M
|
N

- Ans
- 1. g c 7 4 p Я
 - 2. g c 7 4 b Я
 - 3. g c 7 4 b Я
 - 4. g c 7 4 b Я



Prepare 50% Faster

Q.25 A square sheet of paper is folded along the dotted line successively along the directions shown and is then punched last. How would the paper look when unfolded?

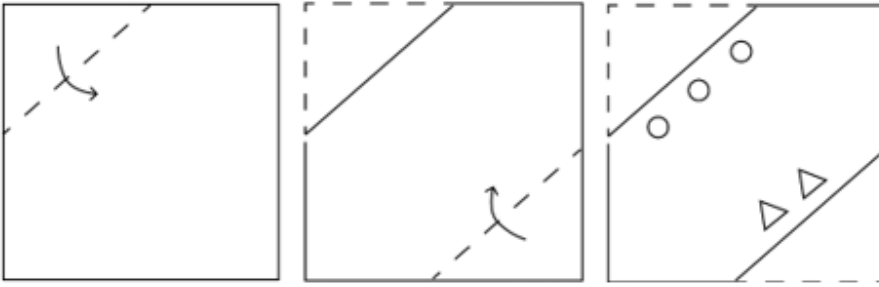

Ans

✗ 1.

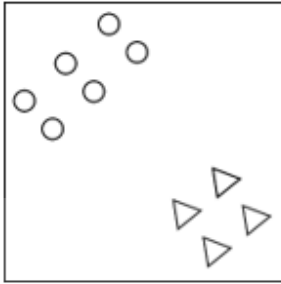

✗ 2.

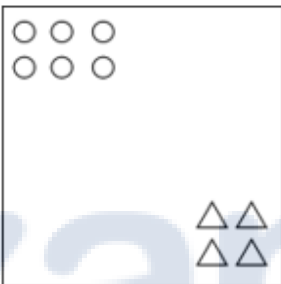

✓ 3.

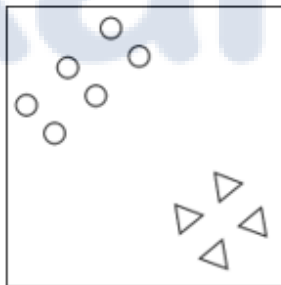

✗ 4.

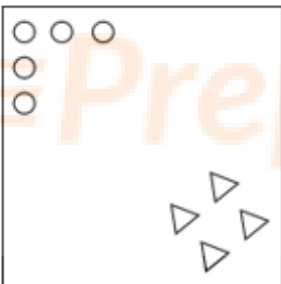

Section : Numerical Ability

Q.1 In the year 2001, the production of a factory decreased by 30%. But, in 2002, the production increased by 25%. What is the resulting change (increase or decrease) in production over these two years?

- Ans
- ✗ 1. Increase by 13.5%
 - ✓ 2. Decrease by 12.5%
 - ✗ 3. Increase by 12.5%
 - ✗ 4. Decrease by 13.5%

Q.2 Find the cost of painting a spherical ball of radius 14 cm at the rate of ₹10 per cm^2 . (Use $\pi = \frac{22}{7}$)

- Ans
- 1. ₹22,350
 - 2. ₹20,220
 - 3. ₹24,640
 - 4. ₹24,250

Q.3 A sum was invested on simple interest at a certain rate for 3 years. Had it been put at 5% higher rate, it would have fetched ₹270 more interest. The sum invested was:

- Ans
- 1. ₹1,500
 - 2. ₹2,000
 - 3. ₹1,800
 - 4. ₹1,700

Q.4 The ratio of the numbers of boys and girls in a school is 6 : 5. If 25% of the boys and 36% of the girls are scholarship holders, then the percentage of students who DO NOT get scholarship is:

- Ans
- 1. 60%
 - 2. 80%
 - 3. 70%
 - 4. 50%

Q.5 The least number which, when divided by 15, 30 and 45, leaves a remainder of 8 in each case is:

- Ans
- 1. 98
 - 2. 83
 - 3. 94
 - 4. 113

Q.6 The distance between two cities A and B is 480 km. A car starts from A at $\frac{3}{5}$ of its original speed and reaches B late by 80 minutes than its scheduled time. Find the original speed of the car (in km/h).

- Ans
- 1. 230
 - 2. 240
 - 3. 235
 - 4. 242

Q.7 Find the largest positive integer that will divide 216, 358 and 454 leaving remainder 9, 13 and 17, respectively.

- Ans
- 1. 27
 - 2. 17
 - 3. 23
 - 4. 29

Q.8 G invested ₹x in a scheme which gives 12% return. Finally, he received ₹12,000 more amount than the invested amount. How much money (in ₹) did he invest in the scheme?

- Ans
- 1. 120000
 - 2. 100000
 - 3. 80000
 - 4. 112000

Q.9 The ratio of the incomes of Ram and Ganga is 3 : 4 and the ratio of their expenditures is 2 : 3. If each person save then what is the ratio of their total income together to their total expenditure together?

- Ans**
- 1. 7 : 5
 - 2. 3 : 2
 - 3. 1 : 2
 - 4. 5 : 3

Q.10 A and B individually can finish a work in 15 and 20 days, respectively. If B starts the work on 1 October, and they work on alternate days, the work will be finished on:

- Ans**
- 1. 14 October
 - 2. 19 October
 - 3. 18 October
 - 4. 9 October

Q.11 Find the yearly rate of compound interest at which ₹2,400 amounts to ₹3,650.10 in a duration of 3 years.

- Ans**
- 1. 13%
 - 2. 12%
 - 3. 14%
 - 4. 15%

Q.12 Find the value of $[0.7 - \{4.3 - 3.6 - (6.1 - 4.7 - 2.3)\}]$.

- Ans**
- 1. $\frac{6}{10}$
 - 2. $\frac{7}{10}$
 - 3. $\frac{8}{10}$
 - 4. $-\frac{9}{10}$

Q.13 A shopkeeper marked his items with prices 65% more than their cost price and allowed a discount of 35%. Find the percentage of his profit.

- Ans**
- 1. 7.25%
 - 2. 9.50%
 - 3. 8.65%
 - 4. 10.25%

Q.14 How many metres of cloth, 6 m wide, will be required to make a conical tent, the radius of whose base is 6 m and height is 8 m? (Assume there is no wastage of material)

(Take $\pi = \frac{22}{7}$)

Ans

1. $31\frac{1}{7}$

2. $31\frac{4}{7}$

3. $31\frac{2}{7}$

4. $31\frac{3}{7}$

Q.15 The average of two numbers is 24 and the average of three other numbers is 29. What is the average of these five numbers?

Ans

1. 25

2. 28

3. 26

4. 27

Section : Computer Proficiency

Q.1 Which of the following keyboard shortcuts is used to increase the size of the selected text in MS-Word 365?

Ans

1. Ctrl + <

2. Ctrl +]

3. Ctrl + ?

4. Ctrl + +

Q.2 In MS word 365 Which of the following keyboard shortcut keys is used to open new blank documents?

Ans

1. Ctrl + O

2. Alt + O

3. Ctrl + N

4. Shift + O

Q.3 In MS Excel, which of the following is the correct cell address of the second column and third row?

Ans

1. A3

2. B3

3. 3A

4. 3B

Q.4 What does the cell address 'C10' represent in an electronic spreadsheet?

Ans

1. The cell in the twelfth column and the third row

2. The cell in the tenth column and the third row

3. The cell in the third column and the tenth row

4. The cell in the third column and the twelfth row

Q.5 Which of the following is an option present in Paragraph Formatting in MS Word 365?

- Ans**
- 1. Replace
 - 2. Line spacing
 - 3. Find
 - 4. Save

Q.6 Which of the following is a type of internet connection that uses a telephone line for data transmission?

- Ans**
- 1. Broadband
 - 2. Fibre optic
 - 3. Satellite
 - 4. Dial up

Q.7 Which of the following alignments will give your text straight edges on both sides of the paragraph and extends each line of your text to the left and right margins in MS Word 365?

- Ans**
- 1. Right alignment
 - 2. Left alignment
 - 3. Center
 - 4. Justify

Q.8 Among the following, under which tab will you find the Start Mail Merge in the Microsoft Office Professional Plus 2016?

- Ans**
- 1. Insert
 - 2. Home
 - 3. References
 - 4. Mailings

Q.9 Which of the following is a secret string of characters used to verify the identity of a user during the authentication process?

- Ans**
- 1. Website
 - 2. Domain name
 - 3. Username
 - 4. Password

Q.10 Which of the following statements is correct about the row height of the cell in a spreadsheet in MS-Excel 2010?

- Ans**
- 1. Upper and lower bounds for row heights are 409 and 0, respectively.
 - 2. Upper and lower bounds for row heights are 609 and 0, respectively.
 - 3. Upper and lower bounds for row heights are 709 and 0, respectively.
 - 4. Upper and lower bounds for row heights are 509 and 0, respectively.

Constable Executive Male and Female in Delhi Police Examination 2023

Exam Date	22/11/2023
Exam Time	12:00 PM - 1:30 PM
Subject	Constable Executive Male and Female in Delhi Police Examination 2023

Section : General Knowledge

Q.1 Which of the following is NOT one of the several approaches of microfinance delivery mechanisms in India?

- Ans**
- 1. Microfinance institutions- Credit Lending Models
 - 2. Conventional weaker-section lending by banks
 - 3. Cheap subsidised credit
 - 4. Self-help-group – bank linkage programme

Q.2 To which genus does the nematode parasite called hookworm belong, which usually spreads through infected soil?

- Ans**
- 1. Pheretima
 - 2. Fasciola
 - 3. Ancylostoma
 - 4. Hirudinaria

Q.3 'The Adventures of Huckleberry Finn' was written by which of the following authors?

- Ans**
- 1. Robert Louis Stevenson
 - 2. Mark Twain
 - 3. Jerome K Jerome
 - 4. Jane Austen

Q.4 Who among the following emphasised and propagated that "the Vedanta is the religion of all and not of the Hindus alone"?

- Ans**
- 1. Swami Dayanand Saraswati
 - 2. Ishwar Chandra Vidyasagar
 - 3. Raja Ram Mohan Roy
 - 4. Swami Vivekanand

Q.5 Minati Mishra was conferred the Padma Shree for her contribution to which form of dance?

- Ans**
- 1. Bihu
 - 2. Chhau
 - 3. Odissi
 - 4. Sattriya

Q.6 Which of the following was one of the five states formed by breaking up the Bahmani kingdom?

- Ans**
- 1. Karur
 - 2. Madras
 - 3. Golkonda
 - 4. Hyderabad

Q.7 Who among the following is called the 'Bhajan Samrat' of India?

- Ans**
- 1. Sanjeev Abhyankar
 - 2. Dayanand Prajapati
 - 3. Vishnu Bharnagar
 - 4. Anup Jalota

Q.8 Which of the following is a popular festival celebrated in the state of Bihar?

- Ans**
- 1. Me-Dam-Me-Phi
 - 2. Harela
 - 3. Ali-Ai-Ligang
 - 4. Sama Chakeva

Q.9 The Ghoomar dance of Rajasthan was originally performed by which tribal community?

- Ans**
- 1. Kanjar
 - 2. Mina
 - 3. Bhil
 - 4. Kathodi

Q.10 Which of the following schemes aims to provide generic medicines at reasonable prices to the citizen of the country?

- Ans**
- 1. Janani Shishu Suraksha Karyakaram
 - 2. Pradhan Mantri Bharatiya Janaushadhi Pariyojana
 - 3. Mission Indradhanush
 - 4. Universal Immunisation Programme

Q.11 Dehing Patkai festival is the festival to celebrate the rich culture of which of the following Indian states?

- Ans**
- 1. Nagaland
 - 2. Tripura
 - 3. Assam
 - 4. Sikkim

Q.12 Which of the following dances was traditionally performed by male monks in monasteries?

- Ans**
- 1. Sattriya
 - 2. Kathakali
 - 3. Odissi
 - 4. Kuchipudi

Q.13 Devadasi National Award is given at the dance festival held at the pilgrim centre in the state of _____.

- Ans**
- 1. Kerala
 - 2. West Bengal
 - 3. Tamil Nadu
 - 4. Odisha

Q.14 Under which of the following Acts can supreme court initiate International Commercial Arbitration?

- Ans**
- 1. Arbitration and Conciliation Act, 1996
 - 2. International Arbitration Act, 2012
 - 3. Arbitration and Cancellations Act, 2004
 - 4. United Nations Act on justice, 2015

Q.15 Consider the following methods adopted by the government to protect goods produced in India from imports.
(i) Heavy taxes were levied on imported goods
(ii) The maximum limit on the imports of a commodity by a domestic user was fixed
Choose the correct answer.

- Ans**
- 1. Both (i) and (ii) are true
 - 2. Both (i) and (ii) are false
 - 3. Only (ii) is true
 - 4. Only (i) is true

Q.16 Who among the following novelists has written 'A Suitable Boy'?

- Ans**
- 1. Vikram Seth
 - 2. Chetan Bhagat
 - 3. Arundhati Roy
 - 4. Aravind Adiga

Q.17 In the year 1904, who formed a secret organisation of revolutionaries named Abhinav Bharat?

- Ans**
- 1. Ajit Singh
 - 2. Vinayak Damodar Savarkar
 - 3. Lala Har Dayal
 - 4. Subhash Chandra Bose

Q.18 Which National Waterway is associated with the Brahmaputra River?

- Ans**
- 1. National Waterway 1
 - 2. National Waterway 5
 - 3. National Waterway 3
 - 4. National Waterway 2

Q.19 Which of the following states had the least decadal growth in literacy rate, as per census 2011?

- Ans**
- 1. Mizoram
 - 2. Tripura
 - 3. Goa
 - 4. Kerala

Q.20 Under which of the following Articles of the Constitution of India does the Governor of Arunachal Pradesh have special responsibility with respect to law and order and in discharge of his functions in relation thereto?

- Ans**
- 1. Article 371 G
 - 2. Article 371 A
 - 3. Article 371 H
 - 4. Article 371 D

Q.21 The Red Fort was commissioned by which of these emperors?

- Ans**
- 1. Jahangir
 - 2. Qutb-ud-din Bakhtiyar Khilji
 - 3. Shah Jahan
 - 4. Mohammad Bin Tughlaq

Q.22 Simuka was the founder of which of the following dynasties of the post Mauryan era?

- Ans**
- 1. Kanva
 - 2. Satavahana
 - 3. Parthians
 - 4. Kushana

Q.23 Which Article of the Indian Constitution mentions that it shall be the duty of every citizen of India to have compassion for living creatures?

- Ans**
- 1. 51 A (g)
 - 2. 51 A (j)
 - 3. 51 A (h)
 - 4. 51 A (i)

Q.24 In which part of the Constitution of India is the procedure for amendments in the Constitution laid down?

- Ans**
- 1. Part XXI
 - 2. Part XX
 - 3. Part X
 - 4. Part XV

Q.25 According to the census of India 2011, what was the literacy rate of Tamil Nadu?

- Ans**
- 1. 82.34%
 - 2. 80.09%
 - 3. 81.42%
 - 4. 82.80%

Q.26 What is the air temperature at tropopause over the equator?

- Ans**
- 1. -80°C
 - 2. -70°C
 - 3. -60°C
 - 4. -50°C

Q.27 Which of the following is involved in the movement of lava over or towards the surface of the earth?

- Ans**
- 1. Volcanism
 - 2. Weathering
 - 3. Diastrophism
 - 4. Exogenic process

Q.28 Green Revolution is an example of:

- Ans**
- 1. how technology can bring revolutionary changes in agricultural output
 - 2. how green GDP can be increased with the agricultural revolution
 - 3. how international trade ban can bring changes in the agriculture produce
 - 4. how the service sector can bring about a revolution in India

Q.29 What is the standard distance for males in a hurdle event?

- Ans**
- 1. 110 m and 400 m
 - 2. 100 m and 400 m
 - 3. 120 m and 410 m
 - 4. 110 m and 410 m

Q.30 The Lakshmana temple of Khajuraho, dedicated to Lord Vishnu, is an example of which style of temple architecture?

- Ans**
- 1. Dravidian
 - 2. Odisha
 - 3. Nagara
 - 4. Vesara

Q.31 Which common long-term infection develops when bacteria in the mouth metabolise sugars to produce acids that demineralise the hard tissues of teeth?

- Ans**
- 1. Dental caries
 - 2. Oro-dental trauma
 - 3. Cleft palate
 - 4. Oral thrush

Q.32 The Rigveda Samhita comprises of _____ books.

- Ans**
- 1. 7
 - 2. 11
 - 3. 13
 - 4. 10

Q.33 Who advises the Governor with respect to proroguing of the session of the State Legislature?

- Ans**
- 1. Senior Member of the House
 - 2. Deputy Speaker
 - 3. Chief Minister
 - 4. Speaker

Q.34 Mame Khan, an Indian folk singer known for his Sufi and folk music performances, is from the state of _____.

- Ans**
- 1. Rajasthan
 - 2. Punjab
 - 3. Gujarat
 - 4. Assam

Q.35 In which of the following States was the 44th Chess Olympiad held?

- Ans**
- 1. Andhra Pradesh
 - 2. Tamil Nadu
 - 3. Karnataka
 - 4. Kerala

Q.36 According to Census of India 2011, which of the following states has a population of more than 10 crores?

- Ans**
- 1. Maharashtra
 - 2. Andhra Pradesh
 - 3. West Bengal
 - 4. Rajasthan

Q.37 Globalisation, by connecting countries, shall result in _____.

- Ans**
- 1. lesser competition among producers
 - 2. greater competition among producers
 - 3. price enhancement by producers
 - 4. no change in competition among producers

Q.38 Becquerel, which is equal to one disintegration per second (dps) is represented by which symbol?

- Ans**
- 1. Br
 - 2. BI
 - 3. Bq
 - 4. Bc

Q.39 Which of the following is a book written by Jyotirao Phule in 1873?

- Ans
- 1. Last Among Equals
 - 2. Gulamgiri
 - 3. Jati ka Vinash
 - 4. Tribe Caste and Society

Q.40 Since which year has the Census become a regular ten yearly exercise in India?

- Ans
- 1. 1881
 - 2. 1961
 - 3. 1951
 - 4. 1851

Q.41 Which of the following states is related to Gatka, which was inducted into the 37th National Games?

- Ans
- 1. Punjab
 - 2. Uttarakhand
 - 3. Uttar Pradesh
 - 4. Haryana

Q.42 What is the spread of living pteridophytes to narrow geographical regions?

- Ans
- 1. Limited and unrestricted
 - 2. Unlimited and restricted
 - 3. Unlimited and unrestricted
 - 4. Limited and restricted

Q.43 Tax rates on higher income groups have been increased resulting in _____.

- Ans
- 1. economic growth
 - 2. reducing inequalities of income and wealth
 - 3. economic stability
 - 4. reducing regional disparities

Q.44 The Sikhs under Guru Hargobind defeated the Mughals four times during the reign of _____.

- Ans
- 1. Aurangzeb
 - 2. Jahangir
 - 3. Shah Jahan
 - 4. Akbar

Q.45 Which of the following words is not part of Article 15 of the Indian Constitution as far as grounds of discrimination are concerned?

- Ans
- 1. Religion
 - 2. Race
 - 3. Profession
 - 4. Caste

Q.46 Which of the following Articles of the Constitution of India mentions that Parliament by law can form a new State by separation of territory from any state or by uniting any territory to a part of any State?

- Ans
- 1. Article 9
 - 2. Article 3
 - 3. Article 5
 - 4. Article 7

Q.47 Which region of India is known for the unique Shola forests?

- Ans
- 1. Thar Desert
 - 2. Western Ghats
 - 3. Deccan Plateau
 - 4. Eastern Himalayas

Q.48 Who among the following was appointed as the first minister of the Ministry of Disinvestment during the tenure of the Vajpayee Government?

- Ans
- 1. Jaswant Singh
 - 2. George Fernandes
 - 3. Arun Shourie
 - 4. Yashwant Sinha

Q.49 Which of the following channels is NOT a part of six communication mail channels to facilitate quick delivery of mails in large towns and cities of India?

- Ans
- 1. Periodical channel
 - 2. Business channel
 - 3. Weekly channel
 - 4. Metro channel

Q.50 Which of the following topped the medals tally, winning 61 gold medals in the National Games-2022?

- Ans
- 1. Services Sports Control Board
 - 2. Haryana
 - 3. Kerala
 - 4. Maharashtra

Section : Reasoning

Q.1 Which two signs should be interchanged to make the following equation correct?

$$32 \times 5 + 12 \div 4 - 18 = 29$$

- Ans
- 1. + and ×
 - 2. - and ×
 - 3. ÷ and ×
 - 4. - and +

Q.2 Select the figure from the options that can replace the question mark (?) and complete the given pattern.

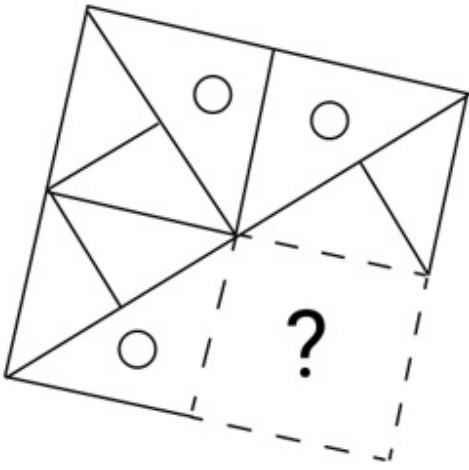

Ans

✗ 1.

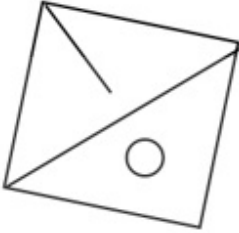

✗ 2.

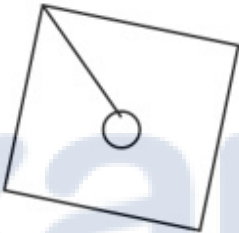

✓ 3.

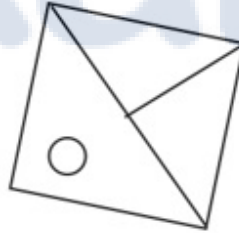

✗ 4.

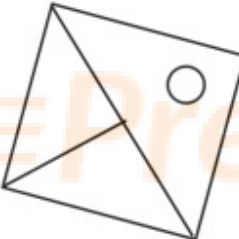

Q.3 Which of the following option figures will complete the pattern in the figure given below?



Ans

- ✓ 1.
- ✗ 2.
- ✗ 3.
- ✗ 4.

Q.4 Select the correct mirror image of the given combination when the mirror is placed at 'PQ' as shown below.



Ans

- ✗ 1.
- ✗ 2.
- ✓ 3.
- ✗ 4.

Q.5 Two statements are given followed by two conclusions numbered I and II. Assuming the statements to be true, even if they seem to be at variance from commonly known facts, decide which of the conclusions logically follow(s) from the statements.

Statements:

All Tears are Salts.

Some Tears are Crocodiles.

Conclusions:

I. All Crocodiles are Tears.

II. All Crocodiles are Salts.

- Ans**
- 1. Neither conclusion I nor II follows.
 - 2. Only conclusion II follows.
 - 3. Both conclusions I and II follow.
 - 4. Only conclusion I follows.

Q.6 Select the number from among the given options that can replace the question mark (?) in the following series.
8.8, ?, 7.3, 6.7, 6.2, 5.8

- Ans**
- 1. 8.1
 - 2. 8
 - 3. 7.9
 - 4. 8.2

Q.7 Select the option that is related to the third term in the same way as the second term is related to the first term and the sixth term is related to the fifth term.
13 : 169 :: 9 : ? :: 21 : 441

- Ans**
- 1. 27
 - 2. 729
 - 3. 81
 - 4. 243

Q.8 Select the option that represents the letters that, when sequentially placed from left to right in the blanks below, will complete the letter series.

A _ _ PS _ LNP _ A _ N _ S _ LNP _

- Ans**
- 1. NLASLPAS
 - 2. LNASLPAS
 - 3. LNASPLAS
 - 4. LNASLPSA

Q.9 Select the set in which the numbers are related in the same way as are the numbers of the following sets.

(NOTE: Operations should be performed on the whole numbers, without breaking down the numbers into its constituent digits. E.g. 13 – Operations on 13 such as adding/deleting/multiplying etc. to 13 can be performed. Breaking down 13 into 1 and 3 and then performing mathematical operations on 1 and 3 is not allowed)

(2, 14, 3), (4, 28, 5)

- Ans**
- 1. (7, 39, 2)
 - 2. (7, 22, 2)
 - 3. (7, 37, 2)
 - 4. (7, 45, 2)

Q.10 Select the option that is related to the fifth letter-cluster in the same way as the second letter-cluster is related to the first letter-cluster and the fourth letter-cluster is related to the third letter-cluster.

HUGE : IJWI :: BEAM : QDGC :: RIDE : ?

- Ans**
- 1. IGLS
 - 2. IHKR
 - 3. IGKS
 - 4. IGKR

Q.11 A paper is folded and cut as shown below. How will it appear when unfolded?

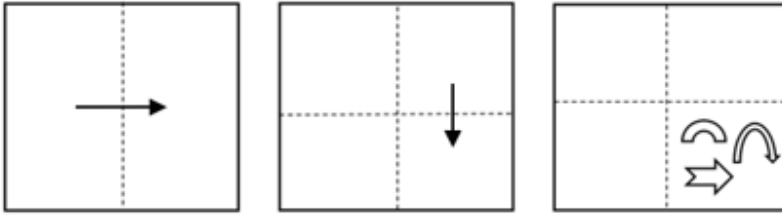

Ans

X 1.

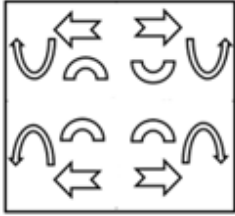

X 2.

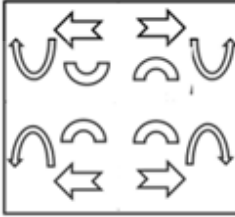

X 3.

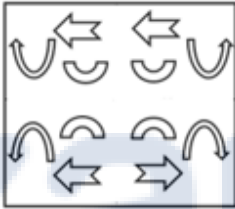

✓ 4.

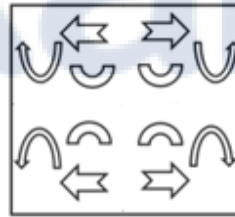

Prepare 50% Faster

Q.12 Which figure should replace the question mark (?) if the series were to be continued?

3	X	Y	6	3	0	8	X	D	Y	8	6	?
	8			Y			O			D		
6	D	O	D	X	8	Y	3	6	3	X	O	

Ans

X 1.

O	X	3
	Y	
6	8	D

X 2.

O	X	3
	8	
6	D	Y

✓ 3.

O	X	3
	6	
D	8	Y

X 4.

3	X	Y
	8	
O	D	6

Q.13 Select the figure from the given options that will replace the question mark (?) in the figure given below to complete the pattern so that the final image is symmetrical.

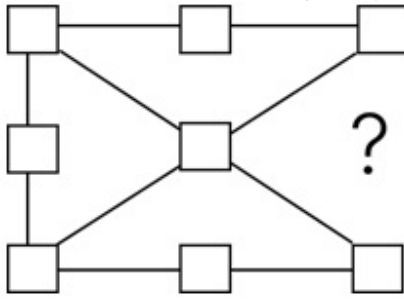

Ans

- ✗ 1.
- ✓ 2.
- ✗ 3.
- ✗ 4.

Q.14 Select the correct mirror image of the given figure when the mirror is placed at PQ as shown below.

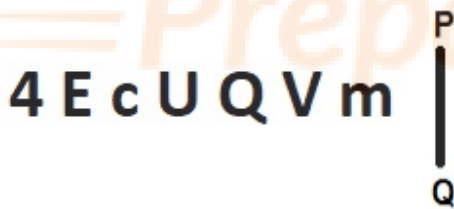

Ans

- ✓ 1. **m V Q U c E 4**
- ✗ 2. **m V Q U c E 4**
- ✗ 3. **m V Q U c E 4**
- ✗ 4. **m V Q U c E 4**

Q.15 Which figure from the given options would replace the question mark (?) if the following figure series were to be continued?

S O R A	Z R O E	A S Z R	S O E A	Z R A A	O E S O	R Z A O	?
------------------	------------------	------------------	------------------	------------------	------------------	------------------	---

Ans

✗ 1.

O	E
A	
Z	
S	R

✗ 2.

A	R
S	
E	
O	Z

✓ 3.

O	S
Z	
A	
E	R

✗ 4.

O	A
S	
E	
Z	R

Q.16 P, Q, R, S and T are five friends sitting in a straight line facing North. P sits at the extreme right end. T sits to the left of S but is not at the extreme left end. R is the immediate neighbour of P. Who sits at the extreme left end of the line?

- Ans
- 1. Q
 - 2. S
 - 3. R
 - 4. P

Q.17 In a certain code language, 'BEAM' is written as 'BAFL' and 'HUGE' is written as 'FFIT'. How will 'ZERO' be written in that language?

- Ans
- 1. FNSY
 - 2. DNSA
 - 3. DSNA
 - 4. FSNY

Q.18 Select the correct mirror image of the given combination when the mirror is placed at 'XY' as shown below



- Ans
- 1. B B I L L I E N T
 - 2. T N E I L L I R B
 - 3. T N E I L L I R B
 - 4. T N E I L L I R B

Q.19 1, 2, 3, 4, 5 and 6 are written on different faces of a dice. Three different positions of the same dice are shown below. Find the number on the face opposite to the one showing '1'.

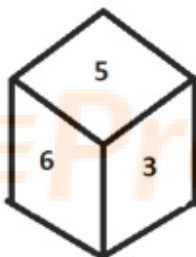

figure 1

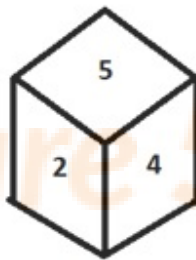

figure 2

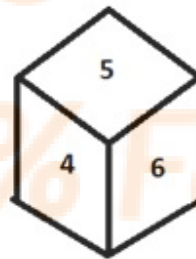
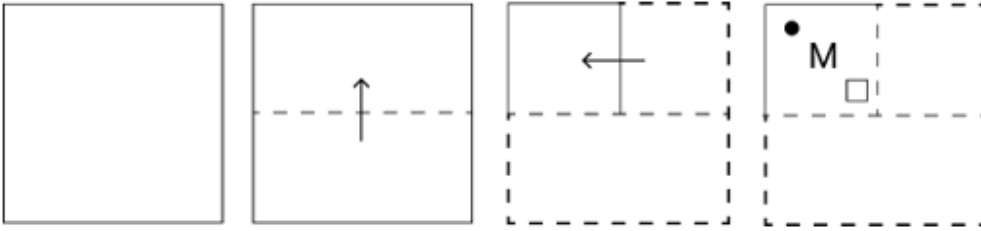

figure 3

- Ans
- 1. 5
 - 2. 6
 - 3. 4
 - 4. 2

Q.21 A square sheet of paper is folded along the dotted line successively along the directions shown and is then punched last. How would the paper look when unfolded?



Ans

✗ 1.

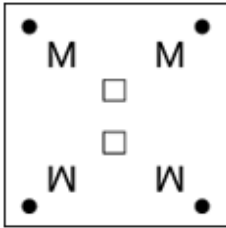

✓ 2.

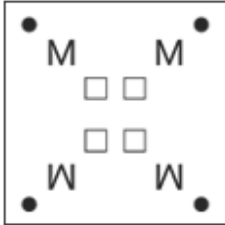

✗ 3.

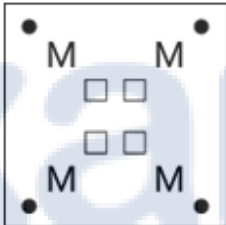

✗ 4.

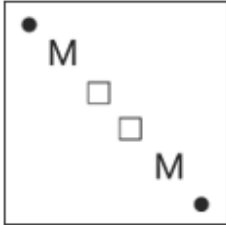

Q.22 Which two signs should be interchanged to make the following equation correct?

$$39 + 4 \div 5 - 57 \times 3 = 40$$

Ans ✓ 1. ÷ and ×

✗ 2. + and ÷

✗ 3. - and ×

✗ 4. - and +

Q.23 Select the option figure that will replace the question mark (?) in the figure given below to complete the pattern.

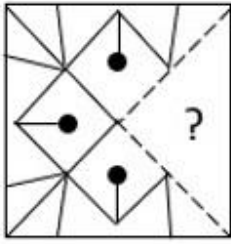

Ans

X 1.

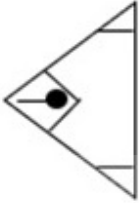

X 2.

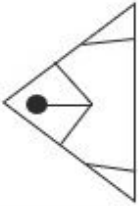

✓ 3.

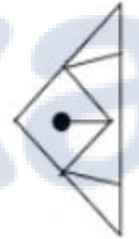

X 4.



Q.24 Select the correct mirror image of the given figure when the mirror is placed at MN as shown below.

B 7 t y u 9 K

M ————— N

Ans

X 1.

B 7 t λ n 6 K

✓ 2.

B 7 f λ n ə K

X 3.

B 7 f λ n ə K

X 4.

B 7 f λ n ə K

Q.25 How many triangles are there in the given figure?

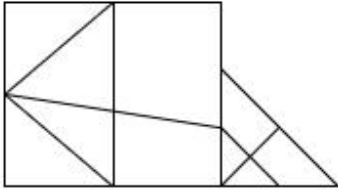

- Ans
- 1. 11
 - 2. 12
 - 3. 8
 - 4. 6

Section : Numerical Ability

Q.1 A 220 m long train, travelling at a speed of 99 km/h, completely crosses another train coming from the opposite direction at a speed of 81 km/h in 9 seconds. Find the length of the second train (in metres).

- Ans
- 1. 225
 - 2. 220
 - 3. 240
 - 4. 230

Q.2 If p and q are two prime numbers, then the average of p and q is:

- Ans
- 1. $p + q$
 - 2. $(p + q)/2$
 - 3. $p - q$
 - 4. $(p - q)/2$

Q.3 On selling an item for ₹1,500, a shopkeeper loses 20%. For what amount should he sell it to gain 10%?

- Ans
- 1. ₹2,100
 - 2. ₹2,000
 - 3. ₹2,162.50
 - 4. ₹2,062.50

Q.4 A sphere is 10 cm in diameter. Find the volume of the sphere in cubic metres?

- Ans
- 1. $\frac{\pi}{6} \times 10^{-2}$
 - 2. $\frac{\pi}{6} \times 10^{-3}$
 - 3. $\frac{\pi}{8} \times 10^{-3}$
 - 4. $\frac{\pi}{8} \times 10^{-2}$

Q.5 The HCF of 204, 507 and 174 is:

- Ans
- 1. 13
 - 2. 2
 - 3. 3
 - 4. 17

Q.6 Three numbers are in the ratio 4: 5: 6 and their LCM is 180. Their HCF is:

- Ans
- 1. 1.5
 - 2. 2
 - 3. 3
 - 4. 4

Q.7 A mobile phone is available for ₹39,300 cash payment, or for ₹7,450 cash down payment and three equal yearly instalments. If the shopkeeper charges interest at the rate of 20% per annum, compounded annually, what is the amount of instalment (in ₹)?

- Ans
- 1. 16240
 - 2. 14060
 - 3. 15000
 - 4. 15120

Q.8 In an election between two candidates, 80% of the voters cast their votes, out of which 5% of the votes were declared invalid. A candidate got 5,700 votes, which were 75% of the total valid votes. Find the total number of voters enrolled in that election.

- Ans
- 1. 9500
 - 2. 9000
 - 3. 10000
 - 4. 12000

Q.9 The ratio of two numbers is 5:7 and their difference is 48. The smaller of the two numbers is:

- Ans
- 1. 140
 - 2. 120
 - 3. 100
 - 4. 80

Q.10 Rajneesh decided to invest in gold every month. He buys gold worth ₹65,000. He gets a rebate of 8% on it. After getting the rebate, he pays tax at the rate of 10%. Next month, he buys ₹70,000 with a rebate of 10% and tax 12%. What is the percentage change in his investment from the first month to the second month?

- Ans
- 1. Decrease; between 7 and 8 %
 - 2. Increase; between 5 and 6%
 - 3. Decrease; between 5 and 6 %
 - 4. Increase; between 7 and 8%

Q.11 At what rate per cent per annum will a sum of money double itself on simple interest in 7 years?

- Ans
- 1. $14\frac{1}{7}\%$
 - 2. $14\frac{4}{7}\%$
 - 3. $14\frac{2}{7}\%$
 - 4. $7\frac{1}{14}\%$

Q.12 A can do a work in 30 days and B can do the same work in 40 days. They work together for 8 days and then B leaves the work. In how many days will A finish the remaining work?

- Ans
- 1. 14
 - 2. 17
 - 3. 16
 - 4. 15

Q.13 A dealer fixed the price of an article 24% above the cost of production. While selling it, he allows a discount of 15 fixed price and makes a profit of ₹27. Find the cost of production of the article.

- Ans**
- 1. ₹700
 - 2. ₹500
 - 3. ₹600
 - 4. ₹400

Q.14 In how many ways can 480 be written as the product of two numbers which are coprime to each other?

- Ans**
- 1. 1
 - 2. 4
 - 3. 3
 - 4. 2

Q.15 Find the volume (in cm^3) of the hemisphere whose diameter measures 14 cm
(Use $\pi = \frac{22}{7}$).

- Ans**
- 1. $\frac{2,651}{3}$
 - 2. $\frac{2,615}{3}$
 - 3. $\frac{2,156}{3}$
 - 4. $\frac{2,516}{3}$

Section : Computer Proficiency

Q.1 In MS word 365 What do you mean by hamburger menu?

- Ans**
- 1. It saves the document in the file.
 - 2. It prints the document in the file.
 - 3. It deletes the document in the file.
 - 4. It hides the traditional file menu.

Q.2 Which of the following is the purpose of the 'Cell Padding' property in a table in MS Word?

- Ans**
- 1. It adds a border around each cell
 - 2. It adjusts the spacing between cells and their content
 - 3. It merges adjacent cells
 - 4. It changes the font size within the cells

Q.3 What is the primary purpose of an email client?

- Ans**
- 1. To edit photos
 - 2. To create spreadsheets
 - 3. To play video games
 - 4. To read and send emails

Q.4 Which of the following internet services is a secure connection over the internet that allows users to connect to a network from a remote location?

- Ans**
- 1. VoIP
 - 2. Web browsing
 - 3. Email
 - 4. VPN

Q.5 In spreadsheet software, which formula can be used to find the largest value in a range of cells?

- Ans**
- 1. MIN()
 - 2. MAX()
 - 3. COUNT()
 - 4. SUM()

Q.6 Which of the following does the 'Bold' formatting option typically do to text in an MS Word 365, document?

- Ans**
- 1. Make the text larger
 - 2. Change the font style to italics
 - 3. Change the text colour
 - 4. Make the text darker and thicker

Q.7 The 'Sort & Filter' group is available under which of the following tabs in MS Excel 365?

- Ans**
- 1. Insert
 - 2. Home
 - 3. Data
 - 4. View

Q.8 In MS Word 365, which group within the Home tab contains the alignment options?

- Ans**
- 1. Styles
 - 2. Paragraph
 - 3. Font
 - 4. Editing

Q.9 Which of the following is a function in MS Excel 365 that returns the sum of the values in a range of cells?

- Ans**
- 1. AVERAGE
 - 2. SUM
 - 3. MAX
 - 4. COUNT

Q.10 What is the purpose of the 'Print Preview' feature in Microsoft Word 365 ?

- Ans**
- 1. It provides suggestions for improving grammar and spelling.
 - 2. It provides a preview of how the document will look when printed.
 - 3. It allows you to insert images and graphics.
 - 4. It allows you to edit text and formatting.

Constable Executive Male and Female in Delhi Police Examination 2023

Exam Date	22/11/2023
Exam Time	3:00 PM - 4:30 PM
Subject	Constable Executive Male and Female in Delhi Police Examination 2023

Section : General Knowledge

Q.1 Who among the following Bharatanatyam and Kuchipudi dancers received the Padma Vibhushan award in the year 2016?

- Ans**
- 1. Yamini Krishnamurthi
 - 2. Aparna Satheesan
 - 3. Alarmel Valli
 - 4. Padma Subrahmanyam

Q.2 Consider the following statements with respect to the limitations of the barter exchange system.

- (i) Lack of standard of deferred payment
 - (ii) Sufficient double coincidence of wants
 - (iii) Lack of store of value
- Choose the correct answer.

- Ans**
- 1. Only (ii) is true
 - 2. Only (iii) is true
 - 3. Only (i) is true
 - 4. Both (i) and (iii) are true

Q.3 When is Guru Nanak Jayanti celebrated in India as per the Hindu lunar calendar?

- Ans**
- 1. Kartika Purnima
 - 2. Kartika Amavasya
 - 3. Paush Amavasya
 - 4. Paush Purnima

Q.4 Which of the following Articles of the Constitution of India deals with the National Commission for Scheduled Castes?

- Ans**
- 1. Article 336
 - 2. Article 338
 - 3. Article 337
 - 4. Article 335

Q.5 Who among the following fought the Mughal emperor Babur in 1527 at Khanwa?

- Ans**
- 1. Rana Raj Singh
 - 2. Rana Amar Singh
 - 3. Rana Pratap
 - 4. Rana Sanga

Q.6 Aryabhata is believed to be one of the greatest astronomers of the:

- Ans**
- 1. Vardhan Period
 - 2. Mauryan Period
 - 3. Gupta period
 - 4. Pallava period

Q.7 In which of the following years was the SFURTI scheme launched by the Ministry of Micro Small and Medium Ent

- Ans
- 1. 2009
 - 2. 2005
 - 3. 2007
 - 4. 2003

Q.8 What are the compounds in food that induce the growth or activity of beneficial gut microorganisms called?

- Ans
- 1. Abiotic
 - 2. Prebiotics
 - 3. Postbiotics
 - 4. Antibiotics

Q.9 _____ means avoiding imports of goods which could be produced in India.

- Ans
- 1. Equity
 - 2. Self-reliance
 - 3. Modernisation
 - 4. Economic growth

Q.10 Which of the following pairs of cities is connected by Sher-Shah Suri Marg?

- Ans
- 1. Mumbai-Bengaluru
 - 2. Delhi-Mumbai
 - 3. Delhi-Amritsar
 - 4. Delhi-Jaipur

Q.11 Chandragupta II got his daughter married into which of the following dynasties?

- Ans
- 1. Pushyabhuti dynasty
 - 2. Shunga dynasty
 - 3. Naga dynasty
 - 4. Vakataka dynasty

Q.12 Which of the following churches is NOT located in Goa?

- Ans
- 1. Santa Cruz Basilica
 - 2. Reis Magos Church
 - 3. Mae De Deus Church
 - 4. Basilica of Bom Jesus

Q.13 What was the subject under investigation for setting up the Hunter commission in 1882?

- Ans
- 1. Famine
 - 2. Education
 - 3. Industry
 - 4. Agriculture

Q.14 Who launched the official jersey of the fourth Khelo India Youth Games?

- Ans
- 1. Nisith Pramanik
 - 2. Narendra Modi
 - 3. Anurag Thakur
 - 4. Amit Shah

Q.15 Who among the following is NOT a shehnai player?

- Ans
- 1. Ali Ahmad Hussain
 - 2. Krishna Ram Chaudhary
 - 3. Bismillah Khan
 - 4. N Ramani

Q.16 Which of the following countries will host the ICC T20 Men's Cricket World Cup 2024?

- Ans
- 1. West Indies and USA
 - 2. Australia and New Zealand
 - 3. West Indies and Canada
 - 4. India and Sri Lanka

Q.17 The English novel 'Heart of Darkness' was written by which of the following authors?

- Ans
- 1. Joseph Conrad
 - 2. Charles Dickens
 - 3. Edgar Allen Poe
 - 4. Herman Melville

Q.18 In the seventeenth century, Peter Mundy, a foreign traveller from _____ visited India.

- Ans
- 1. Italy
 - 2. Germany
 - 3. England
 - 4. France

Q.19 In an ecosystem, which of the following is/are autotrophs?

- Ans
- 1. Earthworms
 - 2. Plants
 - 3. Fishes
 - 4. Sunlight

Q.20 Which are the most explosive of the earth's volcanoes?

- Ans
- 1. Composite
 - 2. Mid ocean ridge
 - 3. Caldera
 - 4. Flood basalt

Q.21 Who among the following Russian political leaders visited India as part of Republic Day celebrations in the year 2007?

- Ans
- 1. Boris Yeltsin
 - 2. Dmitry Medvedev
 - 3. Mikhail Mishustin
 - 4. Vladimir Putin

Q.22 On the basis of Total Population (2011), arrange the following states in descending order?

- A) West Bengal
B) Maharashtra
C) Bihar

- Ans
- 1. A, C, B
 - 2. A, B, C
 - 3. B, A, C
 - 4. B, C, A

Q.23 'Below the Poverty Line' Census was done in the year _____ for the Eighth Five Year Plan.

- Ans
- 1. 1992
 - 2. 1990
 - 3. 1989
 - 4. 1993

Q.24 Which of the following organisations was given statutory power in 1992?

- Ans
- 1. LIC
 - 2. IRDA
 - 3. SEBI
 - 4. RBI

Q.25 Who among the following was the founder and director of Darpana Academy of Performing Arts?

- Ans
- 1. Kumari Kamala
 - 2. Rukmini Devi Arundel
 - 3. Yamini Krishnamurthy
 - 4. Mrinalini Sarabhai

Q.26 Which of the following writs are issued only against judicial and quasi-judicial bodies?

- Ans
- 1. Prohibition and Quo-Warranto
 - 2. Mandamus and Certiorari
 - 3. Prohibition and Certiorari
 - 4. Habeas Corpus and Mandamus

Q.27 Which of the following provisions of the Constitution of India requires a special majority of the Parliament and consent of States?

- Ans
- 1. Quorum in Parliament
 - 2. Abolition and creation of legislative councils
 - 3. Election of the President
 - 4. Directive Principles of State Policy

Q.28 Two compounds with the same molecular formula but different structures are known as:

- Ans
- 1. allotropes
 - 2. structural isomers
 - 3. valencies
 - 4. isotopes

Q.29 हैदराबाद में चारमीनार एक _____ विशाल संरचना है जिसमें चार मीनारें हैं।

- Ans
- 1. वर्गाकार
 - 2. बेलनाकार
 - 3. गुंबद के आकार की
 - 4. आयताकार

Q.30 मुद्रा की छपाई के माध्यम से केंद्रीय बैंक द्वारा जुटाए गए राजस्व को _____ कहा जाता है।

- Ans
- 1. राजकोषीय बैलेंस (Fiscal Balance)
 - 2. लाभ (Profit)
 - 3. टंकण प्रलाभ (Seigniorage)
 - 4. खजाना (Treasury)

Q.31 Who among the following Muslim social reformers propagated his ideas through a magazine 'Tahdib-ul-Akhlaq'?

- Ans
- 1. Rashid Ahmad
 - 2. Syed Ahmed Khan
 - 3. Muhammad Qasim
 - 4. Ghulam Ahmed

Q.32 Which of the following universities stood first at the Khelo India University Games-2021?

- Ans
- 1. University of Mumbai
 - 2. University of Kerala
 - 3. Jain University
 - 4. Jawaharlal Nehru University

Q.33 In which of the following years did the peasant movement in Bardoli take place?

- Ans
- 1. 1928
 - 2. 1918
 - 3. 1934
 - 4. 1916

Q.34 Pandit Birju Maharaj was a legendary _____ dancer, who opened his dance school 'Kalashram' in New Delhi.

- Ans
- 1. Odissi
 - 2. Kathak
 - 3. Kathakali
 - 4. Bharatanatyam

Q.35 How many types of writs can be issued to protect the Fundamental Rights?

- Ans
- 1. 2
 - 2. 4
 - 3. 5
 - 4. 3

Q.36 महादेश रचना संबंधी (epieirogenic) प्रक्रिया क्या है?

- Ans
- 1. इसमें भू-पर्पटी के बड़े हिस्से का उत्थान या आवलन शामिल है।
 - 2. इसमें चट्टानों का अपेक्षाकृत अल्प संचलन शामिल है।
 - 3. इसमें भूपर्पटी पट्टिका का क्षैतिज संचलन शामिल है।
 - 4. इसमें जल का अपेक्षाकृत अल्प संचलन शामिल है।

Q.37 In how many phases was the 2011 Census conducted in India?

- Ans
- 1. Four
 - 2. One
 - 3. Two
 - 4. Three

Q.38 निम्नलिखित में से कौन-सा विकल्प पर्यावरण और वन्य जीवन से संबंधित 7वें मौलिक कर्तव्य का उल्लंघन है?

- Ans
- 1. वन्यजीव जानवरों की तस्करी
 - 2. वन्यजीवों की बेहतरी के लिए काम करना
 - 3. संरक्षित प्रजातियों के दोहन पर रोक लगाने के लिए
 - 4. जल प्रदूषण से बचना

Q.39 Which of the following social reform organisations was established in Madras in 1864?

- Ans
- 1. The Brahmo Samaj
 - 2. The Arya Samaj
 - 3. The Prarthana Samaj
 - 4. The Veda Samaj

Q.40 When several political parties join hands to form a government and exercise political power on the basis of a common agreed programme agenda, what is it called?

- Ans
- 1. Coalition government
 - 2. Presidential government
 - 3. One party system
 - 4. Majority party government

Q.41 Community Development Programme was under the _____ Five-Year Plan in India.

- Ans
- 1. First
 - 2. Third
 - 3. Second
 - 4. Fourth

Q.42 Which of the following countries never hosted the Asian Games till 2022?

- Ans
- 1. South Korea
 - 2. Pakistan
 - 3. China
 - 4. Japan

Q.43 How many fundamental duties were added in the Indian Constitution in 1976?

- Ans
- 1. 11
 - 2. 8
 - 3. 9
 - 4. 10

Q.44 The word 'monsoon' is derived from the Arabic term 'Mausim,' which is equivalent to:

- Ans
- 1. Rain
 - 2. Season
 - 3. Storm
 - 4. Wind

Q.45 'Aamar Jiban', is the autobiography written by an Indian woman. Who was she?

- Ans
- 1. Annie Besant
 - 2. Sarojini Naidu
 - 3. Rassundari Devi
 - 4. Sucheta Kriplani

Q.46 The National Rice Research Institute is located at _____ in Odisha.

- Ans
- 1. Sambalpur
 - 2. Puri
 - 3. Koraput
 - 4. Cuttack

Q.47 Sheema Kermani is associated with which of these dance forms?

- Ans
- 1. Mohiniyattam
 - 2. Kathakali
 - 3. Bharatanatyam
 - 4. Sattriya

Q.48 Which of the following international organisations was founded in 1995?

- Ans
- 1. International Labour Organization
 - 2. World Bank
 - 3. International Monetary Fund
 - 4. World Trade Organization

Q.49 KV Prasad, SV Rajarao, Umalayapuram Sivaraman, Palghat Mani Iyer, Karaikudi R Mani and Palghat Raghu are noted players of which of the following instruments?

- Ans
- 1. Mridangam
 - 2. Sarangi
 - 3. Ghatam
 - 4. Pakhawaj

Q.50 In plants, which hormone helps the cells to grow longer?

- Ans
- 1. Ethylene
 - 2. Cytokinin
 - 3. Jasmonate
 - 4. Auxin

Section : Reasoning

Q.1 Select the set in which the numbers are related in the same way as are the numbers of the following sets.
(NOTE: Operations should be performed on the whole numbers, without breaking down the numbers into its constituent digits. E.g. 13 – Operations on 13 such as adding/subtracting/multiplying etc. to 13 can be performed. Breaking down 13 into 1 and 3 and then performing mathematical operations on 1 and 3 is not allowed.)
(84, 73, 157)
(96, 88, 184)

- Ans
- 1. (92, 75, 147)
 - 2. (89, 62, 151)
 - 3. (99, 71, 160)
 - 4. (88, 79, 191)

Q.2 Which two signs should be interchanged to make the given equation correct?

$$87 \times 2 - 80 \div 8 + 160 = 4$$

- Ans
- 1. + and ×
 - 2. + and ÷
 - 3. + and =
 - 4. + and -

Q.3 Which figure should replace the question mark (?) if the following series were to be continued?

□	☆	↑	U	O	L	U	↑	T	S											
L	O	S	T	□	☆	T	S	S	T	☆	□	O	L	□	☆	☆	□	L	O	?
↑		U	L		O	U		↑	S		U	T	↑		U					

Ans

✗ 1.

↑	O		
T	S	L	U
☆	□		

✗ 2.

↑	U		
T	L	□	S
☆	O		

✗ 3.

↑	T		
O	☆	□	L
U	S		

✓ 4.

↑	U		
T	S	O	L
☆	□		

Q.4 Select the figure that will replace the question mark (?) in the following figure series.



Ans

✗ 1.

✓ 2.

✗ 3.

✗ 4.

Q.5 Select the option figure which is embedded in the given figure (X) as its part. (rotation is NOT allowed).

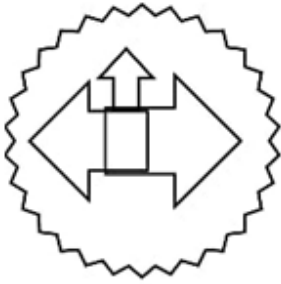

(X)

Ans

✗ 1.

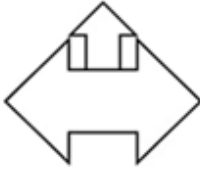

✗ 2.



✗ 3.

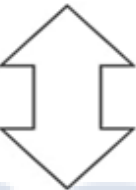

✓ 4.

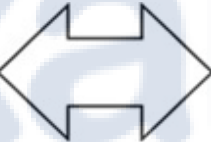

Q.6 Six students are sitting around a circular table facing the centre. Kalki is an immediate neighbour of both Oorja and Namita. Leela is sitting second to the left of Oorja. Padma is sitting second to the right of Kalki. Madhuri is sitting third to the right of Namita. Who is an immediate neighbour of both Kalki and Padma?

Ans

✓ 1. Namita

✗ 2. Oorja

✗ 3. Madhuri

✗ 4. Leela

Q.7 Select the figure from the options that can replace the question mark (?) complete the given pattern.

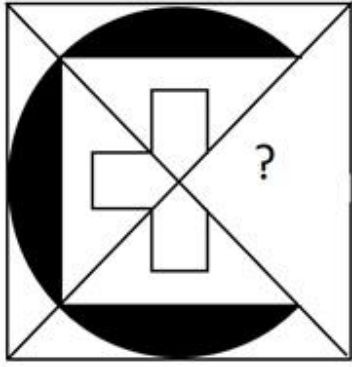

Ans

X 1.



X 2.



✓ 3.

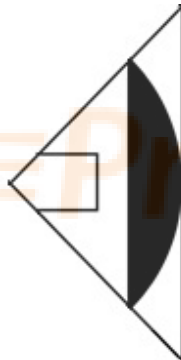

X 4.



Q.8 Six numbers, 7, 8, 9, 10, 11 and 12 are written on different faces of a dice. Three positions of this dice are shown | the number on the face opposite 7.

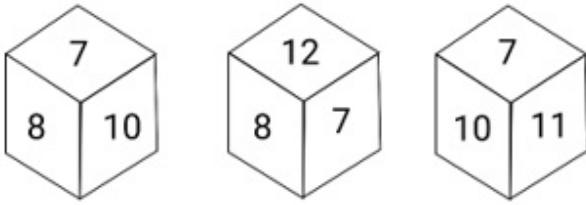

- Ans
- 1. 10
 - 2. 8
 - 3. 9
 - 4. 11

Q.9 Select the option that is embedded in the given figure (rotation is NOT allowed).

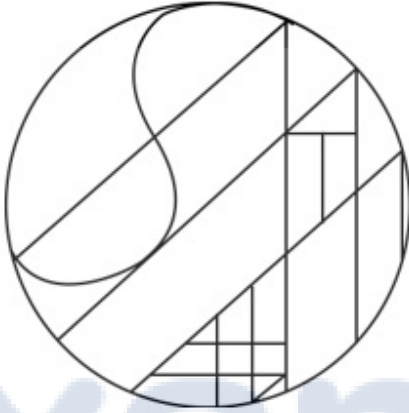

Ans

- 1.
- 2.
- 3.
- 4.

Q.10 A square transparent sheet with a pattern is shown in the given figure. Find out from amongst the following optic how the pattern would appear when the transparent sheet is folded at the dotted line.

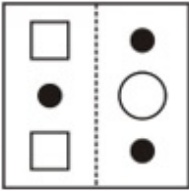

Ans

✓ 1.

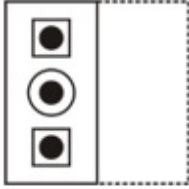

✗ 2.

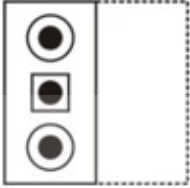

✗ 3.

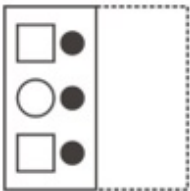

✗ 4.

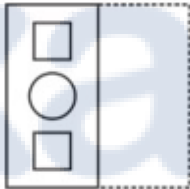

Q.11 Select the correct mirror image of the given figure when the mirror is placed at PQ as shown below.

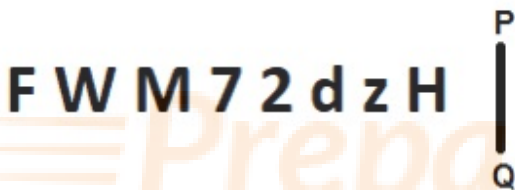

Ans

✗ 1. H z b 5 7 M W F

✓ 2. H z b 5 7 M W F

✗ 3. H z p 2 7 M W F

✗ 4. H z b 2 7 M W F

Q.12 In the equation given below, which 2 signs need to be interchanged so that it is balanced?

$$\frac{1}{2} \div \frac{1}{32} - 5 + 50 \times 80 = 50$$

Ans

✓ 1. × and -

✗ 2. ÷ and ×

✗ 3. + and -

✗ 4. + and ×

Q.13 Following question consists of 4 figures marked A, B, C and D called the Problem Figures followed by 4 other figures called the Answer Figures. Select a figure from amongst the Answer Figures which will continue the same series as established by the four Problem Figures.

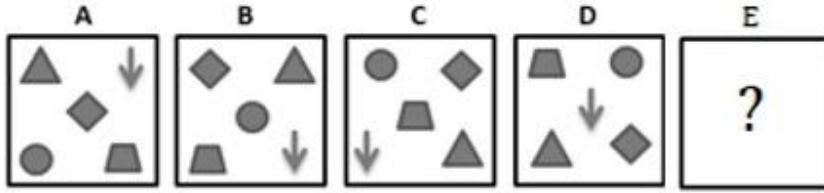

Ans

✓ 1.



✗ 2.



✗ 3.

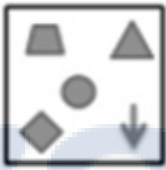

✗ 4.

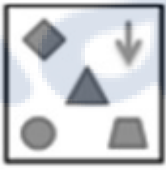

Q.14 A paper is folded and cut as shown below. How will it appear when unfolded?

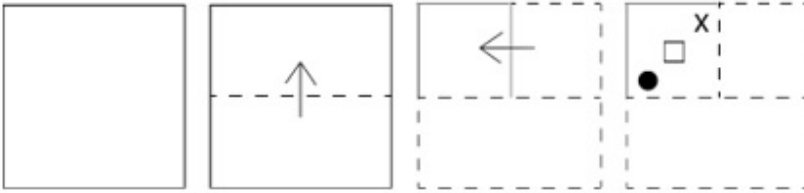

Ans

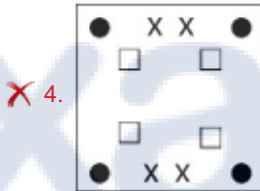
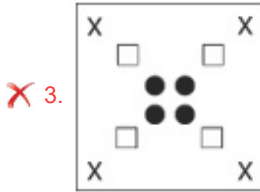
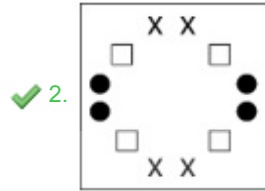
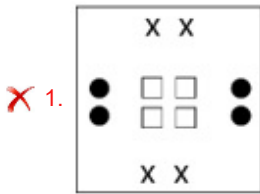

Q.15 Select the option that is related to the third term in the same way as the second term is related to the first term and the sixth term is related to the fifth term.
40 : 9 :: 100 : ? :: 50 : 11

- Ans
- ✗ 1. 20
 - ✗ 2. 42
 - ✓ 3. 21
 - ✗ 4. 51

Q.16 Select the correct mirror image of the given figure when the mirror is placed at MN as shown below.

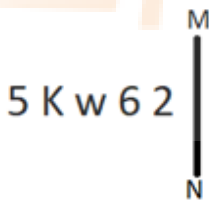

- Ans
- ✓ 1. 2 K w 5 2
 - ✗ 2. 2 9 W 6 5
 - ✗ 3. 5 w 2 5 K
 - ✗ 4. 2 9 W 6 2

Q.17 Select the option that is related to the fifth letter-cluster in the same way as the second letter-cluster is related to letter-cluster and the fourth letter-cluster is related to the third letter-cluster.
FREE : EPBA :: MORE : LMOA :: BURN : ?

- Ans
- 1. ASOK
 - 2. ASPK
 - 3. ASOJ
 - 4. AROJ

Q.18 Which of the following terms will replace the question mark (?) in the given series?
CVHT, FSJR, IPLP, ?, OJPL

- Ans
- 1. MLNM
 - 2. LMNN
 - 3. LNMN
 - 4. KMMN



Prepare 50% Faster

Q.19 Find out the figure amongst the four option in which figure X is embedded (Rotation is not allowed)

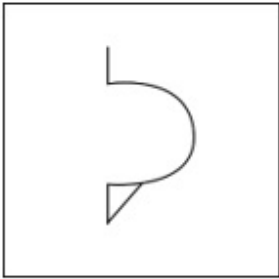

(X)

Ans

✗ 1.

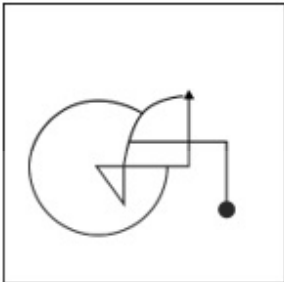

✗ 2.



✓ 3.

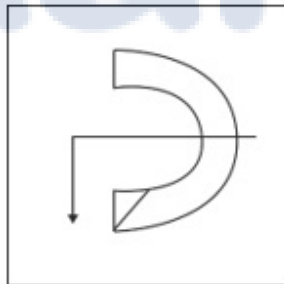

✗ 4.

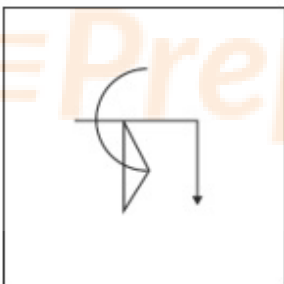

Q.20 Select the number from the given options that can replace the question mark (?) in the following series.
1, 2, 8, 48, 384, ?

Ans ✗ 1. 3456

✓ 2. 3840

✗ 3. 4608

✗ 4. 4280

Q.21 Read the given statements and conclusions carefully. Assuming that the information given in the statements is true and it appears to be at variance with commonly known facts, decide which of the given conclusions logically follow(s) from the statements.

Statements:

Some trees are rivers.

Some rivers are mountains.

Conclusions:

I. Some mountains are trees.

II. All mountains are trees.

- Ans
- 1. Only conclusion II follows
 - 2. Both conclusions I and II follow
 - 3. Only conclusion I follows
 - 4. Neither conclusion I nor II follows

Q.22 Select the figure from the options that can replace the question mark (?) and complete the given pattern.

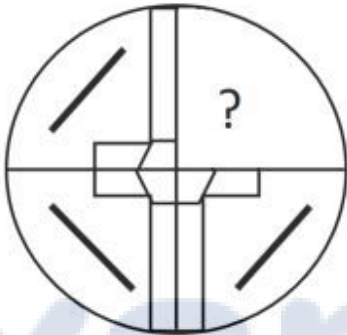

Ans

- 1.
- 2.
- 3.
- 4.

Q.23 Six letters S, T, M, P, H and Q are written on different faces of a dice. Two positions of this dice are shown in the figure. Find the letter on the face opposite to P.

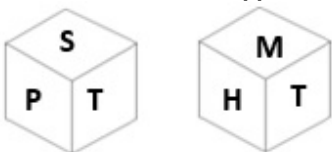

- Ans
- 1. S
 - 2. H
 - 3. T
 - 4. M

Q.24 In a certain code language, 'STAY' is written as '65' and 'COME' is written as '36'. How will 'LIST' be written in that

- Ans
- 1. 66
 - 2. 56
 - 3. 46
 - 4. 60

Q.25 How many triangles are there in the following figure?

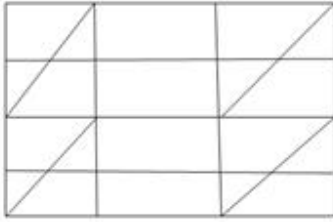

- Ans
- 1. 16
 - 2. 10
 - 3. 20
 - 4. 12

Section : Numerical Ability

Q.1 In 5 subjects of 100 marks each, a student gets an average of 62 marks and his average in the first four subjects is 5 less than the marks in the fifth subject. How many marks does he get in the fifth subject?

- Ans
- 1. 65
 - 2. 66
 - 3. 64
 - 4. 63

Q.2 The marked price of an LED is ₹9,000. The shopkeeper allows a discount of 25% and gains 8%. If no discount is allowed, his gain percentage will be:

- Ans
- 1. 46%
 - 2. 44%
 - 3. 40%
 - 4. 42%

Q.3 Akash can finish a work in 18 days, while Navin can finish the same work in 36 days. If they work together to finish the work, find the portion of the work done by Navin.

- Ans
- 1. $\frac{2}{5}$
 - 2. $\frac{1}{2}$
 - 3. $\frac{2}{3}$
 - 4. $\frac{1}{3}$

Q.4 The HCF of two numbers is 33 and their sum is 594. Find the total number of such possible pairs of numbers.

- Ans
- 1. 2
 - 2. 5
 - 3. 3
 - 4. 4

Q.5 A boat having a speed of 30 km/h in still water goes 60 km downstream and comes back in 4 hours 30 minutes. T the stream is:

- Ans
- 1. 20 km/h
 - 2. 10 km/h
 - 3. 30 km/h
 - 4. 25 km/h

Q.6 $79\frac{7}{40}$ is equivalent to:

- Ans
- 1. 79.185
 - 2. 79.0175
 - 3. 79.085
 - 4. 79.175

Q.7 एक छात्र गणना करते समय संख्या 97 को गलती से 79 पढ़ लेता है। उसकी गणना में प्रतिशत वृद्धि या कमी ज्ञात कीजिए।

- Ans
- 1. 19.55 % वृद्धि
 - 2. 19% कमी
 - 3. 18% कमी
 - 4. 18.55% कमी

Q.8 A woman invests ₹85,000 at a rate of $7\frac{1}{2}\%$ per annum simple interest for 4 years. What is the amount that she will receive after 4 years?

- Ans
- 1. ₹69,600
 - 2. ₹1,08,750
 - 3. ₹75,000
 - 4. ₹1,10,500

Q.9 If $P : (Q + R) = 2 : 5$ and $R : (P + Q) = 6 : 7$, then find the value of $Q : (P + R)$.

- Ans
- 1. 23 : 29
 - 2. 23 : 37
 - 3. 23 : 59
 - 4. 23 : 68

Q.10 The largest 3-digit prime number is:

- Ans
- 1. 983
 - 2. 991
 - 3. 987
 - 4. 997

Q.11 The population of a village increases by 3% per year. If the current population is 75,556, then find the population of the village after 3 years (neglect the decimal part).

- Ans
- 1. 82563
 - 2. 82562
 - 3. 82526
 - 4. 85262

Q.12 If both the radius and height of a right circular cone are increased by 25%, its volume will be increased by: (Approximation up to two decimal points) (Where $\pi = \frac{22}{7}$)

- Ans
- 1. 90.31%
 - 2. 79.55%
 - 3. 95.31%
 - 4. 85.33%

Q.13 The annual salary of Aprajita is 150% of Sonia's annual salary. Sonia's salary rises by 20% after an increment, whereas Aprajita's salary increases by 12%. If the initial salary of Sonia was ₹6,00,000, then what is the salary of Aprajita (in ₹) now after a hike?

- Ans
- 1. 1,08,000
 - 2. 9,00,000
 - 3. 10,08,000
 - 4. 7,20,000

Q.14 Susan sold her used mobile phone for ₹4,800 and felt that she incurred a loss of 20%. To earn a profit of 12%, at what price should it have been sold (in ₹)?

- Ans
- 1. 6,000
 - 2. 6,520
 - 3. 6,720
 - 4. 6,780

Q.15 Three metallic spheres are of the radius 6 cm, 8 cm and 10 cm, respectively. If they are melted to form a single solid sphere, then the radius of the resulting sphere is:

- Ans
- 1. 12 cm
 - 2. 24 cm
 - 3. 48 cm
 - 4. 36 cm

Section : Computer Proficiency

Q.1 You can change how MS Word 365 corrects and formats your text for spelling and grammatical errors by going to File -> Options -> _____ and _____.

- Ans
- 1. Proofing
 - 2. Page layout settings
 - 3. Font settings
 - 4. Page size settings

Q.2 Autocorrect function may be used in MS Word 365, for grammar and spell-check and it is available through:

- Ans
- 1. File→Options→Display
 - 2. File→Options→Language
 - 3. File→Options→Proofing
 - 4. File→Options→General

Q.3 In MS Excel 365, which of the following is a shortcut key to open a new spreadsheet in MS Excel?

- Ans
- 1. Alt + N
 - 2. Ctrl + O
 - 3. Alt + O
 - 4. Ctrl + N

Q.4 Which of the following functions is executed if shortcut key Ctrl + I is used in MS Word 365?

- Ans
- 1. Underline the text
 - 2. Bold the text
 - 3. Strike through the text
 - 4. Make the text italic

Q.5 In MS Excel 365, which of the following is the correct formula to calculate the average of the values in cells A1 to A10?

- Ans
- 1. =SUM(A1:A10)/10
 - 2. =SUM(A1:A10)/100
 - 3. =AVERAGE(10*A1)
 - 4. =AVERAGE(A1:A10)

Q.6 Which of the following is a type of network that allows users from outside to access the Intranet of an organisation?

- Ans
- 1. Extranet
 - 2. Double Intranet
 - 3. Externet
 - 4. Internet

Q.7 What is the primary purpose of creating a table in a word processing document?

- Ans
- 1. To organize and present information in a structured and easy-to-read format.
 - 2. To add decorative elements and enhance the visual appeal of the document.
 - 3. To apply different fonts and colours to the text within the table.
 - 4. To change the page orientation and adjust the margins of the document.

Q.8 What does 'CC' stand for in the context of email?

- Ans
- 1. Carbon Copy
 - 2. Centralised Communication
 - 3. Compose Check
 - 4. Confidential Content

Q.9 In MS Excel 365 which of the following will be used to print a spreadsheet?

- Ans
- 1. Home -> open
 - 2. File -> print
 - 3. View -> print
 - 4. Layout -> print

Q.10 Which of the following shortcut keys is used to switch to print preview in MS Word 2016?

- Ans
- 1. Page Down
 - 2. Page UP
 - 3. Ctrl+Alt+I
 - 4. Ctrl+P

Constable Executive Male and Female in Delhi Police Examination 2023

Exam Date	23/11/2023
Exam Time	9:00 AM - 10:30 AM
Subject	Constable Executive Male and Female in Delhi Police Examination 2023

Section : General Knowledge

Q.1 The colossal monolithic statue of Gomateshwara at Shravanabelagola is carved out of a single block of _____ .

- Ans**
- 1. stone
 - 2. rock
 - 3. granite
 - 4. marble

Q.2 At which of the following places was 'All India Muslim League' founded?

- Ans**
- 1. Lahore
 - 2. Karachi
 - 3. Dacca
 - 4. Calcutta

Q.3 What was the name of the official mascot for the 44th International Chess Olympiad, which was held in India in 2022?

- Ans**
- 1. Chess Base
 - 2. Bathusa Turtlestein
 - 3. Thambi
 - 4. Chess mate

Q.4 Who among the following is NOT a tabla player?

- Ans**
- 1. Zakir Hussain
 - 2. Sabir Khan
 - 3. Pannalal Ghosh
 - 4. Sandeep Das

Q.5 What is the maximum limit of loan under MUDRA Yojana?

- Ans**
- 1. ₹10 lakh
 - 2. ₹5 lakh
 - 3. ₹1 lakh
 - 4. ₹50,000

Q.6 How many general electoral rolls are there for every territorial constituency for election of the Parliament?

- Ans**
- 1. 3
 - 2. 1
 - 3. 4
 - 4. 2

Q.7 The ground water of Bihar and West Bengal is mostly contaminated by which metal?
Ans 1. Arsenic
 2. Radium
 3. Lead
 4. Mercury

Q.8 Who among the following received the title 'Nur Jahan'?
Ans 1. Meherunissa
 2. Ratan Bai
 3. Hamida Banu
 4. Man Bai

Q.9 Pandit Gopal Prasad Dubey won the Padma Shri for which form of dance?
Ans 1. Sattriya
 2. Kathakali
 3. Chhau
 4. Bihu

Q.10 A removal motion of a judge must be signed by _____ members if it is initiated in the Lok Sabha.
Ans 1. 54
 2. 50
 3. 100
 4. 75

Q.11 In which of the following states/UTs were Khelo India Youth Games 2023 organised?
Ans 1. Delhi
 2. Maharashtra
 3. Punjab
 4. Madhya Pradesh

Q.12 Which of the following elements was NOT part of the Financial Sector Reforms under the Liberalisation Model?
Ans 1. RBI's role was enhanced to gain control over banks
 2. Permission to set up private banks
 3. Setting of new branches without RBI approval
 4. Investment limit in foreign banks up to 74%

Q.13 Which of the following is NOT responsible for hypertension?
Ans 1. Excess weight and lack of exercise
 2. Intake of nicotine either through smoking or chewing tobacco
 3. Consuming less salt
 4. Living under stress and worry

Q.14 The National Social Assistance Programme (NSAP) is a welfare programme being administered by the _____.
Ans 1. Ministry of Women and Child Development
 2. Ministry of Home Affairs
 3. Ministry of Rural Development
 4. Ministry of Social Justice and Empowerment

Q.15 Which of the following organisations has declared October 2 as the International Day of Non-violence to honour Mahatma Gandhi?

- Ans
- 1. United National General Assembly
 - 2. Amnesty International
 - 3. United Nations Development Fund
 - 4. International Federation Red Cross and Red Crescent

Q.16 'Kitne Pakistan', a novel on the harsh realities of the partition is written by:

- Ans
- 1. Munshi Premchand
 - 2. Kamleshwar
 - 3. Kashi Nath Singh
 - 4. Phanishawar Nath Renu

Q.17 What is time period under Article 22 (2) of the Constitution of India for every person who is arrested and detained in custody to be produced before the nearest magistrate?

- Ans
- 1. Within 30 hours
 - 2. Within 12 hours
 - 3. Within 24 hours
 - 4. Within 48 hours

Q.18 The lowest level of administration under the Satavahana kingdom was a Grama, which was under the charge of a _____.

- Ans
- 1. Gramika
 - 2. Nagarika
 - 3. Rajuka
 - 4. Amatya

Q.19 The Tumakuru mining belt is located in which state?

- Ans
- 1. Jharkhand
 - 2. Karnataka
 - 3. Odisha
 - 4. Rajasthan

Q.20 According to Agriculture Statistics at a Glance 2015, India was the largest producer of which crop in the year 2013, contributing to about 25 per cent of the global production?

- Ans
- 1. Oilseeds
 - 2. Sugarcane
 - 3. Pulses
 - 4. Millets

Q.21 The melting point of a solid is defined as:

- Ans
- 1. the minimum temperature at which the solid melts to become liquid at a low pressure
 - 2. the maximum temperature at which the solid melts to become liquid at atmospheric pressure
 - 3. the minimum temperature at which the solid melts to become liquid at the atmospheric pressure
 - 4. the minimum temperature at which the solid melts to become liquid at a high pressure

Q.22 Who among the following is the writer of 'Train to Pakistan', 'Good, Bad and Ridiculous' and 'Delhi: A Novel'?

- Ans
- 1. Khushwant Singh
 - 2. Amitav Ghosh
 - 3. Ruskin Bond
 - 4. Vikram Seth

Q.23 Jatin Goswami, who was honoured with the Sangeet Natak Akademi Fellowship, is an exponent of _____ dar 

- Ans
- 1. Sattriya
 - 2. Kathak
 - 3. Manipuri
 - 4. Chhau

Prepare 50% Faster

Q.24 The hydrological cycle deals with _____.

- Ans
- 1. air
 - 2. rocks
 - 3. water
 - 4. soil

Q.25 The Hindustan Socialist Republican Association was founded in _____ by famous revolutionaries like Chandrasekhar Azad, Bhagat Singh, Batukeshwar Dutt and others.

- Ans
- 1. 1919
 - 2. 1921
 - 3. 1925
 - 4. 1928

Q.26 The condition, when the environment becomes enriched with nutrients, increasing the amount of plant and algae growth in estuaries and coastal waters, is called:

- Ans
- 1. greenhouse effect
 - 2. mineralisation
 - 3. eutrophication
 - 4. ozone depletion

Q.27 Which of the following is NOT the lead bank?

- Ans
- 1. State Bank of India
 - 2. HDFC Bank
 - 3. Canara Bank
 - 4. Indian bank

Q.28 Which of the following has universal acceptability in discharge of debt & payment obligations?

- Ans
- 1. Houses
 - 2. Bonds
 - 3. Legal tender money
 - 4. Landed property

Q.29 On the maternal side, Mughals were the descendants of _____.

- Ans
- 1. Genghis Khan
 - 2. Timur
 - 3. Tajuddin Yalduz
 - 4. Mohammed Ghori

Q.30 Who among the following has played the highest number of ODI matches as the Captain of the Indian cricket team, as of 2021?

- Ans
- 1. Mahendra Singh Dhoni
 - 2. Kapil Dev
 - 3. Sachin Ramesh Tendulkar
 - 4. Virat Kohli

Q.31 During which year was the first Industrial Policy Resolution passed?

- Ans
- 1. 1948
 - 2. 1958
 - 3. 1957
 - 4. 1967

Q.32 Palaeolithic Age in India has how many phases?

- Ans
- 1. One
 - 2. Three
 - 3. Two
 - 4. Four

Q.33 Which of the following cities hosted the 44th World Chess Olympiad in 2022?

- Ans
- 1. Kolkata
 - 2. Chennai
 - 3. Mumbai
 - 4. New Delhi

Q.34 The Jaffna Peninsula, known for its cultural heritage and Tamil population, is located in which part of Sri Lanka?

- Ans
- 1. Western Province
 - 2. Eastern Province
 - 3. Central Province
 - 4. Northern Province

Q.35 Kongampattu AV Murugaiyan, a _____ exponent, was awarded the Padma Shri in 2022.

- Ans
- 1. sitar
 - 2. guitar
 - 3. thavil
 - 4. dholak

Q.36 Lohri is a popular folk festival of which of these states?

- Ans
- 1. Punjab
 - 2. Himachal Pradesh
 - 3. Gujarat
 - 4. Goa

Q.37 How many fundamental rights are provided by the Constitution as of November 2022?

- Ans
- 1. 8
 - 2. 7
 - 3. 6
 - 4. 5

Q.38 Which of the following schedules vests additional discretionary powers to the Governors of Mizoram and Tripura?

- Ans
- 1. 5th Schedule
 - 2. 7th Schedule
 - 3. 4th Schedule
 - 4. 6th Schedule

Q.39 Which of the following policies involves integrating the domestic economy with the world economy?

- Ans
- 1. Privatisation
 - 2. Liberalisation
 - 3. Capitalist economy
 - 4. Globalisation

Q.40 The Brihadeshwara Temple at Thanjavur was built by which of these rulers?

- Ans
- 1. Raja Raja Chola III
 - 2. Rajadhiraja Chola II
 - 3. Rajendra Chola III
 - 4. Raja Raja Chola I

Q.41 Which of the following reports or missions mainly recommended that control over some aspects of provincial government be passed to Indian ministers responsible to an Indian electorate?

- Ans
- 1. Cripps' Mission
 - 2. Simon Commission report
 - 3. Montagu Chelmsford report
 - 4. Morley Minto report

Q.42 In which of the following years was there an all-India campaign in opposition to the all-white Simon Commission?

- Ans
- 1. 1928
 - 2. 1942
 - 3. 1922
 - 4. 1939

Q.43 According to the 2011 census, how many districts were there in India?

- Ans
- 1. 570
 - 2. 680
 - 3. 640
 - 4. 610

Q.44 Which of the following is the most common saccharide found in peach juice puree, accounting for about 55% to 80% of the total sugar content?

- Ans
- 1. Sucrose
 - 2. Galactose
 - 3. Raffinose
 - 4. Oligofructose

Q.45 Sangeet Natak Akademi is a society under which ministry of the Government of India?

- Ans
- 1. Ministry of Home Affairs
 - 2. Ministry of Tourism
 - 3. Ministry of Culture
 - 4. Ministry of Youth Affairs and Sports

Q.46 As per the Industrial Policy Resolution 1956, Schedule B comprises of _____ industries.

- Ans
- 1. 13
 - 2. 15
 - 3. 12
 - 4. 14

Q.47 To provide opportunities for education to his/her children between the ages of _____ is the fundamental duty parents according to the 86th Constitutional Amendment Act.

- Ans
- 1. 6 to 18
 - 2. 4 to 14
 - 3. 5 to 18
 - 4. 6 to 14

Q.48 Which of the following is a communication mail channel to facilitate quick delivery of mails in large towns and cities of India?

- Ans
- 1. State channel
 - 2. Small mail channel
 - 3. Bulk mail channel
 - 4. Pink channel

Q.49 Pavri Naach, a tribal dance of Maharashtra and Gujarat region is performed by which of the following tribes?

- Ans
- 1. Koli
 - 2. Kalanga
 - 3. Khatola
 - 4. Kokna

Q.50 Which Article of the Constitution of India mentions that no person accused of any offence shall be compelled to be a witness against himself/herself?

- Ans
- 1. Article 26
 - 2. Article 24
 - 3. Article 20
 - 4. Article 16

Section : Reasoning

Q.1 How many cubes are there in the given figure?

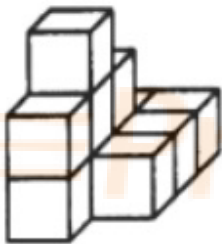

- Ans
- 1. 17
 - 2. 5
 - 3. 15
 - 4. 11

Q.2 Select the figure that will replace the question mark (?) in the following figure series.

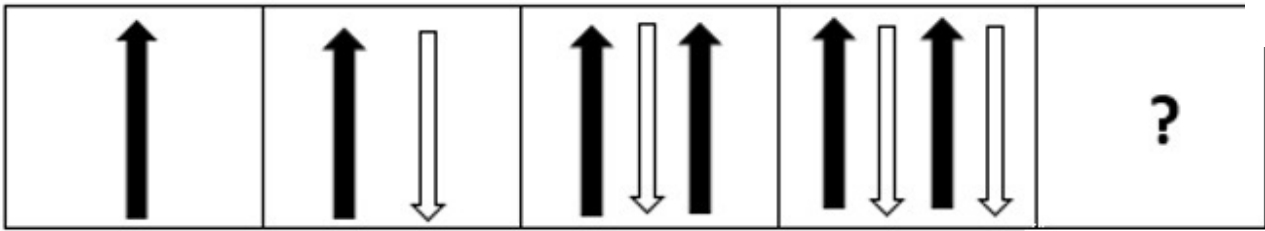

Ans

✓ 1.

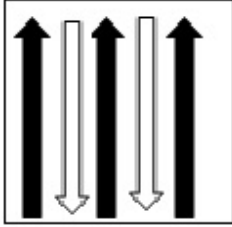

✗ 2.

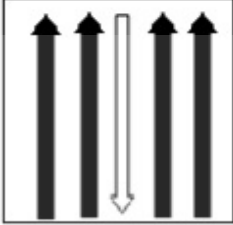

✗ 3.

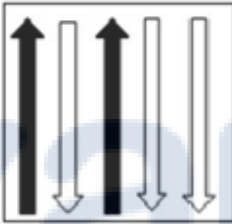

✗ 4.

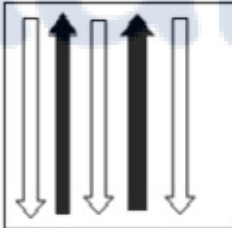

Q.3 Select the option in which the given figure is embedded (rotation is NOT allowed).

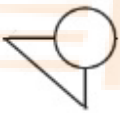

Ans

✗ 1.

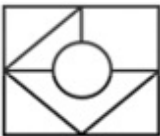

✗ 2.



✗ 3.

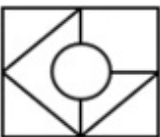

✓ 4.

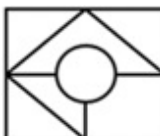

Q.4 Which figure should replace the question mark (?) if the series were to be continued?

P I C E S I	P O S E E	E I P O A I	E M A O	?
-------------	-----------	-------------	---------	---

Ans

X 1. X I E M A

X 2. X I O M A

✓ 3. O I E M X

X 4. O I E M A

Q.5

Select the option in which the given figure is embedded (rotation is NOT allowed).

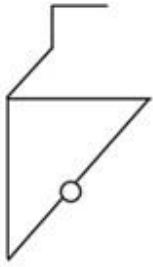

Ans

✗ 1.

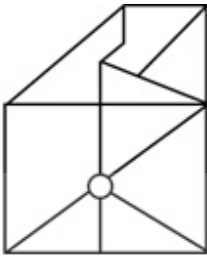

✗ 2.

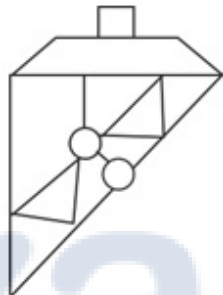

✗ 3.

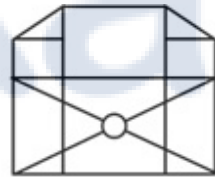

✓ 4.

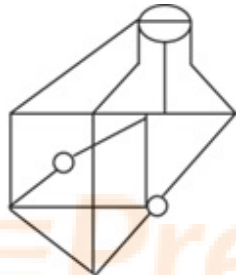

Q.6

Six letters A, B, C, D, E and F are written on different faces of a dice. Two positions of this dice are shown in the figure. Find the letter on the face opposite to 'D'.

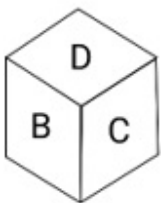

Ans

✗ 1. F

✓ 2. E

✗ 3. B

✗ 4. A

Q.7 Two statements are given followed by two conclusions numbered I and II. Assuming the statements to be true, evaluate which of the conclusions logically follow(s) from the statements:

Some balloons are bags.

All belts are bags.

Conclusions:

I. Some bags are balloons.

II. Some belts are balloons.

Ans 1. Neither conclusion I nor II follows

2. Both conclusions I and II follow

3. Only conclusion I follows

4. Only conclusion II follows

Q.8 Select the option figure that will replace the question mark (?) in the figure given below to complete the pattern.

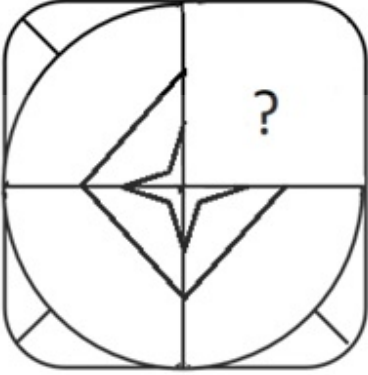

Ans

1.

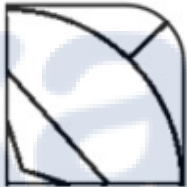

2.



3.

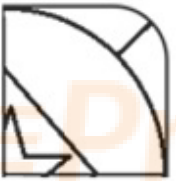

4.



Q.9 Select the set in which the numbers are related in the same way as are the numbers of the following sets.
(NOTE: Operations should be performed on the whole numbers, without breaking down the numbers into its constituent digits. E.g. 13 – Operations on 13 such as adding/subtracting/multiplying etc. to 13 can be performed. Breaking down 13 into 1 and 3 and then performing mathematical operations on 1 and 3 is not allowed)
(12, 26, 57)
(13, 27, 60)

Ans 1. (8, 91, 83)

2. (19, 25, 66)

3. (17, 21, 38)

4. (45, 64, 119)

Q.10 In a certain code language, 'NATION' is written as 'RZLRQM' and 'MARINE' is written as 'SZNRRV'. How will 'ADV' written as in that language?

- Ans
- ✓ 1. EWJRCV
 - ✗ 2. FNZPVR
 - ✗ 3. FNERCV
 - ✗ 4. ERZCWV

Q.11 Which figure should replace the question mark (?) in the following series to continue the pattern?

		X			8			B			8	
8	B	△	X	V	B	8	♡	△	B	X	♡	?
		V			△			X			△	

Ans

✓ 1.

		♡
8	C	△
		B

✗ 2.

		♡
C	8	△
		X

✗ 3.

		△
♡	B	X
		8

✗ 4.

		B
8	C	△
		♡

Q.12 Select the option that is related to the fourth number in the same way as the first number is related to the second number and the fifth number is related to the sixth number.
121 : 23 :: ? : 14 :: 166 : 32

- Ans
- ✗ 1. 71
 - ✓ 2. 76
 - ✗ 3. 80
 - ✗ 4. 81

Q.13 Select the figure from the given options that will replace the question mark (?) in the figure given below and complete the pattern.

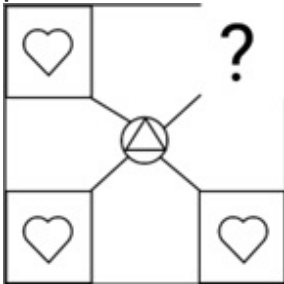

Ans

- 1.
- 2.
- 3.
- 4.

Q.14 Observe the dots on a dice (one to six dots) in the following figures. How many dots are contained on the face opposite to that containing four dots?

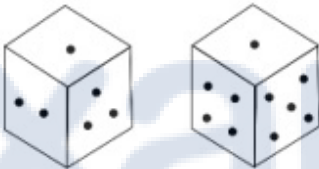

Ans

- 1. Five
- 2. One
- 3. Six
- 4. Two

Q.15 1, 2, 3, 4, 5 and 6 are written on different faces of a dice. Three different positions of the same dice are shown below. Find the number on the face opposite to the one showing '5'.

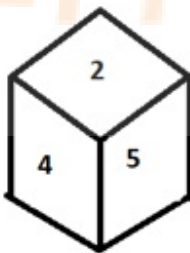

figure 1

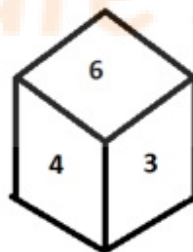

figure 2

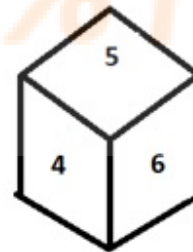

figure 3

Ans

- 1. 6
- 2. 1
- 3. 3
- 4. 2

Q.16 Which of the following option figures will complete the pattern in the figure given below?



Ans

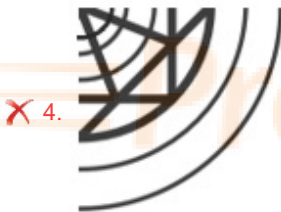

Q.17 Which two signs should be interchanged to make the given equation correct?
 $335 \times 5 \div 7 + 65 - 213 = 321$

- Ans
- ✗ 1. ÷ and -
 - ✗ 2. + and =
 - ✓ 3. ÷ and ×
 - ✗ 4. + and -

Q.18 Three different positions of the same dice are shown (Figures 1-3). Find the number on the face opposite to the face showing '2'.

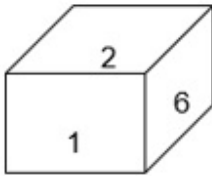

Figure 1

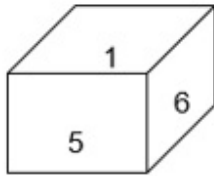

Figure 2

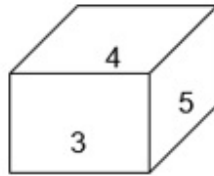
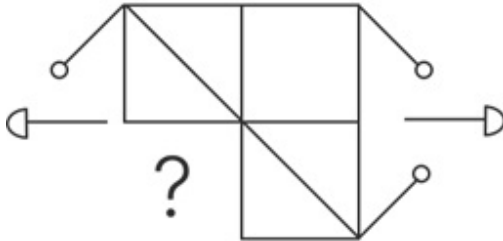

Figure 3

- Ans
- 1. 5
 - 2. 3
 - 3. 1
 - 4. 4

Q.19 Select the figure from the given options that will replace the question mark (?) in the figure given below to complete the pattern so that the final image is symmetrical.



- Ans
- 1.
 - 2.
 - 3.
 - 4.

Q.20 Select the number from among the given options that can replace the question mark (?) in the following series.

21, 22, 24, 28, 36, ?

- Ans
- 1. 67
 - 2. 47
 - 3. 52
 - 4. 43

Q.21 Select the option that represents the letters that, when sequentially placed from left to right in the blanks below, will complete the letter series.

b _ d _ p b c _ p _ _ c _ p p b _ _ p p

- Ans
- 1. cpdpdbdc
 - 2. pcdpbdc
 - 3. cpdpbdcd
 - 4. cdppbdcd

Q.22 Select the correct mirror image of the given combination when the mirror is placed at MN as shown below.



- Ans
- 1. E b 5 t 9 4 y
 - 2. y 4 9 t 5 b E
 - 3. E b 2 t 9 4 y
 - 4. y 4 9 t 2 b E

Q.23 Select the correct combination of mathematical signs that can sequentially replace the * signs and balance the given equation.

$$18 * 14 * 6 * 16 * 4 * 254$$

- Ans
- 1. +, ×, −, =, ÷
 - 2. ÷, −, ×, +, =
 - 3. ×, +, −, ÷, =
 - 4. +, ×, −, ÷, =

Q.24 Six students are sitting around a circular table facing the centre. Sahil is an immediate neighbour of both Palak and Ruchi. Tanay is sitting second to the left of Palak. Urmi is sitting third to the right of Ruchi. Qasim is an immediate neighbour of both Ruchi and Tanay. Who is an immediate neighbour of both Urmi and Qasim?

- Ans
- 1. Tanay
 - 2. Palak
 - 3. Ruchi
 - 4. Sahil

Q.25 Select the option that is related to the fifth letter cluster in the same way as the second letter cluster is related to the first letter cluster and the fourth letter cluster is related to the third letter cluster.

$$KFUB : BKLG :: PNTD : GSKI :: IVFQ : ?$$

- Ans
- 1. ZAWV
 - 2. WNZA
 - 3. ZDPA
 - 4. WKNY

Section : Numerical Ability

Q.1 Ratnesh marked the price of a pencil box at ₹80. What is the cost price (in ₹) of the pencil box if after giving a discount of 10%, Ratnesh still gains 20%?

- Ans
- 1. 70
 - 2. 58
 - 3. 60
 - 4. 72

Q.2 If a,b,c,d and e are distinct prime numbers and the sum of these five numbers is odd, then a + b + c + d is:

- Ans
- 1. an even number
 - 2. an even prime number
 - 3. an odd number
 - 4. an odd prime number

Q.3 A closed metallic cylindrical box is 1.08 m high and its base radius is 42 cm. If the sheet of metal costs ₹90 per m^2 , then the cost of the material used in the box is:
(Where $\pi = \frac{22}{7}$)

- Ans
- 1. ₹456.5
 - 2. ₹356.4
 - 3. ₹555.8
 - 4. ₹750.4

Q.4 The population of a town decreased from 3,68,000 in 2017 to 3,27,200 in 2020. What is the percentage decrease (to the nearest integer) in the population of the town?

- Ans
- 1. 10%
 - 2. 11%
 - 3. 12%
 - 4. 15%

Q.5 A person borrows ₹12,000 for 3 years at 2% per annum simple interest. He immediately lends it to another person at 4% per annum for 3 years. Find his gain in the transaction per year.

- Ans
- 1. ₹360
 - 2. ₹630
 - 3. ₹240
 - 4. ₹720

Q.6 What is the greatest possible length which can be used to measure exactly the length 5 metre 95 centimetre, 8 metre and 16 metre 65 centimetre?

- Ans
- 1. 5 centimetre
 - 2. 50 metre
 - 3. 50 centimetre
 - 4. 5 metre

Q.7 If $P : Q = 5 : 3$, then find the value of $(P^4 - Q^4) : (P^4 + Q^4)$.

- Ans
- 1. 272 : 353
 - 2. 227 : 335
 - 3. - 272 : 353
 - 4. - 227 : 353

Q.8 If Ram walks at a speed of 8 km/h, he misses a train by 7 minutes. However, if he walks at a speed of 10 km/h, he reaches the station 5 minutes before the departure of the train. Find the distance (in km) between Ram's house and the station.

- Ans
- 1. 9
 - 2. 6
 - 3. 8
 - 4. 7

Q.9 Arun receives a monthly salary. The ratio of his expenditure to savings is 8 : 2. What percentage of his salary does he spend?

- Ans
- 1. 40%
 - 2. 20%
 - 3. 60%
 - 4. 80%

Q.10 A person sells two articles for ₹5,000 each with no loss and no profit in the overall transaction. If one is sold at a $16\frac{2}{3}\%$ loss, then the other is sold at a profit of:

- Ans
- 1. 24%
 - 2. 15%
 - 3. 20%
 - 4. 25%

Q.11 A cricketer has an average score of 52 runs in 10 innings. Find the number of runs to be scored by him in the 11th inning to raise the average score to 58.

- Ans
- 1. 98
 - 2. 118
 - 3. 107
 - 4. 122

Q.12 A man can complete a work in 15 days, and a woman can complete the same work in 25 days. In how many days will 3 men and 5 women complete the same work?

- Ans
- 1. 2.5
 - 2. 2
 - 3. 3.5
 - 4. 5

Q.13 Which of the following pairs of numbers are relatively prime to each other?

- Ans
- 1. (103, 113)
 - 2. (51, 119)
 - 3. (27, 51)
 - 4. (98, 567)

Q.14 A cone shape tent is made with canvas. The radius of the tent is 7 units and total 308 square units of canvas is used to make it. What is the volume of the tent in cubic units?

(Take $\pi = \frac{22}{7}$)

- Ans
- 1. $\frac{1087}{\sqrt{3}}$
 - 2. $\frac{1078}{\sqrt{3}}$
 - 3. $1087\sqrt{3}$
 - 4. $1078\sqrt{3}$

Q.15 A music player is sold for ₹4,510 cash, or ₹1,200 cash down payment and the balance in three equal easy installments. If 10% is the rate of interest compounded annually, find the amount of instalment.

- Ans
- 1. ₹1,330
 - 2. ₹1,332
 - 3. ₹1,331
 - 4. ₹1,333

Q.1 Which of the following can be done by using the Spelling and Grammar tool in MS Word 365?

- A. Indicate grammatical errors
- B. Correct spelling errors as you type
- C. Identify words with capitalisation problems

- Ans
- 1. A and B only
 - 2. A and C only
 - 3. B and C only
 - 4. A, B and C

Q.2 In MS Excel 365, Which of the following is the correct way to save a duplicate MS Excel workbook with the same name as the original workbook, but in a different folder?

- Ans
- 1. Press 'Ctrl + D'
 - 2. Press Ctrl +V
 - 3. Click on the 'Insert' menu and select 'Save'.
 - 4. Select the desired folder in the 'Save in' field of the 'Save As' dialog box and click on the 'Save' button.

Q.3 Which option is used to save changes made to an existing document in Microsoft Word 365?

- Ans
- 1. Save
 - 2. Save With
 - 3. Save Changes
 - 4. Save All

Q.4 Which of the following components is typically included in the header of an email?

- Ans
- 1. Salutation
 - 2. Body text
 - 3. Subject line
 - 4. Signature

Q.5 In MS Word 365, which of the following commands allows the user to preview the document before printing it on paper?

- Ans
- 1. View
 - 2. Print
 - 3. Layout Print Layout
 - 4. Print Preview

Q.6 In MS Excel 365, which of the following functions is used to find the smallest value in a range of cells?

- Ans
- 1. MIN
 - 2. AVERAGE
 - 3. COUNT
 - 4. SUM

Q.7 Which of the following is NOT a type of network?

- Ans
- 1. ROR
 - 2. MAN
 - 3. LAN
 - 4. WAN

Q.8 In MS Excel 365 which of the following keyboard shortcuts is used for saving a workbook in MS Excel 365?

- Ans
- 1. Shift + C
 - 2. Ctrl + V
 - 3. Ctrl + S
 - 4. Shift + S

Q.9 Which of the following terms is used to describe the space between the edge of the paper and the text in MS word

- Ans
- 1. Size
 - 2. Columns
 - 3. Margins
 - 4. Orientation

Q.10 Which of the following is the shortcut key to Cut text in MS Word 365?

- Ans
- 1. Shift+X
 - 2. Ctrl+X
 - 3. Ctrl+C
 - 4. Ctrl+Shift+X



Prepare 50% Faster

Constable Executive Male and Female in Delhi Police Examination 2023

Exam Date	23/11/2023
Exam Time	12:00 PM - 1:30 PM
Subject	Constable Executive Male and Female in Delhi Police Examination 2023

Section : General Knowledge

Q.1 Which scheme was rolled out to effectively integrate India's manufacturing capabilities with the demands of global supply chains and to promote domestic value addition and exports?

- Ans**
- 1. Merchandise Exports from India Scheme
 - 2. Make in India initiative
 - 3. Startup India
 - 4. Production Linked Incentive Scheme

Q.2 The final event in decathlon is always:

- Ans**
- 1. 110 m hurdle
 - 2. 1500 m race
 - 3. 800 m race
 - 4. javelin throw

Q.3 Which of the following is NOT a national festival?

- Ans**
- 1. Independence Day
 - 2. Republic Day
 - 3. Diwali
 - 4. Gandhi Jayanti

Q.4 Stainless steel cookware contains _____.

- Ans**
- 1. magnesium
 - 2. chromium
 - 3. manganese
 - 4. calcium

Q.5 Ayushman Bharat Programme is an umbrella of _____ scheme launched in 2018.

- Ans**
- 1. livelihood
 - 2. health
 - 3. employment
 - 4. education

Q.6 As per Köppen climate classification, the climate of which place is classified as 'Cwg' (meso thermal with dry winters)?

- Ans**
- 1. Gangetic plains
 - 2. North-western Gujarat
 - 3. Extreme western Rajasthan
 - 4. South of Goa

Q.7 Who among the following is credited for laying the foundation of microfinance institutions?

- Ans
- 1. PV Narasimha Rao
 - 2. Amartya Sen
 - 3. Jagdish Bhagwati
 - 4. Muhammad Yunus

Q.8 Which king of the Mauryan dynasty succeeded Chandragupta Maurya?

- Ans
- 1. Brihadratha
 - 2. Bindusara
 - 3. Samprati
 - 4. Ashoka

Q.9 In order to preserve pickles, a mixture of 5% to 8% of acetic acid in water is used. This preservative is also commonly known as:

- Ans
- 1. salt
 - 2. oil
 - 3. lemon juice
 - 4. vinegar

Q.10 Who became India's first weightlifter to win a gold medal at the IWF Junior World Championships, in 2022?

- Ans
- 1. Harshada Sharad Garud
 - 2. T Madhavan
 - 3. Anjali Patel
 - 4. Muna Nayak

Q.11 Which of the following Acts was passed by Governor General Lord William Bentinck in 1829?

- Ans
- 1. Bengal Sati Regulation Act
 - 2. Indian Slavery Act
 - 3. Criminal Tribes Act
 - 4. Indian Telegraph Act

Q.12 निम्नलिखित में से किस नृत्य का अर्थ 'मोहिनी का नृत्य' है?

- Ans
- 1. कुचिपुड़ी
 - 2. सत्रीया
 - 3. कथक
 - 4. मोहिनीअट्टम

Q.13 Purushottam Dadheech is a famous and recognised Indian _____ dancer.

- Ans
- 1. Kathak
 - 2. Kuchipudi
 - 3. Kathakali
 - 4. Sattriya

Q.14 Under which Constitutional Amendment Act were the Fundamental Duties first added to the Indian Constitution?

- Ans
- 1. 42nd Constitutional Amendment Act
 - 2. 43rd Constitutional Amendment Act
 - 3. 41st Constitutional Amendment Act
 - 4. 40th Constitutional Amendment Act

Q.15 Who among the following won the '67th Filmfare Award 2022 for Best Choreography' for the film Atrangi Re?
Ans 1. Remo D' Souza
 2. Vijay Ganguly
 3. Prabhu Deva
 4. Farah Khan

Q.16 Ustad Amjad Ali Khan is the maestro in playing the _____.
Ans 1. sitar
 2. tabla
 3. bansuri
 4. sarod

Q.17 Identify the first Gurjara Partihara ruler who successfully defeated the Arab invaders.
Ans 1. Mahendrapala I
 2. Vatsaraja
 3. Mahipala
 4. Nagabhata I

Q.18 The Constitution (42nd Amendment) Act, 1976, Chapter IV-A introduced a code of ten _____ for citizens.
Ans 1. Fundamental Duties
 2. Fundamental Rights
 3. Directive Principles
 4. Fundamental Principles

Q.19 'Faster, More Inclusive and Sustainable Growth' was the centre point of which Five-Year Plan?
Ans 1. Ninth
 2. Twelfth
 3. Tenth
 4. Seventh

Q.20 Which of the following Articles of the Indian Constitution deals with the District Planning Committee?
Ans 1. 243- WD
 2. 243-YD
 3. 243-XD
 4. 243-ZD

Q.21 'Vrittayata' is a major sub-division of _____ style of temple architecture.
Ans 1. Vijayanagara
 2. Dravidian
 3. Nagara
 4. Hoysala

Q.22 The term 'checkmate' is used in _____.
Ans 1. Golf
 2. Badminton
 3. Chess
 4. Tennis

Q.23 _____ delegates from all over the country congregated for the first session of the Indian National Congress at December 1885.

- Ans
- 1. 72
 - 2. 51
 - 3. 105
 - 4. 179

Q.24 Who among the following defeated Mughal emperor Humayun in the Battle of Kannauj in 1540?

- Ans
- 1. Islam Shah
 - 2. Sher Shah Suri
 - 3. Bahadur Shah
 - 4. Tatar Khan

Q.25 Which of the following statements is correct with regard to the effect of globalisation on India and other developing countries?

- Ans
- 1. Flow of information became highly restricted.
 - 2. Flow of international capital got restricted.
 - 3. It led to increased inequality between countries.
 - 4. It reduced interdependence between countries.

Q.26 Which State has the maximum number of members in Rajya Sabha?

- Ans
- 1. Uttar Pradesh
 - 2. Bihar
 - 3. Punjab
 - 4. Haryana

Q.27 When is National Unity Day observed?

- Ans
- 1. 8 November
 - 2. 31 November
 - 3. 31 October
 - 4. 11 March

Q.28 Who inaugurated the 44th Chess Olympiad, which was organised in 2022?

- Ans
- 1. Anurag Thakur
 - 2. Narendra Modi
 - 3. Viswanathan Anand
 - 4. MK Stalin

Q.29 The Teliya Dam is located in which state of India?

- Ans
- 1. Andhra Pradesh
 - 2. Karnataka
 - 3. Jharkhand
 - 4. Rajasthan

Q.30 What is the name of the autobiography written by the 14th Dalai Lama?

- Ans
- 1. My Country My Life
 - 2. Freedom in Exile
 - 3. Long Walk to Freedom
 - 4. Living with the Himalayan Masters

Q.31 Which of the following is the first published novel of the famous author Salman Rushdie?

- Ans
- 1. Shame
 - 2. The Satanic Verses
 - 3. The Moor's Last Sigh
 - 4. Grimus

Q.32 According to the Planning Commission of India (2011-12), which state has the highest percentage of the population below the poverty line?

- Ans
- 1. Chhattisgarh
 - 2. Madhya Pradesh
 - 3. Assam
 - 4. Bihar

Q.33 From which country did India import wheat seeds during the Green Revolution?

- Ans
- 1. USA
 - 2. Britain
 - 3. Russia
 - 4. Mexico

Q.34 Minister of state can attend the cabinet meeting _____.

- Ans
- 1. only when the speaker invites him
 - 2. because its compulsory for him
 - 3. only when invited
 - 4. on his own will

Q.35 The famous Chinese Buddhist pilgrim, Fa Hein visited India during the reign of which of the following Gupta rulers?

- Ans
- 1. Samudragupta
 - 2. Kumargupta
 - 3. Chandragupta II
 - 4. Sri Gupta

Q.36 What does LPG cooking gas contain?

- Ans
- 1. Propane and butane
 - 2. Methane and ethylene
 - 3. Propane and ethane
 - 4. Methane and propane

Q.37 In which of the following places were the remains of Mahaparinirvana Buddha found? It is at this location that a 6.1 m long reclining Buddha has been constructed.

- Ans
- 1. Vethipada
 - 2. Bodhgaya
 - 3. Kushinagar
 - 4. Vaishali

Q.38 Which directive principle provides for a uniform civil code for citizens?

- Ans
- 1. Article 41
 - 2. Article 42
 - 3. Article 43
 - 4. Article 44

Q.39 During the census 2011, which of the following states recorded the lowest growth rate?

- Ans**
- 1. Nagaland
 - 2. Madhya Pradesh
 - 3. Sikkim
 - 4. Uttar Pradesh

Q.40 Guru Amubi Singh won the Sangeet Natak Akademi Award for which form of dance?

- Ans**
- 1. Manipuri
 - 2. Kathakali
 - 3. Bihu
 - 4. Odissi

Q.41 In which state is the Kanha National Park located?

- Ans**
- 1. Himachal Pradesh
 - 2. Bihar
 - 3. Karnataka
 - 4. Madhya Pradesh

Q.42 In which of the following Articles of the Constitution of India, is it mentioned that “it shall be the duty of every citizen of India to value and preserve the rich heritage of our composite culture”?

- Ans**
- 1. 51A (h)
 - 2. 51A (m)
 - 3. 51A (f)
 - 4. 51A (b)

Q.43 In which of the following cities of British India was the Communist Party of India founded, in 1925?

- Ans**
- 1. Delhi
 - 2. Calcutta
 - 3. Kanpur
 - 4. Lucknow

Q.44 Which neighbouring country of India was the eighth most populous country in the world, as per the US Census Bureau, by July 2022?

- Ans**
- 1. Bangladesh
 - 2. Nepal
 - 3. Bhutan
 - 4. Myanmar

Q.45 Which of the following is NOT a type of budget of the Government?

- Ans**
- 1. Circle budget
 - 2. Balanced budget
 - 3. Surplus budget
 - 4. Deficit budget

Q.46 Who among the following dancers and choreographers is credited to bring fusion art into a dance where European style is mixed with Indian Classical Dance?

- Ans**
- 1. Birju Maharaj
 - 2. Uday Shankar
 - 3. Rukmini Devi Arundale
 - 4. Kelucharan Mohapatra

Q.47 Who coined the name 'Pakistan'?

- Ans
- 1. Md Iqbal
 - 2. Chaudhry Rehmat Ali
 - 3. Md Ali Jinnah
 - 4. Aga Khan

Q.48 Identify the Headquarters of the East Coast Railway Zone of India?

- Ans
- 1. Kolkata
 - 2. Mumbai
 - 3. Bhubaneswar
 - 4. New Delhi

Q.49 According to the Köppen classification, which group of climate is generally found at higher latitudes or higher altitudes?

- Ans
- 1. A group
 - 2. E group
 - 3. C group
 - 4. D group

Q.50 Which of the following statements about plastids is INCORRECT?

- Ans
- 1. Leucoplasts are white or colourless plastids.
 - 2. Plastids do not have their own DNA and ribosomes.
 - 3. Leucoplasts are primarily organelles in which materials such as starch, oils and protein granules are stored.
 - 4. Chromoplasts are responsible for photosynthesis in plants.

Section : Reasoning

Q.1 How many triangles are there in the given figure?

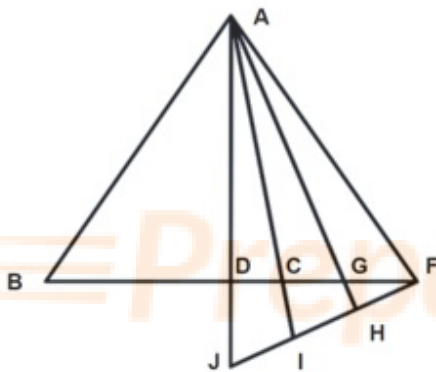

- Ans
- 1. 22
 - 2. 17
 - 3. 19
 - 4. 15

Q.2 Which of the following option figures will complete the pattern in the figure given below?



Ans

- 1.
- 2.
- 3.
- 4.

Q.3 Select the number from among the given options that can replace the question mark (?) in the following series.

10, 15, 30, 75, 210, ?

- Ans
- 1. 600
 - 2. 615
 - 3. 567
 - 4. 435

Prepare 50% Faster

Q.4 Select the option figure that is embedded in the given figure. (Rotation is not allowed)

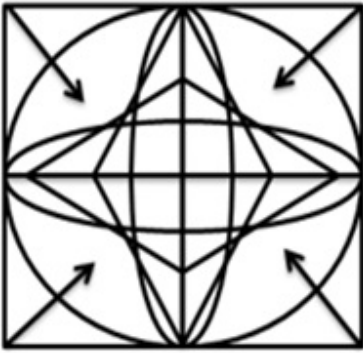

Ans

X 1.



✓ 2.

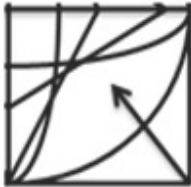

X 3.

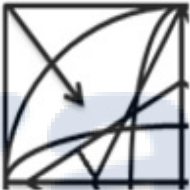

X 4.



Q.5 Select the option in which the given figure is embedded (rotation is NOT allowed).

Ans

X 1.

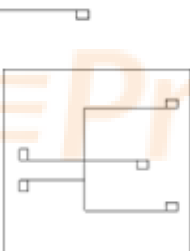

X 2.

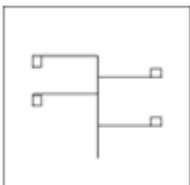

✓ 3.

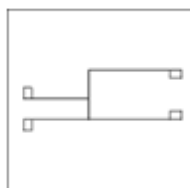

X 4.

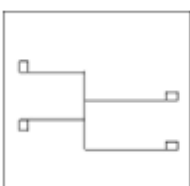

- Q.6 In a certain code language, if NOVEL is coded as 67 and HISTORY is coded as 75, then how will SCIENCE be coded?
- Ans
- ✗ 1. 120
 - ✗ 2. 126
 - ✓ 3. 131
 - ✗ 4. 130

Q.7 Which figure should replace the question mark (?) if the series were to be continued?

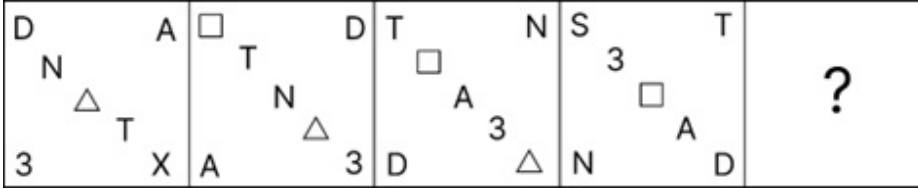

Ans

- ✗ 1.

N	A	S
A	3	□
D	□	T
- ✗ 2.

3	S	N
□	T	D
□	D	A
- ✓ 3.

3	S	□
T	N	D
T	D	A
- ✗ 4.

3	□	N
□	A	D
T	D	S

Q.8 Select the correct mirror image of the given figure when the mirror is placed at PQ as shown below.

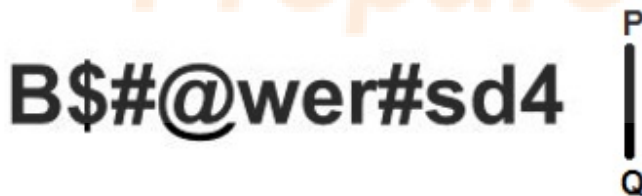

Ans

- ✗ 1. B\$#@wer#sd4
- ✗ 2. B\$#@wer#sd4
- ✓ 3. B\$#@wer#sd4
- ✗ 4. B\$#@wer#sd4

Q.9 A square sheet of paper is folded along the dotted line successively along the directions shown and is then punched last. How would the paper look when unfolded?

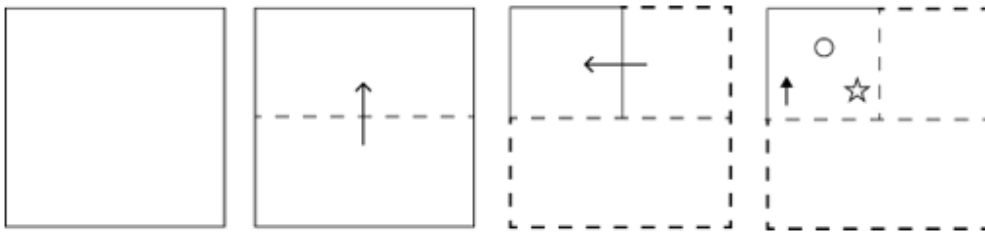

Ans

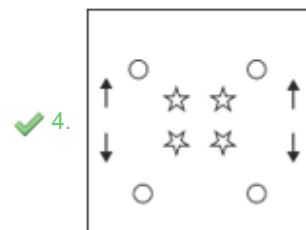
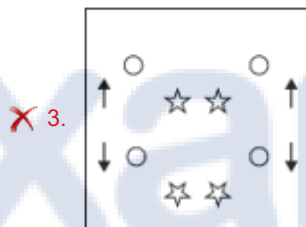
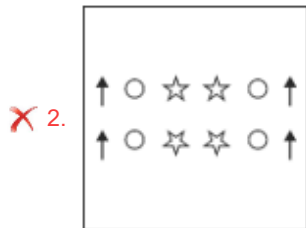
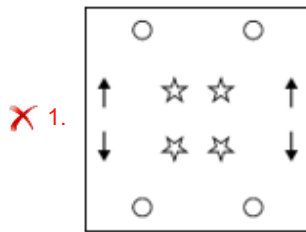

Q.10 Two statements are given, followed by three conclusions numbered I, II and III. Assuming the statements to be true, even if they seem to be at variance with commonly known facts, decide which of the conclusions logically follow(s) from the statements.

Statements:

All chips are snacks.

Some fried foods are chips.

Conclusions:

I. All fried foods are snacks.

II. Some snacks are fried foods.

III. No fried food is snack.

- Ans
- ✓ 1. Only conclusion II follows
 - ✗ 2. Either conclusion I or III follows
 - ✗ 3. Only conclusion III follows
 - ✗ 4. Only conclusions II and III follow

Q.11 Select the option that is related to the fifth letter-cluster in the same way as the second letter-cluster is related to the first letter-cluster and the fourth letter-cluster is related to the third letter-cluster.

GAIN : PKCI :: KEYS : UAGM :: ACHE : _____

- Ans
- ✗ 1. ECHA
 - ✗ 2. EJCE
 - ✓ 3. GJEC
 - ✗ 4. BDIF

Q.12 Six numbers 1, 2, 3, 4, 5 and 6 are written on different faces of a dice. Two positions of this dice are shown in the number on the face opposite to 2.

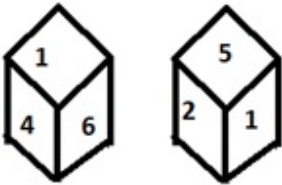

- Ans
- 1. 3
 - 2. 4
 - 3. 5
 - 4. 6

Q.13 Select the set in which the numbers are related in the same way as are the numbers of the following sets. (NOTE : Operations should be performed on the whole numbers, without breaking down the numbers into its constituent digits. E.g. 13 – Operations on 13 such as adding /deleting /multiplying etc. to 13 can be performed. Breaking down 13 into 1 and 3 and then performing mathematical operations on 1 and 3 is NOT allowed) (50, 63), (101, 120)

- Ans
- 1. (169, 196)
 - 2. (226, 253)
 - 3. (145, 168)
 - 4. (402, 440)

Q.14 Five people A, B, C, D and E are sitting in a straight row, facing north. Only two people are seated to the left of C. D is sitting at the extreme right end. B is not an immediate neighbour of D, and is second to the left of A. Where is B sitting?

- Ans
- 1. To the immediate right of E
 - 2. Fourth to the left of D
 - 3. To the immediate right of C
 - 4. Third to the left of A

Q.15 Select the option that is related to the third term in the same way as the second term is related to the first term and the sixth term is related to the fifth term. 9 : 729 :: 11 : ? :: 4 : 64

- Ans
- 1. 99
 - 2. 1342
 - 3. 1331
 - 4. 121

Q.16 Select the correct combination of mathematical signs to sequentially replace the * signs and to balance the given equation. $225 * 15 * 10 * 50 * 25 * 125$

- Ans
- 1. $\div, \times, -, +, =$
 - 2. $+, \times, -, \div, =$
 - 3. $\div, \times, +, -, =$
 - 4. $\div, +, -, \times, =$

Q.17 Six numbers, 21, 22, 23, 24, 25 and 26 are written on different faces of a dice. Three positions of this dice are shown here. Find the number on the face opposite 25.

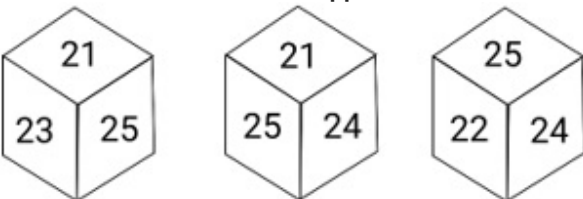

- Ans
- 1. 24
 - 2. 21
 - 3. 26
 - 4. 22

Q.18 Which of the following option figures will complete the pattern in the figure given below?



Ans



Q.19 Select the figure that will replace the question mark (?) in the following figure series.



Ans



Q.20 Select the correct combination of mathematical signs that can sequentially replace the * signs and balance the given expression.

$$73 * 12 * 5 * 2 * 39 * 64$$

Ans ✓ 1. +, ×, ÷, -, =

✗ 2. ÷, +, ×, -, =

✗ 3. +, -, ×, ÷, =

✗ 4. ×, +, -, ÷, =

Q.21 Which figure should replace the question mark (?) if the following series were to be continued?

☆	=	B	△	☆	F	=	△	☆	B						
O	F	△	☆	=	Z	O	B	△	☆	F	Z	O	=	△	
B		Z	O	F	=	Z	O	B	F	Z					?

Ans

✗ 1.

O	Z
F	☆
=	△

✗ 2.

F	Z
☆	=
O	△

✓ 3.

F	△
☆	B
O	=

✗ 4.

F	=
☆	Z
O	△

Q.22 Select the option that represents the letters that, when sequentially placed from left to right in the blanks below, will complete the letter series.

S _ _ A D _ Q W _ D _ Q W A _ S Q _ _ D

Ans ✓ 1. QWSASDWA

✗ 2. QWSASAWD

✗ 3. QWSAADWA

✗ 4. QWSASDQA

Q.23 Six letters, G, H, I, J, K and L are written on different faces of a dice. Three positions of this dice are shown here. Find the letter on the face opposite L.



Ans ✗ 1. H

✗ 2. J

✓ 3. I

✗ 4. G

Q.24 Select the option figure that will replace the question mark (?) in the figure given below. Complete the pattern.



Ans

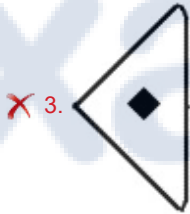
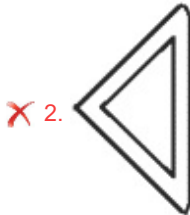
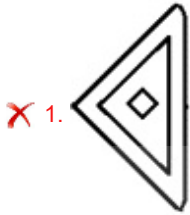

Q.25 Select the correct mirror image of the given combination when the mirror is placed at MN as shown below.

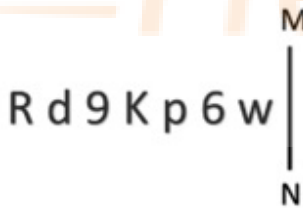

Ans ✓ 1. w ə q k e b я

✗ 2. я b e k q ə W

✗ 3. я q ə k e b w

✗ 4. w ə q k e b я

Q.1 If the radius of a sphere is increased by 3 cm, then its surface area increases by $156 \pi \text{ cm}^2$. The radius of the sphere before the increase was:

- Ans
- 1. 5 cm
 - 2. 8 cm
 - 3. 6 cm
 - 4. 7 cm

Q.2 Two erasers cost ₹2 each and are free with one packet of pencils costing ₹15. The discount will be:

- Ans
- 1. $21 \frac{1}{19}\%$
 - 2. $26 \frac{2}{3}\%$
 - 3. $78 \frac{18}{19}\%$
 - 4. $13 \frac{1}{3}\%$

Q.3 A bag contains 4800 g of rice. 20% of rice is added in the bag after which 10% quantity is taken out. Then 15% quantity is added back in the bag. Lastly, 25% of rice is taken out of the bag. What is the weight of the bag now, in grams?

- Ans
- 1. 4471.2
 - 2. 7452
 - 3. 4173.12
 - 4. 4473.2

Q.4 Gopi purchased an article at $\frac{7}{8}$ of its selling price. Had he sold it at 20% more than the selling price, then what would his profit percentage be?

- Ans
- 1. $37 \frac{1}{7}\%$
 - 2. 37%
 - 3. 35%
 - 4. $35 \frac{1}{7}\%$

Q.5 If $a : b = 3 : 4$, then the $(5a + 7b) : (7a + 5b)$ is:

- Ans
- 1. 31 : 41
 - 2. 31 : 32
 - 3. 43 : 41
 - 4. 43 : 31

Q.6 What is the area (in cm^2) of a parallelogram whose base length and height are 4 cm and 5 cm, respectively?

- Ans
- 1. 20
 - 2. 15
 - 3. 18
 - 4. 10

Q.7 If $0.2x = 0.04y$, then the value of $\frac{x+y}{y-x}$ is:

- Ans
- 1. $\frac{1}{3}$
 - 2. $\frac{3}{2}$
 - 3. $\frac{1}{2}$
 - 4. $\frac{2}{3}$

Q.8 Sushil's income is 22% less than Abhishek's income. Abhishek's income is what % more than Sushil's income?

- Ans
- 1. 25.8%
 - 2. 30.8%
 - 3. 27.8%
 - 4. 28.20%

Q.9 Which of the following numbers is prime?

- Ans
- 1. 144757
 - 2. 144393
 - 3. 144765
 - 4. 144723

Q.10 Mr. Sharma deposits his retirement benefit of ₹5 lakhs, partly in a post office and partly in a bank, at 12% and 10% p.a. rate of interest, respectively. If his monthly interest income was ₹4,500, then the difference between the deposit in the post office and in the bank is:

- Ans
- 1. ₹1,50,000
 - 2. ₹1,60,000
 - 3. ₹1,40,000
 - 4. ₹1,00,000

Q.11 A goods train travelling at a constant speed crosses two persons walking in the same direction (as that of the train) in 10.6 seconds and 11 seconds, respectively. The first person was walking at 5.4 km/h, while the second was walking at 6.3 km/h. What was the length of the train (in m)?

- Ans
- 1. 72.975
 - 2. 72.875
 - 3. 72.675
 - 4. 72.725

Q.12 Rajan covered a total distance of 108 km at an average speed of 12 km/h. He covers $\frac{1}{6}$ of total distance in 2 hours while $\frac{1}{4}$ of the total distance at a speed of 9 km/h. In how much time did he cover the remaining distance?

- Ans
- 1. 4 hours
 - 2. 3 hours
 - 3. 5 hours
 - 4. 2 hours

Q.13 Find the difference between the compound interests on ₹2,000 for 1 year at 8% p.a. compounded annually and half annually.

Ans 1. ₹2.00
 2. ₹3.20
 3. ₹2.20
 4. ₹3.00

Q.14 If A can do a piece of work in 16 days and B can do the same work in 24 days, the least whole number of days to complete the work, if they start working on alternate days, is:

Ans 1. 20
 2. 21
 3. 18
 4. 19

Q.15 The sum of two numbers is 1904 and their HCF 56. The number of such number pairs is:

Ans 1. 4
 2. 9
 3. 8
 4. 3

Section : Computer Proficiency

Q.1 What does URL stand for?

Ans 1. United Resources Locator
 2. Uniform Resource Location
 3. Uniform Receivers Locator
 4. Uniform Resource Locator

Q.2 Which of the following is true about sort A to Z in MS-Excel 365?

Ans 1. Sorts the selected column in an ascending order
 2. Sorts the selected column in an descending order
 3. Sorts data in multiple column by applying different sort criteria
 4. Sorts the selected row in an descending order

Q.3 Which of the following is an area where the outgoing messages or messages that are in the process of sending or which failed to send are stored?

Ans 1. Sentmail
 2. Inbox
 3. Outbox
 4. Trash

Q.4 Which option in Microsoft Excel allows you to create a custom bullet style for a bulleted list?

Ans 1. Define New Bullet
 2. Text Box
 3. Styles
 4. Format Cells

Q.5 What is the purpose of the 'Track Changes' feature in Microsoft Word 365?

Ans 1. To highlight spelling and grammar errors in a document.
 2. To create a backup copy of the document.
 3. To automatically save changes made to a document.
 4. To keep a record of edits made to a document by different authors.

Q.6 Which of the following keyboard shortcuts can be used to paste cut text after moving it?

- Ans
- 1. Ctrl + V
 - 2. Ctrl + X
 - 3. Ctrl + P
 - 4. Ctrl + C

Q.7 Which of the following signs appears when you drag the fill handle while creating text, number and data series in MS Excel 365?

- Ans
- 1. \$
 - 2. *
 - 3. =
 - 4. +

Q.8 Which tab in Microsoft Word 365 contains the 'Open' option to open an existing document?

- Ans
- 1. File
 - 2. View
 - 3. Insert
 - 4. Home

Q.9 Which of the following is used to select an entire line or paragraph from the cursor place in MS-Word 365?

- Ans
- 1. Both single and double mouse click
 - 2. Triple mouse click
 - 3. Single mouse click
 - 4. Double mouse click

Q.10 'Contact Us' is present in which of the following sections in MS Word 365?

- Ans
- 1. Help
 - 2. References
 - 3. Review
 - 4. Mailings

Prepare 50% Faster

Constable Executive Male and Female in Delhi Police Examination 2023

Exam Date	23/11/2023
Exam Time	3:00 PM - 4:30 PM
Subject	Constable Executive Male and Female in Delhi Police Examination 2023

Section : General Knowledge

Q.1 The practice of sati was made illegal and punishable in the year 1829, under Governor-General _____.

- Ans**
- 1. Henry Hardinge
 - 2. Charles Metcalfe
 - 3. William Bentinck
 - 4. John Shore

Q.2 Pancha Mahal is located in which of these cities?

- Ans**
- 1. Ahmedabad
 - 2. Delhi
 - 3. Fatehpur Sikri
 - 4. Jaipur

Q.3 The 'Hanukkah' celebration is associated with which of the following communities?

- Ans**
- 1. Parsi
 - 2. Jewish
 - 3. Buddhist
 - 4. Jain

Q.4 For which of the following dance forms was Nalini Asthana awarded the Padma Shri in 2022?

- Ans**
- 1. Bharatanatyam
 - 2. Mohiniyattam
 - 3. Kathak
 - 4. Kathakali

Q.5 Which Article of the Constitution defines Advocate General as the legal advisor to a State Government?

- Ans**
- 1. Article 165
 - 2. Article 167
 - 3. Article 164
 - 4. Article 166

Q.6 A small enterprise is one in which investment in plant and machinery does NOT exceed what amount?

- Ans**
- 1. ₹5 crore
 - 2. ₹15 crore
 - 3. ₹10 crore
 - 4. ₹2 crore

Q.7 Tribal Welfare Ministers in Chhattisgarh, Jharkhand, Madhya Pradesh and Odisha are appointed by the _____

- Ans
- 1. Chief Minister
 - 2. Prime Minister
 - 3. Tribal Development Council
 - 4. Governor

Q.8 Which of the following unemployment types is the result of people voluntarily leaving jobs in search of better ones?

- Ans
- 1. Structural unemployment
 - 2. Cyclical unemployment
 - 3. Disguised unemployment
 - 4. Frictional unemployment

Q.9 According to the National Population Policy 2000, what is the target year for reaching stability in population?

- Ans
- 1. 2050
 - 2. 2070
 - 3. 2065
 - 4. 2045

Q.10 In which season do Western disturbances lead to rainfall in Northern states?

- Ans
- 1. Monsoon season
 - 2. Summer season
 - 3. Spring season
 - 4. Winter season

Q.11 Padma Bhushan 2022, awardee _____ is a Hindustani Classical musician.

- Ans
- 1. Geeta Chandran
 - 2. Madhuri Barthwal
 - 3. Victor Banerjee
 - 4. Rashid Khan

Q.12 Which of the following tribal dances is performed in Tripura by the Mog community?

- Ans
- 1. Hai-Hak
 - 2. Wangala
 - 3. Sangrai
 - 4. Hozagiri

Q.13 Shivnath Mishra is an exponent of Benaras Gharana and he plays the _____ .

- Ans
- 1. Tabla
 - 2. Rudra Veena
 - 3. Harmonium
 - 4. Sitar

Q.14 Bhuban Kumar of Purulia is an award-winning _____ dancer.

- Ans
- 1. Kuchipudi
 - 2. Chhau
 - 3. Kathakali
 - 4. Kathak

Q.15 According to Census 2011, which state of India has the lowest population?

- Ans**
- 1. Sikkim
 - 2. Goa
 - 3. Arunachal Pradesh
 - 4. Mizoram

Q.16 Which programme was restructured and renamed as 'National Rural Employment Programme'?

- Ans**
- 1. Integrated Rural Development Programme
 - 2. Rural Landless Employment Guarantee Programme
 - 3. National Institute of Rural Development
 - 4. Food for Work Programme

Q.17 Which of the following Articles pertain to the Right against Exploitation?

- Ans**
- 1. Articles 25-28
 - 2. Articles 14-18
 - 3. Articles 19-22
 - 4. Articles 23-24

Q.18 In which two states is the Agasthyamala Biosphere Reserve located?

- Ans**
- 1. Kerala and Tamil Nadu
 - 2. Maharashtra and Gujarat
 - 3. Gujarat and Rajasthan
 - 4. Madhya Pradesh and Uttar Pradesh

Q.19 The term 'scoop' is used in which of the following sports?

- Ans**
- 1. Hockey
 - 2. Badminton
 - 3. Tennis
 - 4. Football

Q.20 In whose consultation does the President have the power to make rules to the procedure with respect to joint sittings of the two Houses?

- Ans**
- 1. Speaker and Members of Lok Sabha
 - 2. Chairman and members of Rajya Sabha
 - 3. Speaker, Chairman and Members of Parliament
 - 4. Chairman and Speaker

Q.21 What is the position of the earth called when it is farthest from the sun during its revolution?

- Ans**
- 1. Aphelion
 - 2. Abherilion
 - 3. Perihelion
 - 4. Aphelion

Q.22 Which of the following Iron and Steel Plants of India is situated on the coast of Bay of Bengal?

- Ans**
- 1. Bhadravati
 - 2. Vishakhapatnam
 - 3. Salem
 - 4. Durgapur

Q.23 During Chandragupta Maurya's reign, the administration of Pataliputra, which was the capital of the Mauryas was by how many committees?

- Ans
- 1. Three
 - 2. Four
 - 3. Six
 - 4. Eight

Q.24 The concept of 'Concurrent List' in the Constitution of India is borrowed from _____.

- Ans
- 1. Canada
 - 2. Japan
 - 3. Australia
 - 4. Germany

Q.25 In cricket, which of the following is considered as LBW?

- Ans
- 1. The fielder catches a ground ball and throws it at the wicket, knocking it down before the batsman gets there.
 - 2. The fielder catches a batted ball on the fly.
 - 3. The batsman's body interferes with a bowled ball that would hit the wicket.
 - 4. The bowler knocks over (or, breaks) the wicket with a bowl.

Q.26 What is used to make transparent soaps?

- Ans
- 1. Sodium chloride
 - 2. Sodium carbonate
 - 3. Rosin
 - 4. Ethanol

Q.27 As per the 2nd Advance Estimate of the Ministry of Agriculture and Farmers Welfare, the record foodgrains production of _____ million tonnes is estimated in India in the year 2021-22.

- Ans
- 1. 378.54
 - 2. 316.06
 - 3. 420.78
 - 4. 501.16

Q.28 What is the full form of 'BPO'?

- Ans
- 1. Business Process Outsourcing
 - 2. Business Product Outsourcing
 - 3. Business Process Outcome
 - 4. Buying Process Outsourcing

Q.29 Delhi first became the capital of a kingdom during the reign of the _____.

- Ans
- 1. Tuglaqs
 - 2. Tomara Rajputs
 - 3. Mamluks
 - 4. Chauhans

Q.30 Which of the following Trophies/Cups is related to football?

- Ans
- 1. Davis Cup
 - 2. Ranji Trophy
 - 3. Sultan Azlan Shah Cup
 - 4. Santosh Trophy

Q.31 Who is the main architect of Shri Ram Mandir of Ayodhya?

- Ans
- 1. Ram Suthar
 - 2. Chitra Vishwanath
 - 3. Sashi Prabhu
 - 4. Chandrakant Bhai Sompura

Q.32 The famous Hindi novel 'Suraj Ka SatvanGhoda' is written by:

- Ans
- 1. Dharmveer Bharati
 - 2. Phanishwar Nath Renu
 - 3. Sri Lal Shukla
 - 4. Kamleshwar

Q.33 Biswa and Phulaich are the cultural festivals of _____.

- Ans
- 1. Karnataka
 - 2. Bihar
 - 3. Himachal Pradesh
 - 4. West Bengal

Q.34 Which of the following led to reservation of industrial activities for private and public sectors for the first time in India?

- Ans
- 1. The Industrial Policy Resolution, 1948
 - 2. The Statement of Industrial Policy, 1945
 - 3. Industrial Policy Resolution, 1956
 - 4. Industries Development and Regulation Act, 1951

Q.35 Typhoid is caused by _____.

- Ans
- 1. bacteria
 - 2. Fungi
 - 3. Virus
 - 4. Protozoa

Q.36 Which of the following Articles of the Constitution of India says that a State shall not deny equal protection of the laws within the territory of India?

- Ans
- 1. Article 11
 - 2. Article 12
 - 3. Article 14
 - 4. Article 13

Q.37 Which of the following is a biological name for a Housefly?

- Ans
- 1. Triticum aestivum
 - 2. Poaceae
 - 3. Musca domestica
 - 4. Primata

Q.38 The author of the book 'My Music, My Life' is the famous Sitar player. Who is he?

- Ans
- 1. Ravi Shankar
 - 2. Brij Narayan
 - 3. Zakir Hussain
 - 4. Hari Prasad Chaurasia

Q.39 Which Act led to the shift from curbing competition to promoting competition in the market?

- Ans**
- 1. MRTP Act 1969
 - 2. Banking Regulation Act 1949
 - 3. Copra Act
 - 4. Competition Act 2002

Q.40 Who among the following Delhi-based Bharatanatyam dancers received the Nritya Perunjyothi award for the year 2021?

- Ans**
- 1. Geeta Chandran
 - 2. Pandit Birju Maharaj
 - 3. Chitra Visweswaran
 - 4. Lakshmi Vishwanathan

Q.41 Who was known as 'Zinda Pir'?

- Ans**
- 1. Humayun
 - 2. Akbar
 - 3. Aurangzeb
 - 4. Babur

Q.42 Suryoday Small Finance Bank is the company from _____ to obtain a 'small finance bank' license from the Reserve Bank of India.

- Ans**
- 1. Andhra Pradesh
 - 2. Gujarat
 - 3. Maharashtra
 - 4. Madhya Pradesh

Q.43 In which of the following years was the Gandhi-Irwin Pact signed with the government agreeing to release all political prisoners?

- Ans**
- 1. 1929
 - 2. 1931
 - 3. 1930
 - 4. 1928

Q.44 Which Article empowers the Supreme Court to issue directions or writs for the enforcement of Fundamental Rights?

- Ans**
- 1. Article 32
 - 2. Article 30
 - 3. Article 31
 - 4. Article 29

Q.45 When was Dev Samaj established?

- Ans**
- 1. 1902
 - 2. 1860
 - 3. 1850
 - 4. 1887

Q.46 Bindusara was the successor of which of the following Mauryan emperors?

- Ans**
- 1. Ashoka
 - 2. Chandragupta Maurya
 - 3. Shalishuka
 - 4. Devavarman

Q.47 Which of the following statements is/are true about Regional Rural Banks?
 I. RRBs were established in 1977.
 II. The Government of India contributes 50% of the share capital of RRB.
 III. Narasimham Committee recommended the amalgamation of RRBs.

- Ans
- 1. Only III
 - 2. Only II and III
 - 3. Only II
 - 4. Only I

Q.48 In which of the following years did Mahatma Gandhi lead the Dandi March?

- Ans
- 1. 1930
 - 2. 1919
 - 3. 1914
 - 4. 1918

Q.49 The number of players playing in a team in the T20 cricket match is _____.

- Ans
- 1. 10
 - 2. 11
 - 3. 12
 - 4. 13

Q.50 Upon application of heat energy, the atoms of an ice cube start vibrating. At one point, the atoms have so much energy that they break away from their fixed position and loose the fixed structure. We can see this as the formation of water. What is this particular point called?

- Ans
- 1. Decomposition temperature
 - 2. Melting point
 - 3. Boiling point
 - 4. Softening point

Section : Reasoning

Q.1 Select the figure that will replace the question mark (?) in the following figure series.



- Ans
- 1.
 - 2.
 - 3.
 - 4.

Q.2 Select the option that is related to the fourth number in the same way as the first number is related to the second number and the fifth number is related to the sixth number.
 $252 : 6 :: ? : 9 :: 1872 : 12$

- Ans
- 1. 750
 - 2. 729
 - 3. 810
 - 4. 829

Q.3 In this question, Figure X is followed by four figures, numbered (1), (2), (3) and (4). Select the option in which Figure X is embedded.



(X)

Ans

✗ 1.



✓ 2.



✗ 3.

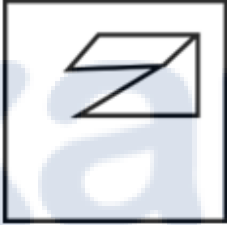

✗ 4.



Q.4 Find out the figure amongst the four option in which figure X is embedded (Rotation is not allowed)

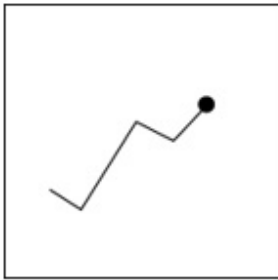

(X)

Ans

✗ 1.

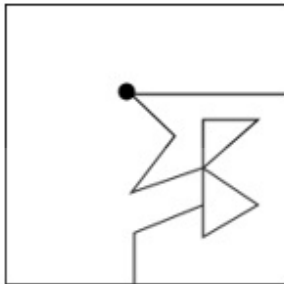

✗ 2.

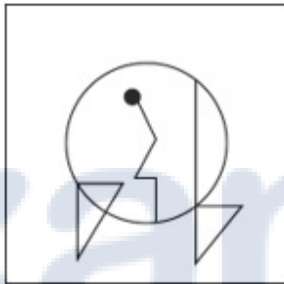

✗ 3.

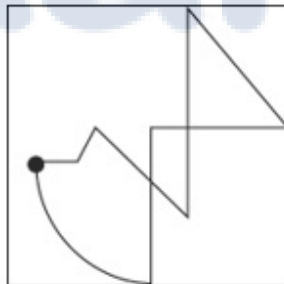

✓ 4.

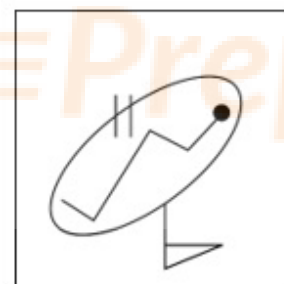

Q.5 Select the word-pair that best represents a similar relationship to the one expressed in the pair of words given below. (The words must be considered as meaningful English words and must not be related to each other based on the number of letters/number of consonants/vowels in the word)

Seismology : Earthquakes

- Ans
- ✓ 1. Ornithology : Birds
 - ✗ 2. Entomology : Bone
 - ✗ 3. Paedology : Plants
 - ✗ 4. Craniology : Muscle

Q.6 Select the correct combination of mathematical signs to sequentially replace the * signs and to balance the given equation $34 * 58 * 2 * 96 * 4 = 29$

- Ans
- 1. $\times, \div, +, -$
 - 2. $-, \div, +, \div$
 - 3. $+, \times, -, \div$
 - 4. $\div, \times, +, -$

Q.7 Select the figure from the options that can replace the question mark (?) and complete the given pattern so that final image is symmetrical.

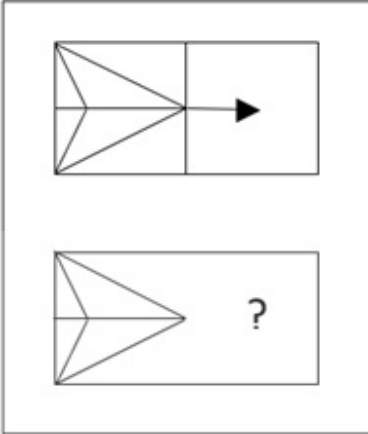

- Ans
- 1.
 - 2.
 - 3.
 - 4.

Q.8 Select the number from among the given options that can replace the question mark (?) in the following series.

6, 14, 46, 174, 686, ?

- Ans
- 1. 3232
 - 2. 2734
 - 3. 897
 - 4. 344

Prepare 50% Faster

Q.9 Select the correct mirror image of the given combination when the mirror is placed at 'MN' as below.

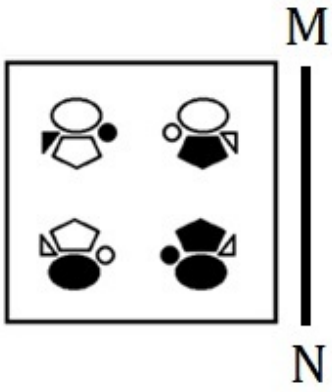

Ans

✗ 1.

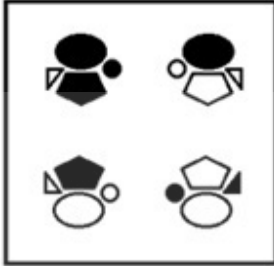

✗ 2.

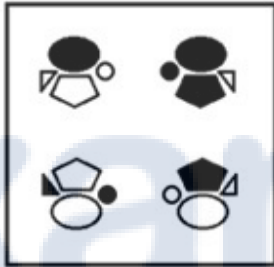

✗ 3.



✓ 4.

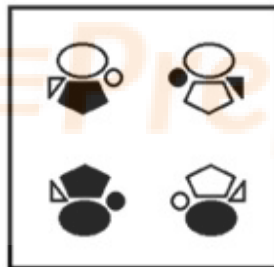

Q.10 Select the correct mirror image of the given combination when the mirror is placed at 'PQ' as shown below.



- Ans
- ✓ 1. U 9 Y R 5 M
 - ✗ 2. U 9 Y R 5 M
 - ✗ 3. U 9 Y R 5 M
 - ✗ 4. U 9 Y R 5 M

Q.11 Select the option that represents the letters that, when sequentially placed from left to right in the blanks below, will complete the letter series.

C _ _ D F _ A S _ F _ A S D _ C A _ D _

- Ans
- ✓ 1. ASCDCFSF
 - ✗ 2. ASCDFCSF
 - ✗ 3. ASCDCDSF
 - ✗ 4. ASCDCSSF

Q.12 Select the option in which the given figure is embedded (rotation is NOT allowed).



- Ans
- ✗ 1.
 - ✗ 2.
 - ✓ 3.
 - ✗ 4.

Q.13 Select the option figure that is embedded in the given figure (rotation is NOT allowed).

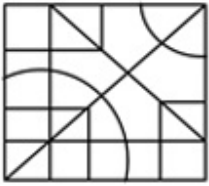

Ans

- 1.
- 2.
- 3.
- 4.

Q.14 Which figure should replace the question mark (?) if the series were to be continued?

P	A	S	T	E	H	A	R	T	Z	Z	T	A	R	H	V	T	O	R	C	?
---	---	---	---	---	---	---	---	---	---	---	---	---	---	---	---	---	---	---	---	---

Ans

- 1.

C	R	O	T	V
---	---	---	---	---
- 2.

C	O	R	T	V
---	---	---	---	---
- 3.

C	V	T	O	R
---	---	---	---	---
- 4.

C	R	T	O	V
---	---	---	---	---

Q.15 A paper is folded and cut as shown below. How will it appear when unfolded?

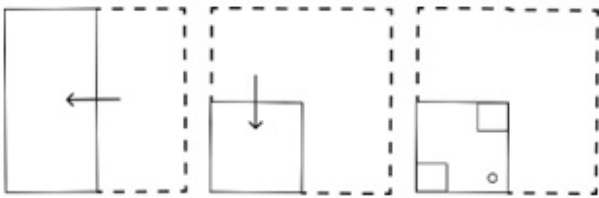

Ans

X 1.

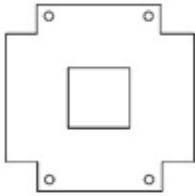

X 2.

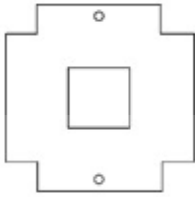

✓ 3.

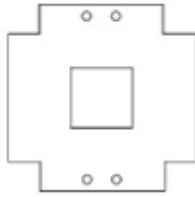

X 4.

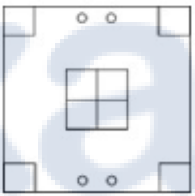

Q.16 Read the given statements and conclusions carefully. Assuming that the information given in the statements is true, even if it appears to be at variance with commonly known facts, decide which of the given conclusions logically follow(s) from the statements.

Statements:

Some soldiers are officers.

Some officers are civilians.

Conclusions:

I. All soldiers are civilians.

II. All civilians are soldiers.

Ans ✓ 1. Neither conclusion I nor II follows

X 2. Only conclusion II follows

X 3. Both conclusions I and II follow

X 4. Only conclusion I follows

Q.19 In a certain code language, 'COMPUTER' is written as 'DQNRVVFT' and 'GARDENER' is written as 'HCSFFPFT'. How 'ACADEMIC' be written as in that language?

- Ans
- ✓ 1. BEBFFOJE
 - ✗ 2. BFBFFOJE
 - ✗ 3. BECFFOJE
 - ✗ 4. BEBEFOJE

Q.20 Select the option figure that will replace the question mark (?) in the figure given below to complete the pattern.

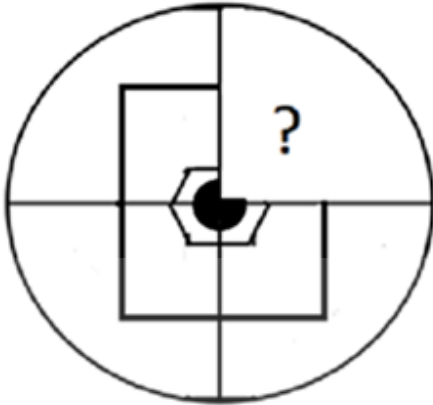

Ans

- ✗ 1.
- ✓ 2.
- ✗ 3.
- ✗ 4.

Q.21 A dice with six faces is marked with six numbers 1, 2, 3, 4, 5 and 6, respectively. It is rolled 2 times and lands on the positions shown below. Which number is on the opposite plane of 2?

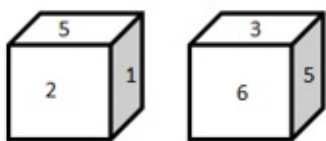

- Ans
- ✓ 1. 3
 - ✗ 2. 4
 - ✗ 3. 1
 - ✗ 4. 5

Q.22 Six students are sitting around a circular table facing the centre. Dipan is an immediate neighbour of both Hansika and Gargi. Ekansh is sitting second to the left of Gargi. Iman is sitting third to the right of Hansika. Firoz is an immediate neighbour of both Ekansh and Hansika. Who is an immediate neighbour of both Dipan and Iman?

- Ans**
- 1. Firoz
 - 2. Gargi
 - 3. Ekansh
 - 4. Hansika

Q.23 How many squares are there in the given figure?

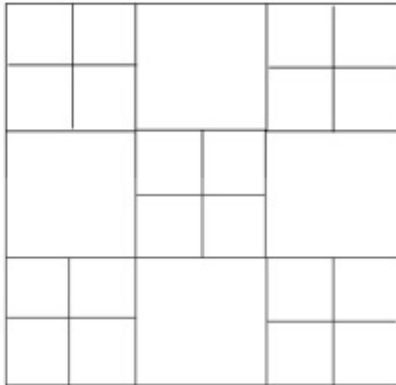

- Ans**
- 1. 32
 - 2. 34
 - 3. 30
 - 4. 36

Q.24 Three different positions of the same cube are shown. Which number is on the opposite side of 4?

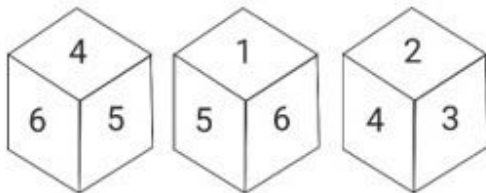

- Ans**
- 1. 5
 - 2. 1
 - 3. 3
 - 4. 2

Q.25 Select the correct combination of mathematical signs that can sequentially replace the * signs and balance the given expression.
 $55 * 11 * 7 * 9 * 32 * 36$

- Ans**
- 1. $\times, +, -, \div, =$
 - 2. $+, -, \times, \div, =$
 - 3. $+, \times, -, =, \div$
 - 4. $\div, +, \times, -, =$

Section : Numerical Ability

Q.1 A policeman chases a thief who is at a distance of 450 metres from him. The thief starts running at a speed of 9 km/h. At the moment he sees the policeman. The policeman gives chase immediately with a speed of 12 km/h. Eventually, the thief is caught. What is the distance (in km) run by the thief?

- Ans**
- 1. 1.35
 - 2. 1.65
 - 3. 1.25
 - 4. 1.55

Q.2 The product of two numbers is 2028 and their HCF is 13. Find their LCM.

- Ans**
- 1. 142
 - 2. 156
 - 3. 186
 - 4. 168

Q.3 A shopkeeper sells an article for ₹360 after allowing a discount of 10%. What would have been its selling price (in ₹) had he offered a discount of 20%?

- Ans**
- 1. 300
 - 2. 320
 - 3. 340
 - 4. 290

Q.4 Rewa misread the number 45 as 54. Find the percentage increase or decrease in this process.

- Ans**
- 1. 20% increase
 - 2. 15% increase
 - 3. 15% decrease
 - 4. 20% decrease

Q.5 Kumar invested a total of ₹16,900 partly in two schemes, A and B. The rate of simple interest in the two schemes were 14% p.a. and 11% p.a., respectively. If the total interest earned in 2 years was ₹4,498, then what was the amount invested in Scheme B?

- Ans**
- 1. ₹3,200
 - 2. ₹4,900
 - 3. ₹3,000
 - 4. ₹3,900

Q.6 The diameter of a right circular cone is 14 cm, while its slant height is 11 cm. What is the volume of the cone? (Use $\pi = \frac{22}{7}$)

- Ans**
- 1. $108\sqrt{2} \text{ cm}^3$
 - 2. $208\sqrt{2} \text{ cm}^3$
 - 3. $407\sqrt{3} \text{ cm}^3$
 - 4. $308\sqrt{2} \text{ cm}^3$

Q.7 What must be the total percentage change (rounded off to 1 decimal place) in the volume of a cuboid if its length and breadth are increased by 24% and 45%, respectively, while its height is decreased by 55%?

- Ans**
- 1. Decrease, 19.1%
 - 2. Increase, 19.1%
 - 3. Increase, 14.9%
 - 4. Decrease, 14.9%

Q.8 If $5.5x = 0.05y$, then the value of $\frac{y - 3x}{y + 3x}$ is:

- Ans
- 1. $\frac{107}{117}$
 - 2. $\frac{111}{113}$
 - 3. $\frac{103}{113}$
 - 4. $\frac{107}{113}$

Q.9 An item was sold at a profit of 23.75%. If the cost price of the item was ₹1,000 more than what it actually was, while the selling price remained unchanged, the profit earned would have been only 10%. What was the actual cost price of the item (in ₹)?

- Ans
- 1. 8000
 - 2. 8600
 - 3. 7500
 - 4. 8500

Q.10 Rama's marks in two subjects, mathematics and physics, are in the ratio 8 : 13. If he got 25 marks more in physics than in mathematics, what are his marks in mathematics?

- Ans
- 1. 30
 - 2. 35
 - 3. 25
 - 4. 40

Q.11 A garrison of 1200 men has provisions for 15 days. How long will the provisions last if the garrison is increased by 600 men?

- Ans
- 1. 12 days
 - 2. 10 days
 - 3. 14 days
 - 4. 6 days

Q.12 Find the total surface area (in cm^2) of a cylinder with the diameter of base 21 cm and height 42 cm.

(Take $\pi = \frac{22}{7}$)

- Ans
- 1. 3456
 - 2. 3450
 - 3. 3480
 - 4. 3465

Q.13 The difference (in ₹, to the nearest integer) between the simple interest and the compound interest on ₹3,660 for one and a half years at 10% per annum, compounded half-yearly, is:

- Ans
- 1. 49
 - 2. 36
 - 3. 42
 - 4. 28

Q.14 Which of the following numbers is a prime number?

- Ans
- 1. 901
 - 2. 917
 - 3. 1049
 - 4. 1047

Q.15 A man bought 16 articles at ₹85 each, 15 at ₹65 each, and 12 at ₹75 each. What is the average price of each article? (Up to two places of decimal)

- Ans
- 1. ₹72.65
 - 2. ₹75.23
 - 3. ₹77.65
 - 4. ₹69.87

Section : Computer Proficiency

Q.1 In MS Excel 365, the title bar in Microsoft Excel is used for:

- Ans
- 1. displaying the title of a sheet
 - 2. displaying the title of a workbook
 - 3. displaying the title of a column
 - 4. displaying the title of a row

Q.2 In MS Word 365, which of the following shortcut is used to centre align the selected text?

- Ans
- 1. Ctrl + C
 - 2. Ctrl + E
 - 3. Ctrl + Shift + E
 - 4. Ctrl + Shift + C

Q.3 You have created a new document in MS Word 365 and you have made some changes to it. You want to save the document, but you also want to create a copy of it with a different name. Which of the following commands should you use?

- Ans
- 1. Open
 - 2. Close
 - 3. Save As
 - 4. Save

Q.4 Which of the following keyboard shortcuts is/are used to open the Find and Replace dialog box in MS Word 365?
a) Ctrl + H
b) Ctrl + R

- Ans
- 1. Only (a)
 - 2. Both (a) and (b)
 - 3. Only (b)
 - 4. Neither (a) nor (b)

Q.5 Which of the following is a simple function in MS Excel 365, that raises a given number to an exponent?

- Ans
- 1. MEDIAN
 - 2. AVERAGE
 - 3. RAND
 - 4. POWER

Q.6 In Microsoft Excel, letters of the alphabet are used to define which of the following?

- Ans
- 1. Row
 - 2. Table
 - 3. Column
 - 4. Sheet

Q.7 What action is performed by pressing the 'Delete' key on the keyboard in Microsoft Word 365?

- Ans
- 1. Removes the selected text
 - 2. Cuts the selected text
 - 3. Undo the last action
 - 4. Copies the selected text

Q.8 Which architecture connects individual devices directly, with equal responsibilities and powers, and without a central authority?

- Ans
- 1. Peer-to-Peer architecture
 - 2. Client-Server architecture
 - 3. Centralised architecture
 - 4. Distributed architecture

Q.9 _____ can help detect spelling and grammatical errors in Microsoft Word 365.

- Ans
- 1. Pressing 'F7'
 - 2. Pressing 'F8'
 - 3. Pressing 'Alt+ F7'
 - 4. Pressing 'Alt+ F8'

Q.10 Any message you are writing until you send it or trash it, is called:

- Ans
- 1. Starred Mail
 - 2. Draft Mail
 - 3. Sent Mail
 - 4. Received Mail

Prepare 50% Faster

Constable Executive Male and Female in Delhi Police Examination 2023

Exam Date	24/11/2023
Exam Time	9:00 AM - 10:30 AM
Subject	Constable Executive Male and Female in Delhi Police Examination 2023

Section : General Knowledge

Q.1 The first female sultan of Delhi sultanate, Raziyya Sultana, was the daughter of _____.

- Ans**
- 1. Shamsuddin Iltutmish
 - 2. Muhammad Tughluq
 - 3. Qutbuddin Aybak
 - 4. Muhammad Ghori

Q.2 What does 'F' stand for in FII?

- Ans**
- 1. Fiduciary
 - 2. Foreign
 - 3. Fund
 - 4. Fast

Q.3 As a result of the green revolution, India was able to change its status from _____

- Ans**
- 1. an agricultural nation to a manufacturing nation
 - 2. a developing nation to a developed nation
 - 3. a slow growing nation to the fastest growing nation in the world
 - 4. a food deficient country to a leading agricultural nation

Q.4 In which state of India is shifting cultivation known as Pamlou?

- Ans**
- 1. Manipur
 - 2. Madhya Pradesh
 - 3. Odisha
 - 4. Andhra Pradesh

Q.5 As of July 2023, which of the following dances from Kerala has been given a classical status by the Indian government?

- Ans**
- 1. Kolkali
 - 2. Velakali
 - 3. Thiruvathirakali
 - 4. Mohiniyattam

Q.6 Who wrote 'The Story of My Experiments with Truth'?

- Ans**
- 1. Gopal Krishna Gokhale
 - 2. Jawaharlal Nehru
 - 3. Mohandas Karamchand Gandhi
 - 4. Bal Gangadhar Tilak

Q.7 On which date in 1991 was the Indian rupee devalued?

- Ans
- 1. 15th October
 - 2. 1st January
 - 3. 30th July
 - 4. 1st July

Q.8 Who among the following was an awardee of the prestigious National Nritya Shiromani Award 2022?

- Ans
- 1. Aparna Satheesan
 - 2. ShanthaDhanajayan
 - 3. Alarmel Valli
 - 4. VP Dhananjayan

Q.9 To solve the balance of payment crisis in 1991, the Indian Rupee was _____ against foreign currencies.

- Ans
- 1. appreciated
 - 2. undervalued
 - 3. depreciated
 - 4. devalued

Q.10 Molten state and very high-temperature are important criteria for the formation of which type of rocks?

- Ans
- 1. Sedimentary rocks
 - 2. Igneous rocks
 - 3. Metamorphic rocks
 - 4. Sphalerite ore rocks

Q.11 Who among the following won a Grammy Award for 'A Colorful World' in the Best Children's Album category in 2022?

- Ans
- 1. Falguni Shah
 - 2. Tatyana Ali
 - 3. Monica Dogra
 - 4. Raveena Aurora

Q.12 Who among the following received the Padma Shri in 2022 for performing the Rai folk dance form of Madhya Pradesh?

- Ans
- 1. Ram Sahay Pandey
 - 2. Sheesh Ram
 - 3. AKC Natrajan
 - 4. Balesh Bhajantri

Q.13 The salary, allowances and pension of the Comptroller and Auditor General of India is charged upon _____.

- Ans
- 1. Public Account
 - 2. Consolidated Fund of State
 - 3. Consolidated Fund of India
 - 4. Contingency Fund of India

Q.14 What is the minimum strength of the Legislative Council?

- Ans
- 1. 60 members
 - 2. 100 members
 - 3. 40 members
 - 4. 15 members

Q.15 Which of the following social reformers is credited with the establishment of 'Bharat Stree Mahamandal' in 1910?

- Ans
- 1. Sarojini Naidu
 - 2. Usha Mehta
 - 3. Sarala Devi Chaudhurani
 - 4. Savitri Bai Phule

Q.16 Which of the following is a salient feature of the Indian Constitution?

- Ans
- 1. It is the shortest written Constitution in the world.
 - 2. It was adopted before India got independence.
 - 3. It is not a written Constitution.
 - 4. It is the longest written Constitution in the world.

Q.17 The legendary Kuchipudi dancer and Padma Shri 1970 awardee, V Satyanarayana Sarma was born in _____ .

- Ans
- 1. Andhra Pradesh
 - 2. Kerala
 - 3. Tamil Nadu
 - 4. Karnataka

Q.18 The rate of change of momentum of an object is proportional to the applied unbalanced force in the direction of force. This is known as:

- Ans
- 1. second law of motion
 - 2. law of inertia
 - 3. third law of motion
 - 4. first law of motion

Q.19 Which of the following authors has written the great English novel 'Moby-Dick'?

- Ans
- 1. Herman Melville
 - 2. Wilkie Collins
 - 3. Nathaniel Hawthorne
 - 4. Thomas Hardy

Q.20 Select the most appropriate option with respect to the correctness of the following statements.

- a) The northern plains are a densely populated physiographic division.
b) The plains have rich soil cover combined with adequate water supply and favourable climate, it is agriculturally a productive part of India.

- Ans
- 1. Both a and b are correct
 - 2. Both a and b are incorrect
 - 3. Only a is correct
 - 4. Only b is correct

Q.21 The historic Asamai temple is located in _____ in Afghanistan.

- Ans
- 1. Kabul
 - 2. Ghazni
 - 3. Kandahar
 - 4. Feyzabad

Q.22 Muhammad Yunus, one of the pioneers in microfinance, founded Grameen Bank in which year?

- Ans
- 1. 1975
 - 2. 1983
 - 3. 1989
 - 4. 1990

Q.23 As per census 2011, which of the following states has the highest scheduled caste population?

- Ans**
- 1. Uttar Pradesh
 - 2. West Bengal
 - 3. Tamil Nadu
 - 4. Bihar

Q.24 Who was the first Indian to be elected to the Communist International leadership class?

- Ans**
- 1. Jawaharlal Nehru
 - 2. Lala Lajpat Rai
 - 3. Shripad Amrit Dange
 - 4. Manvendra Nath Roy

Q.25 In which year did the first Khelo India School Games start?

- Ans**
- 1. 2018
 - 2. 2016
 - 3. 2015
 - 4. 2017

Q.26 Table sugar mostly contains:

- Ans**
- 1. maltose
 - 2. fructose
 - 3. glucose
 - 4. sucrose

Q.27 Whom did Gopal Krishna Gokhale call 'the best ambassador of Hindu-Muslim unity'?

- Ans**
- 1. Mohammad Ali Jinnah
 - 2. Maulana Abul Kalam Azad
 - 3. Jawaharlal Nehru
 - 4. Mahatma Gandhi

Q.28 'Beri-Beri' is caused by the deficiency of _____.

- Ans**
- 1. thiamine
 - 2. Riboflavin
 - 3. Cyanocobalamin
 - 4. Niacin

Q.29 What is the name of the mascot for the fourth Khelo India Games?

- Ans**
- 1. Vijaya
 - 2. Veera
 - 3. Dhakad
 - 4. Jaya

Q.30 In a 100 m Relay Race, how many athletes have to complete a race?

- Ans**
- 1. 6
 - 2. 2
 - 3. 3
 - 4. 4

Q.31 The total replenishable groundwater resource in the country is about 432 cubic km. Accordingly, which water body contains 26.55% of the total replenishable groundwater resource?

- Ans**
- 1. Brahmaputra
 - 2. Mahanadi
 - 3. Godavari
 - 4. Kaveri

Q.32 Which of the following festivals of Mizoram is celebrated to promote horticulture?

- Ans**
- 1. Anthurium
 - 2. Hlukkha Kut
 - 3. Lyuva Khutla
 - 4. Khuado Kut

Q.33 Who built the famous stupa of Bharhut originally?

- Ans**
- 1. Maurya
 - 2. Satavahana
 - 3. Sunga
 - 4. Kushan

Q.34 Which of the following statements is/are correct regarding the festival Holi?

- A. The night before Holi, bonfires are lit and people circumambulate the fire, which symbolises the end of Holika.
- B. The festival marks the beginning of Autumn.
- C. The festival of Holi is celebrated in the month of Magha masa (Hindu calendar).

- Ans**
- 1. A,B and C
 - 2. A and C only
 - 3. B and C only
 - 4. A only

Q.35 Who decides the disqualification of members of State Legislative Assembly, for matters other than those in the Tenth Schedule of the Constitution of India?

- Ans**
- 1. Chief Minister
 - 2. High Court
 - 3. Governor
 - 4. State Election Commission

Q.36 Which neighbouring country has emerged as the top destination of wheat exports from India in 2020-21, with the largest share of over 54 per cent both in terms of quantity and value?

- Ans**
- 1. Sri Lanka
 - 2. Bhutan
 - 3. Bangladesh
 - 4. Nepal

Q.37 Which physical component is required for transfer of antherozoids?

- Ans**
- 1. Air
 - 2. Light
 - 3. Water
 - 4. Soil

Q.38 During the sixth century BCE, as part of the 'Shraman' tradition, which of the following new religious and social r began in the Gangetic valley?

- Ans**
- 1. Sufism
 - 2. Christianity
 - 3. Buddhism
 - 4. Islam

Q.39 The term 'protectionist policy' in the industrial sector in the pre-1990 India refers to _____.

- Ans**
- 1. protecting public sector companies from domestic private sector companies
 - 2. protecting private companies from incurring losses
 - 3. protecting private sector companies from the competition of public sector companies
 - 4. protecting domestic companies from the competition of foreign companies

Q.40 In India, seasonal unemployment is predominantly associated with which field?

- Ans**
- 1. Agriculture
 - 2. Surface Transport
 - 3. Space and Technology
 - 4. Mining Industry

Q.41 Interest received is a factor income from _____.

- Ans**
- 1. Capital
 - 2. entrepreneurship
 - 3. land
 - 4. Labour

Q.42 Where is the tomb of Mohammad Ghaus located?

- Ans**
- 1. Agra
 - 2. Gwalior
 - 3. Burhanpur
 - 4. Delhi

Q.43 In despair because of the perpetuation of untouchability in Hindu doctrine, BR Ambedkar converted to _____ .

- Ans**
- 1. Christianity
 - 2. Buddhism
 - 3. Islam
 - 4. Jainism

Q.44 With which of the following rights do Articles 23 and 24 of the Indian Constitution deal with?

- Ans**
- 1. Right to Equality
 - 2. Right to Constitutional Remedies
 - 3. Right to Freedom of Religion
 - 4. Right Against Exploitation

Q.45 Which kind of emergency is imposed on the grounds of threat to the economic stability or credit of India?

- Ans**
- 1. Internal Emergency
 - 2. President's Rule
 - 3. National Emergency
 - 4. Financial Emergency

Q.46 उत्तर भारतीय मंदिर वास्तुकला के शीर्ष पर सपाट गोल (स्टोन-डिस्क) संरचना के लिए निम्नलिखित में से किस शब्द का उपयोग किया जाता है?

- Ans
- 1. कलश (Kalasha)
 - 2. अमलक (Amalaka)
 - 3. अंतराल (Antarala)
 - 4. शिखर (Shikhara)

Q.47 Which Article of the Indian Constitution guarantees the right to manage religious affairs?

- Ans
- 1. Article 27
 - 2. Article 26
 - 3. Article 28
 - 4. Article 25

Q.48 In karate, the fight starts when the referee shouts "_____".

- Ans
- 1. Shobu Hajime!
 - 2. Yame
 - 3. Kaizen
 - 4. Yuko

Q.49 Who among the following was the author of Kitab-ul-Hind based on India?

- Ans
- 1. Abdur Razzak
 - 2. Marco Polo
 - 3. Al Masudi
 - 4. Al Beruni

Q.50 In which year was MS Subbulakshmi honoured with the Bharat Ratna?

- Ans
- 1. 1995
 - 2. 1998
 - 3. 1996
 - 4. 1997

Section : Reasoning

Prepare 50% Faster

Q.1 Select the option figure that is embedded in the given figure. (Rotation is not allowed).

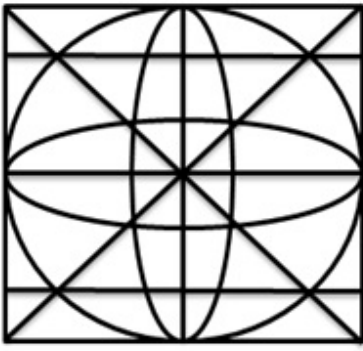

Ans

X 1.



X 2.

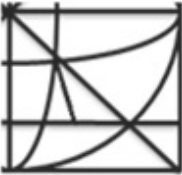

✓ 3.



X 4.

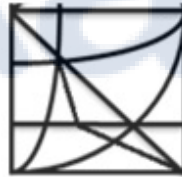

Prepare 50% Faster

Q.2 Select the figure from among the given options that can replace the question mark (?) in the following series.

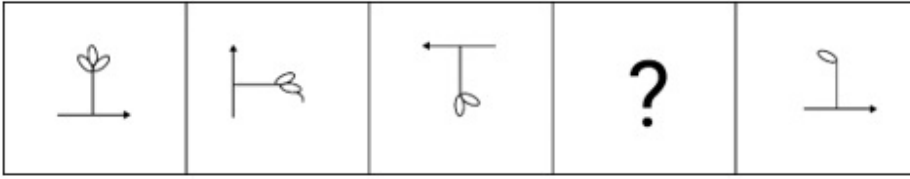

Ans

X 1.

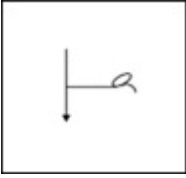

X 2.

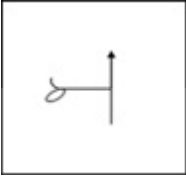

✓ 3.

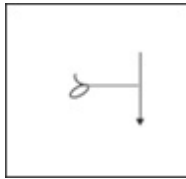

X 4.



Prepare 50% Faster

Q.3 Select the correct mirror image of the given combination when the mirror is placed at 'MN' as shown below.

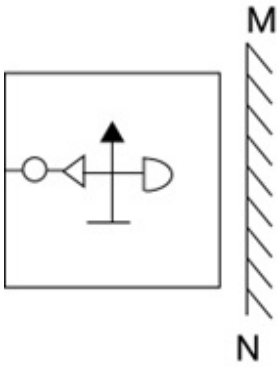

Ans

✗ 1.

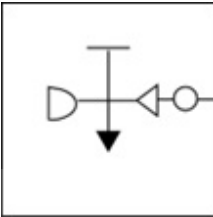

✗ 2.

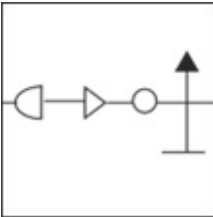

✓ 3.

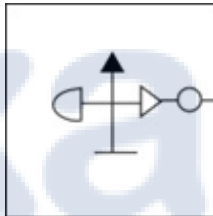

✗ 4.

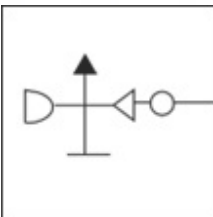

Q.4 A paper is folded and cut as shown below. How will it appear when unfolded?

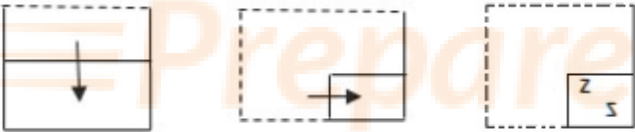

Ans

✓ 1.

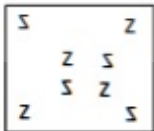

✗ 2.

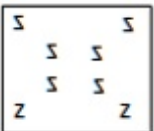

✗ 3.

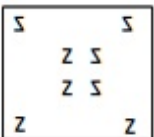

✗ 4.

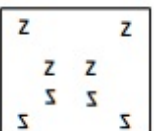

Q.5 Select the option that is embedded in the given figure (rotation is NOT allowed).

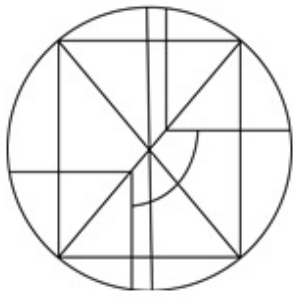

Ans

✓ 1.

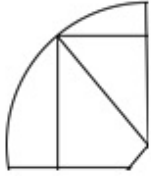

✗ 2.

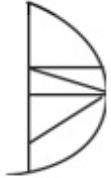

✗ 3.



✗ 4.



Prepare 50% Faster

Q.6 Select the figure from among the given options that can replace the question mark (?) in the following series.

α R c 3	3 c + R a	c a ≠ 3 R	R 3 ≠ a c	?
(i)	(ii)	(iii)	(iv)	(v)

Ans

- ✗ 1.

&	λ
#	
@	ε
- ✗ 2.

&	λ
#	
@	e
- ✗ 3.

&	γ
#	
@	ə
- ✓ 4.

3	c
#	
R	a

Q.7 Select the correct mirror image of the given figure when the mirror is placed at MN as shown below.

S A H 7 B k v
 M ————— N

- ✗ 1. 2 V H 7 B K V
- ✗ 2. S A H 7 B K V
- ✗ 3. v k B 7 H A 2
- ✓ 4. 2 V H 7 B K V

Q.8 Select the correct combination of mathematical signs to replace the * signs and to balance the given equation.
 $111 * 87 * 78 * 3 * 25 * 2$

- ✗ 1. - + + x =
- ✗ 2. - + + x =
- ✗ 3. - + = x +
- ✓ 4. - + + = x

Q.9 In a certain code language, 'LENGTH' is written as 'QVOTIS' and 'REGARD' is written as 'KVVZKW'. How will 'NAT' written as in that language?

- Ans
- 1. OFJLPE
 - 2. HBERPX
 - 3. HPELSH
 - 4. OZIFKV

Q.10 Select the set in which the numbers are related in the same way as are the numbers of the following sets.

(NOTE : Operations should be performed on the whole numbers, without breaking down the numbers into its constituent digits. E.g. 13 – Operations on 13 such as adding /deleting /multiplying etc. to 13 can be performed. Breaking down 13 into 1 and 3 and then performing mathematical operations on 1 and 3 is not allowed.)
(32, 8, 72)
(56, 14, 126)

- Ans
- 1. (92, 23, 209)
 - 2. (90, 23, 207)
 - 3. (92, 21, 207)
 - 4. (92, 23, 207)

Q.11 Select the figure from the options that can replace the question mark (?) and complete the given pattern.

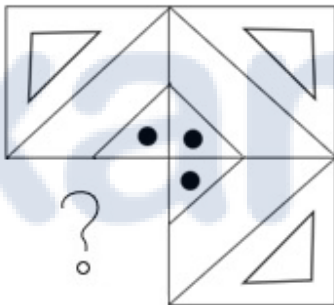

Ans

- 1.
- 2.
- 3.
- 4.

Q.12 How many triangles are there in the following figure?

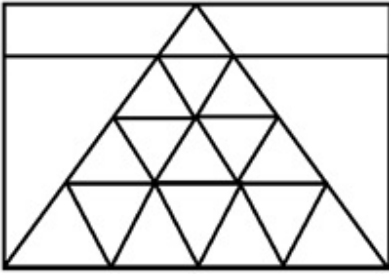

- Ans
- 1. 27
 - 2. 28
 - 3. 29
 - 4. 31

Q.13 Select the option in which the given figure is embedded (rotation is NOT allowed).

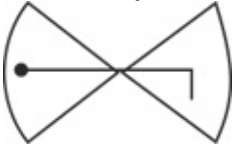

- Ans
- 1.
 - 2.
 - 3.
 - 4.

Prepare 50% Faster

Q.14 Which figure should replace the question mark (?) if the series were to be continued?

9	↑	↑	S	3	↑	↑	9	
D	I	S	K	3	9	I	D	D
3		O	O	K	K	I	I	S
								?

Ans

✗ 1.

I		↑	
D	K	3	O
S			9

✓ 2.

K		↑	
D	I	3	9
S			O

✗ 3.

I		S	
↑	O	3	9
K			D

✗ 4.

9		D	
↑	I	3	K
S			O

Q.15 Select the option in which the given figure is embedded (rotation is NOT allowed).



Ans

✗ 1.



✗ 2.



✗ 3.



✓ 4.



Q.16 Select the option that is related to the fourth number in the same way as the first number is related to the second number and the fifth number is related to the sixth number.
30 : 68 :: ? : 222 :: 10 : 30

Ans

✗ 1. 149

✗ 2. 150

✓ 3. 130

✗ 4. 125

Q.17 Select the word-pair that best represents a similar relationship to the one expressed in the pair of words given below. (The words must be considered as meaningful English words and must not be related to each other based on the letters/number of consonants/vowels in the word.)

Apes : Shrewdness

- Ans
- 1. Bears : Sleuth
 - 2. Tree : Leaves
 - 3. Lion : Fur
 - 4. Skin : Man

Q.18 Six letters J, K, L, M, N and O are written on different faces of a dice. Three different positions of this dice are shown in the figure. Select the letter that will be on the face opposite to the one having N.

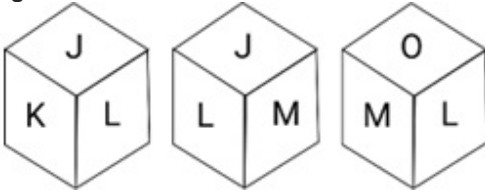

- Ans
- 1. M
 - 2. L
 - 3. J
 - 4. O

Q.19 Select the number from among the given options that can replace the question mark (?) in the following series.

1, 4, 10, 22, 46, ?

- Ans
- 1. 45
 - 2. 32
 - 3. 94
 - 4. 24

Q.20 Select the correct mirror image of the given figure when the mirror is placed at PQ as shown below.



- Ans
- 1. \$@#!@#YTR3WQ
 - 2. \$@#!@#YTR3WQ
 - 3. \$@#!@#TYR3WQ
 - 4. \$@#!@#YTR3MQ

Q.21 Which of the following terms will replace the question mark (?) in the given series?
YUN, URL, QOJ, ?, IIF

- Ans
- 1. MLH
 - 2. NLH
 - 3. MKI
 - 4. NKI

Q.22 Three statements are given, followed by three conclusions numbered 1, 2 and 3. Assuming the statements to be true, even if they seem to be at variance with commonly known facts, decide which of the conclusions logically follow(s) from the statements.

Statements:

1. Some locks are keys.
2. Some keys are blades.
3. No blade is a gum.

Conclusions:

1. No gum is a key.
2. No blade is a lock.
3. Some keys are locks.

- Ans
- 1. Only conclusions 1 and 2 follow
 - 2. Only conclusions 2 and 3 follow
 - 3. Only conclusion 3 follows
 - 4. Only conclusions 1 and 3 follow

Q.23 Select the correct mirror image of the given figure when the mirror is placed at 'AB' as shown.

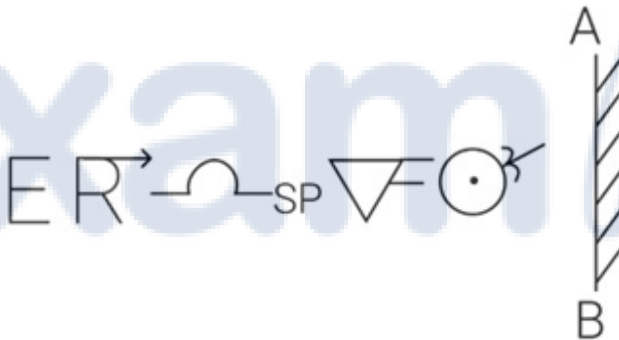

- Ans
- 1.
 - 2.
 - 3.
 - 4.

Q.24 Abhay, Bala, Chan, Dev, Emran, Fanny and Garry are 7 friends sitting around a circular table. Only five of them are facing the centre. Chan is sitting third to the left of Dev and both are facing the centre. Emran is the neighbour of neither Chan nor Dev. The one who is sitting exactly between Dev and Fanny is not facing the centre. Garry is sitting third to the right of Abhay and is facing the centre. One of the immediate neighbours of Bala is not facing the centre. Who is not sitting facing the centre?

- Ans
- 1. Fanny
 - 2. Bala
 - 3. Chan
 - 4. Emran

Q.25 Which two signs should be interchanged to make the given equation correct?
 $76 - 8 \times 97 + 32 \div 8 = 515$

- Ans
- 1. = and +
 - 2. + and ×
 - 3. × and -
 - 4. + and -

Section : Numerical Ability

Q.1 If the base of a triangle is L cm, height is (4L+7) cm and sum of the base and height is 37 cm, then find the area of the triangle.

- Ans
- 1. 75 cm^2
 - 2. 82 cm^2
 - 3. 105 cm^2
 - 4. 93 cm^2

Q.2 Find the average of the given numbers.
 3, 7, 9, -5, 0.25, -3.75

- Ans
- 1. 1.75
 - 2. 10.5
 - 3. 4.67
 - 4. 2.625

Q.3 The ratio of income and expenditure is 9:5. Income increases by 40% and expenditure decreases by 10%. If the initial income is ₹45,000 then the final saving (in ₹) is:

- Ans
- 1. 41,000
 - 2. 40,500
 - 3. 35,000
 - 4. 40,000

Q.4 The length of a rectangle is increased by 70% and its breadth is decreased by 35%. What is the net percentage increase in its area?

- Ans
- 1. 17.5%
 - 2. 35%
 - 3. 10.5%
 - 4. 14%

Q.5 If 42 workers earn ₹4,080 in 5 days, how much will 48 workers earn in 14 days?

- Ans
- 1. ₹13,198
 - 2. ₹6,128
 - 3. ₹6,528
 - 4. ₹13,056

Q.6 Find the value of $\frac{1 + 0.000027}{1 - 0.03 + 0.0009}$.

- Ans
- 1. 1.03
 - 2. 1.08
 - 3. 1.05
 - 4. 1.07

Q.7 In how many years will ₹7,81,250 amount to ₹9,13,952 at 4% compound interest?

- Ans
- 1. 4.5
 - 2. 4
 - 3. 3
 - 4. 3.5

Q.8 A loss of 25% gets converted into a profit of 12% when the selling price of an article is increased by ₹111. Find the cost price of the article.

- Ans
- 1. ₹300
 - 2. ₹290
 - 3. ₹295
 - 4. ₹305

Q.9 A boat can travel at a speed of 13 km/h in still water. If the speed of the stream is 4 km/h, then the time taken by boat to go 63 km in the opposite direction to stream is:

- Ans
- 1. 7 hours
 - 2. 9 hours
 - 3. 6 hours
 - 4. 5 hours

Q.10 The ratio of two numbers is 16:19 and their least common multiple is 59280. What are the two numbers?

- Ans
- 1. 3120 and 3705
 - 2. 3175 and 2123
 - 3. 3750 and 2130
 - 4. 5345 and 2298

Q.11 Find the value of $4\frac{2}{3} + 3\frac{1}{5} - 1\frac{1}{5}$.

- Ans
- 1. $5\frac{1}{2}$
 - 2. $5\frac{1}{3}$
 - 3. $6\frac{1}{4}$
 - 4. $6\frac{2}{3}$

Q.12 Under a scheme, a vendor is selling an article at a discount of 20% on the marked price; furthermore, he is offering a cash discount of ₹170. Now he is earning a profit of 10%. Determine the marked price of the article if its cost price is ₹1,300.

- Ans
- 1. ₹500
 - 2. ₹1,000
 - 3. ₹1,500
 - 4. ₹2,000

Q.13 What is the correct ascending order of the following ratios?

$$\frac{8}{15}, \frac{19}{20}, \frac{23}{60}, \frac{27}{35}$$

- Ans
- 1. $\frac{23}{60} < \frac{8}{15} < \frac{27}{35} < \frac{19}{20}$
 - 2. $\frac{23}{60} < \frac{27}{35} < \frac{8}{15} < \frac{19}{20}$
 - 3. $\frac{23}{60} < \frac{8}{15} < \frac{19}{20} < \frac{27}{35}$
 - 4. $\frac{8}{15} < \frac{23}{60} < \frac{27}{35} < \frac{19}{20}$

Q.14 How long (in years) will it take a sum of money invested at 8% per annum on simple interest to increase its value by 40%?

- Ans
- 1. 7
 - 2. 5
 - 3. 3
 - 4. 6

Q.15 If each side of an equilateral triangle is increased by 80%, then by what percentage will the area increase?

- Ans
- 1. 224%
 - 2. 120%
 - 3. 238%
 - 4. 240%

Section : Computer Proficiency

Q.1 Which internet protocol is responsible for assigning unique IP addresses to devices on a network and ensuring they can communicate with each other?

- Ans
- 1. DNS (Domain Name System)
 - 2. DHCP (Dynamic Host Configuration Protocol)
 - 3. HTTP (Hypertext Transfer Protocol)
 - 4. TCP (Transmission Control Protocol)

Q.2 Which of the following is the correct syntax to enter a Date in MS-Excel 365?

- Ans
- 1. =DATE(year,month,day)
 - 2. =DATE(month,day,year)
 - 3. =DATE(year,day,month)
 - 4. =DATE(day,year,month)

Q.3 Which of the following is NOT a component of an email message?

- Ans
- 1. Cc
 - 2. To
 - 3. Ncc
 - 4. Subject

Q.4 In Microsoft Word 365, in which layout mode can we see how text and graphics will appear on the printed page?

- Ans
- 1. Normal Layout
 - 2. Web Layout
 - 3. Print Layout
 - 4. Quick Layout

Q.5 If you are currently in Cell D4 in Microsoft Excel and you press the Enter key, to which cell will you move?

- Ans**
- 1. You will go to Cell D5
 - 2. You will go to Cell D3
 - 3. You will go to Cell C4
 - 4. You will go to Cell E4

Q.6 Which pair of keyboard shortcuts is used for copying and pasting words in MS word 365?

- Ans**
- 1. Ctrl + C and Ctrl + A
 - 2. Ctrl + C and Ctrl + S
 - 3. Ctrl + C and Ctrl + Z
 - 4. Ctrl + C and Ctrl + V

Q.7 Which of the following methods is used to open word Processing package?

- Ans**
- 1. Start->All Programs->Word Processor
 - 2. Start->All Programs->Microsoft Word
 - 3. File-> All Programs->Microsoft Word
 - 4. File-> All Programs->Word Processor

Q.8 What is the shortcut key for opening the documents in MS-Word 365?

- Ans**
- 1. Ctrl + O
 - 2. Ctrl + W
 - 3. Ctrl + V
 - 4. Ctrl + B

Q.9 In MS-Word 365, which feature allows you to track and review changes made to a document, such as additions, deletions, and formatting modifications?

- Ans**
- 1. AutoSave
 - 2. Track Changes
 - 3. Spelling and Grammar Check
 - 4. Version History

Q.10 Which of the following is an absolute cell reference in an MS Excel spreadsheet?

- Ans**
- 1. \$A1
 - 2. \$A\$1
 - 3. A\$1
 - 4. A1

Constable Executive Male and Female in Delhi Police Examination 2023

Exam Date	24/11/2023
Exam Time	12:00 PM - 1:30 PM
Subject	Constable Executive Male and Female in Delhi Police Examination 2023

Section : General Knowledge

Q.1 The Charter Act of _____ suspended the monopoly of the East India Company over trade with India.

- Ans**
- 1. 1833
 - 2. 1813
 - 3. 1973
 - 4. 1853

Q.2 Which of the following statement is related to Koeppen's 'A' type of climate?

- Ans**
- 1. Average temperature of the coldest month is 18°C or higher
 - 2. Possible evaporation is equal to precipitation
 - 3. Average temperature for all months is below 10°C
 - 4. Cold due to elevation

Q.3 When was the Jan Dhan Yojana launched?

- Ans**
- 1. 2014
 - 2. 2016
 - 3. 2015
 - 4. 2013

Q.4 Who among the following Muslim leaders of British India joined the All-India Muslim League in 1913?

- Ans**
- 1. Maulana Abul Kalam Azad
 - 2. Maulana Shaukat Ali
 - 3. Muhammad Ali Jinnah
 - 4. Hakim Ajmal Khan

Q.5 The lower portion of Dhamekh Stupa at Sarnath is covered with carved _____ .

- Ans**
- 1. wood
 - 2. stone
 - 3. granite
 - 4. marble

Q.6 Pandrethan temple of Srinagar is associated with which of the following religions?

- Ans**
- 1. Hinduism
 - 2. Sikhism
 - 3. Buddhism
 - 4. Jainism

Q.7 What is the full form of NADA?

- Ans
- 1. National Anti-Doping Agency
 - 2. National Assessment and Development Agency
 - 3. National Athletes-Development Agency
 - 4. National Age-Detecting Agency

Q.8 According to the 2011 Census, which state has the least population in India?

- Ans
- 1. Nagaland
 - 2. Sikkim
 - 3. Arunachal Pradesh
 - 4. Tripura

Q.9 Padmaja Reddy is a famous _____ classical dancer.

- Ans
- 1. Kuchipudi
 - 2. Bharatnatyam
 - 3. Kathak
 - 4. Kathakali

Q.10 Gorgonia ventalina is the scientific name of which saltwater invertebrate?

- Ans
- 1. Sea urchin
 - 2. Common sea fan
 - 3. Sea cucumber
 - 4. Sea anemone

Q.11 Who is considered as the highest law officer in the country?

- Ans
- 1. Attorney General of India
 - 2. Chief Election Commissioner
 - 3. Chairman of NITI AAYOG
 - 4. Chief Justice of India

Q.12 The structural part of the Indian Constitution is derived from:

- Ans
- 1. Government of India Act 1935
 - 2. Government of India Act 1919
 - 3. Government of India Act 1909
 - 4. Government of India Act 1958

Q.13 Who among the following kings founded a suburban township near Vijayanagara called Nagalapuram?

- Ans
- 1. Rajaraja Chola
 - 2. Rajendra I
 - 3. Krishnadevaraya
 - 4. Deva Raya II

Q.14 Consider the following statements and select the correct option.

A: All the objects must change from solids into liquids before changing into gases.

B: Evaporation is the process by which solids can change into gases.

- Ans
- 1. A is false, but B is true
 - 2. A is true, but B is false
 - 3. Both A and B are true
 - 4. Both A and B are false

Q.15 In the game of discus throw what is the standard weight of a discus for women?

- Ans**
- 1. 1500 gm
 - 2. 1200 gm
 - 3. 800 gm
 - 4. 1000 gm

Q.16 Identify the artist who is NOT associated with the musical instrument sarangi.

- Ans**
- 1. Pandit Ram Narayan
 - 2. Pandit Vishwa Mohan Bhat
 - 3. Ustad Binda Khan
 - 4. Shakoor Khan

Q.17 The term 'bouncer' is used in which of the following games?

- Ans**
- 1. Football
 - 2. Tennis
 - 3. Hockey
 - 4. Cricket

Q.18 In which of the following states of India is the Nokrek Biosphere Reserve located?

- Ans**
- 1. Nagaland
 - 2. Telangana
 - 3. Meghalaya
 - 4. Karnataka

Q.19 What is the primary factor contributing to structural unemployment in India?

- Ans**
- 1. Lack of education
 - 2. Seasonal variations
 - 3. Unavailability of jobs
 - 4. Technological advancements

Q.20 In which of the following years was the Railway budget merged with the Union budget?

- Ans**
- 1. 2019
 - 2. 2012
 - 3. 2017
 - 4. 2015

Q.21 Shovana Narayan an officer with the Indian Audit and Account Services, has won many awards for her contribution to the field of dance at the international level and has recently acted in a movie. She is an exponent of which of the following dance forms?

- Ans**
- 1. Odissi
 - 2. Bharatanatyam
 - 3. Kuchipudi
 - 4. Kathak

Q.22 Which of the following communities of Sikkim celebrates 'Sonam Lochar' as its New Year on the first day of the twelfth month in the lunar calendar?

- Ans**
- 1. Gurung
 - 2. Tamang
 - 3. Kirat Khambu Rai
 - 4. Lepcha

Q.23 Who of the following wrote 'Prithviraj Raso'?

- Ans
- 1. Jaidev
 - 2. Chand Bardai
 - 3. Padmagupta
 - 4. Rajasekhara

Q.24 Padma Shri awardee, Shivnath Mishra is an exponent of Benaras Gharana and he plays _____ styles of Benaras Gayaki Ang.

- Ans
- 1. Three
 - 2. Two
 - 3. Six
 - 4. Four

Q.25 The famous Hindu Temple 'Koneswaram' is located in which country?

- Ans
- 1. Nepal
 - 2. Sri Lanka
 - 3. Bhutan
 - 4. Pakistan

Q.26 According to the Ministry of Fisheries, Animal Husbandry and Dairying, Government of India, what was India's rank in milk production in the world in 2022?

- Ans
- 1. Fifth
 - 2. Second
 - 3. Third
 - 4. First

Q.27 The process of removing silica from soil is known as:

- Ans
- 1. salinisation
 - 2. leaching
 - 3. polarisation
 - 4. desilication

Q.28 My times: An autobiography, is authored by whom among the following famous freedom fighters of India?

- Ans
- 1. Motilal Nehru
 - 2. Vinoba Bhave
 - 3. J B Kriplani
 - 4. C R Das

Q.29 Ponnayya, Vadivelu, Shivanandam and Chinnayya who were renowned as Tanjore Bandhu, were well-known exponents of which dance?

- Ans
- 1. Kathakali
 - 2. Bharatnatyam
 - 3. Mohiniyattam
 - 4. Kuchipudi

Q.30 Which of the following committees was constituted in 1955 for village and small-scale industries?

- Ans
- 1. Hussain Committee
 - 2. Karve Committee
 - 3. Nayak Committee
 - 4. Kohli Committee

Q.31 In the states, No Demand for Grants can be made EXCEPT on the recommendation of the _____.

- Ans
- 1. President of India
 - 2. Governor
 - 3. Chief Minister
 - 4. Finance Minister of the State

Q.32 Which of the following is referred to as a relaxation of Government restrictions?

- Ans
- 1. Globalisation
 - 2. Disinvestment
 - 3. Privatisation
 - 4. Liberalisation

Q.33 'Maila Aanchal', one of the finest examples of regional novels is written by:

- Ans
- 1. Kamleshwar
 - 2. Phanishwar Nath Renu
 - 3. Munshi Premchand
 - 4. Kedar Nath Singh

Q.34 Which Article of the Constitution of India mentions that "it shall be the duty of every citizen of India to protect and improve the natural environment including forests, lakes, rivers and wild life, and to have compassion for living creatures"?

- Ans
- 1. 51A (e)
 - 2. 51A (j)
 - 3. 51A (b)
 - 4. 51A (g)

Q.35 In the Commonwealth Games, 2022, India won _____.

- Ans
- 1. 24 gold medals
 - 2. 25 gold medals
 - 3. 22 gold medals
 - 4. 23 gold medals

Q.36 Which of the following was co-founded by Subhas Chandra Bose?

- Ans
- 1. All India Forward Bloc
 - 2. All India Students Federation
 - 3. Kisan Majdoor Praja Party
 - 4. Congress Socialist Party

Q.37 Through which Constitution Amendment Act was Article 39A inserted into the Constitution of India?

- Ans
- 1. 48th Amendment Act
 - 2. 44th Amendment Act
 - 3. 46th Amendment Act
 - 4. 42nd Amendment Act

Q.38 Article 76 of the Constitution of India provides for:

- Ans
- 1. Ombudsman
 - 2. Finance Commission Chairman
 - 3. Election Commissioner
 - 4. Attorney General

Q.39 Banganga Festival, held every year in the city of Mumbai, is a musical tribute to_____.

- Ans
- 1. Lord Rama
 - 2. Lord Ganesh
 - 3. Lord Shiva
 - 4. Lord Brahma

Q.40 Which Article of the Constitution of India mentions that the State shall, in particular, direct its policy towards securing equal pay for equal work for both, men and women?

- Ans
- 1. Article 33
 - 2. Article 37
 - 3. Article 39
 - 4. Article 30

Q.41 In which of the following years did the Muslim League demand Pakistan, a separate nation for Indian Muslims?

- Ans
- 1. 1937
 - 2. 1943
 - 3. 1940
 - 4. 1932

Q.42 What was the capital of North-western province under Ashoka?

- Ans
- 1. Suvarnagiri
 - 2. Tosali
 - 3. Taxila
 - 4. Ujjayini

Q.43 During the British era India was an exporter of:

- Ans
- 1. Manufacturing products
 - 2. capital goods
 - 3. industrial products
 - 4. primary products

Q.44 The process by which the mix of species and habitat in an area changes over time is called:

- Ans
- 1. ecological balance
 - 2. ecological saturation
 - 3. ecological degradation
 - 4. ecological succession

Q.45 Identify the group of crops that are associated with Kharif season in the northern states of India?

- Ans
- 1. Cotton, Bajra, Maize, Wheat, Gram
 - 2. Rice, Cotton, Bajra, Rapeseeds, Mustard
 - 3. Rice, Cotton, Bajra, Maize, Jowar
 - 4. Wheat, Gram, Rapeseeds, Mustard, Barley

Q.46 Which dynasty's king was the first ruler to issue gold coins on a large scale in India?

- Ans
- 1. Unani
 - 2. Pahlava
 - 3. Shaka
 - 4. Kushan

Q.47 Identify the precipitate formed when carbon dioxide gas is passed through lime water.

- Ans**
- 1. Zinc carbonate
 - 2. Calcium carbonate
 - 3. Sodium oxide
 - 4. Calcium oxide

Q.48 Which of the following schemes come under the Ministry of Commerce and Industry?

- Ans**
- 1. National Bal Swachhta
 - 2. National Digital Health Mission
 - 3. Make in India
 - 4. Swachh Bharat Abhiyan

Q.49 Who is known as the 'Father of Microfinance'? He founded Grameen Bank to make small loans available to the poor.

- Ans**
- 1. Mahbub Haq
 - 2. Amartya Sen
 - 3. Muhammad Yunus
 - 4. Mahatma Gandhi

Q.50 Who among the following won the '66th Filmfare Award 2021 for Best Choreography' for the song Dil Bechara?

- Ans**
- 1. Prabhu Deva
 - 2. Farah Khan
 - 3. Remo D'Souza
 - 4. Ganesh Acharya

Section : Reasoning

Q.1 Which of the following terms will replace the question mark (?) in the given series?
CYFW, GUIT, KQLQ, ?, SIRK

- Ans**
- 1. PNON
 - 2. PMON
 - 3. OMON
 - 4. ONOM

Prepare 50% Faster

Q.2 Given below is a series of figures – A, B, C and D which follow a particular pattern. Which of the given option figure come in place of E to continue the series?

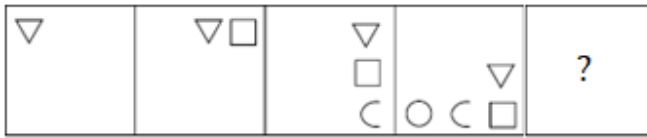

(A) (B) (C) (D) (E)

Ans

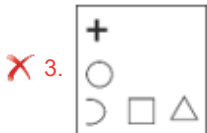
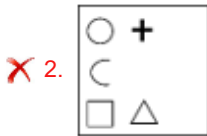
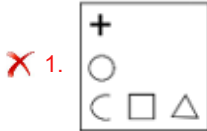

Q.3 Select the correct mirror image of the given figure when the mirror is placed at MN as shown below.



Ans



Q.4 Which two signs should be interchanged to make the given equation correct?

$$144 \div 12 + 12 - 12 \times 12 = 1$$

Ans

✓ 1. = and ×

✗ 2. × and -

✗ 3. ÷ and +

✗ 4. + and -

Q.5 Select the option in which the given figure is embedded (rotation is NOT allowed).

Ans

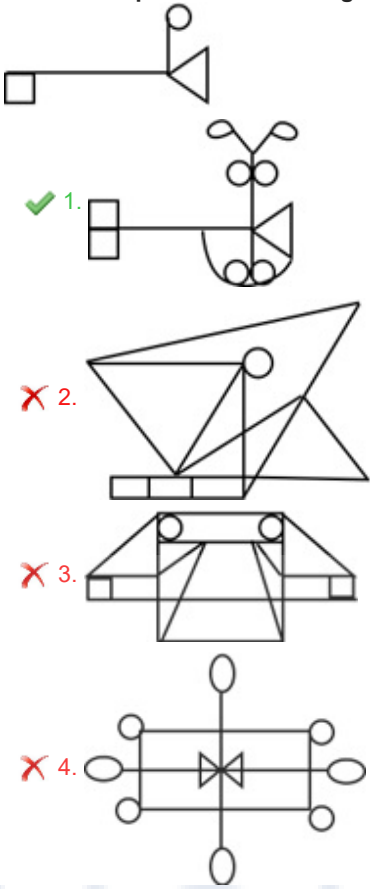

Prepare 50% Faster

Q.6 Which of the following option figures will complete the pattern in the figure given below?



Ans

X 1.



✓ 2.



X 3.



X 4.



Q.7 Which of the following option figures will complete the pattern in the figure given below?



Ans

- 1.
- 2.
- 3.
- 4.

Q.8 In a certain code language, 'CODY' is written as 'CQDA' and 'DINO' is written as 'DKNQ'. How will 'RAIN' be written in that language?

- Ans
- 1. RCPI
 - 2. RPIC
 - 3. PCIP
 - 4. RCIP

Q.9 Select the correct mirror image of the given figure when the mirror is placed at MN as shown below.

V L M c 3 8 S

M _____ N

- Ans
- 1. $\Lambda \Gamma W \cup 3 8 S$
 - 2. $\Lambda \Gamma W c \epsilon 8 2$
 - 3. $\Lambda \Gamma W c 3 8 2$
 - 4. $\Lambda J W c 3 8 2$

Q.10 Select the correct combination of mathematical signs that can sequentially replace the * signs and balance the given equation.
 $20 * 60 * 40 * 20 * 10 * 0$

- Ans
- 1. +, x, -, +, =
 - 2. +, x, -, =, +
 - 3. +, -, x, +, =
 - 4. +, -, x, +, =

Q.11 Two statements are given, followed by three conclusions numbered I, II and III. Assuming the statements to be true, even if they seem to be at variance with commonly known facts, decide which of the conclusions logically follow(s) from the statements.

Statements:

All shrubs are trees.

Some plants are shrubs.

Conclusions:

I. All plants are trees.

II. Some trees are shrubs.

III. No plant is a tree.

- Ans
- 1. Only conclusion II follows
 - 2. Only conclusion III follows
 - 3. Either conclusion I or III follows
 - 4. Only conclusions II and III follow

Q.12 Which of the following options will replace the question mark (?) in the given series?
 43, 301, 236, 1652, 1587, ?, 11044

- Ans
- 1. 709
 - 2. 1173
 - 3. 11109
 - 4. 963

Q.13 How many triangles are there in the figure given below?

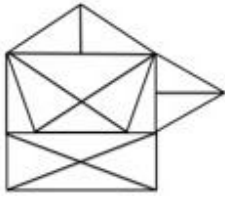

- Ans
- ✓ 1. 24
 - ✗ 2. 16
 - ✗ 3. 20
 - ✗ 4. 22

Q.14 Select the correct mirror image of the given figure when the mirror is placed at PQ as shown below.



- Ans
- ✓ 1. !R0L%LOR!&HGF%LOR!
 - ✗ 2. &R0A0%GH!HGF%LOR!
 - ✗ 3. !R0L%LOR!&HGF%LOR!
 - ✗ 4. !R0A0%GH&HGF%LOR!

Q.15 Select the figure that will replace the question mark (?) in the following figure series.



- Ans
- ✓ 1.
 - ✗ 2.
 - ✗ 3.
 - ✗ 4.

Q.16 Which figure should replace the question mark (?) in the following series to continue the pattern?

	□		8		↑		F					
8	☆	F	Z	5	□	F	8	V	□	A	↑	?
Z	V	↑	V	↑	F	□	5	Z	5	Z	V	

Ans

✗ 1.

	Z	
5	F	□
V	A	↑

✗ 2.

	5	
A	↑	Z
V	□	F

✓ 3.

	Z	
V	F	5
↑	A	□

✗ 4.

	A	
↑	Z	V
□	F	5

Q.17 Select the option that is related to the third term in the same way as the second term is related to the first term and the sixth term is related to the fifth term.

1278 : 1478 :: 1926 : ? :: 3798 : 3998

Ans ✗ 1. 1876

✗ 2. 2026

✓ 3. 2126

✗ 4. 1986

Prepare 50% Faster

Q.18 Select the figure from the options that can replace the question mark (?) and complete the given pattern.

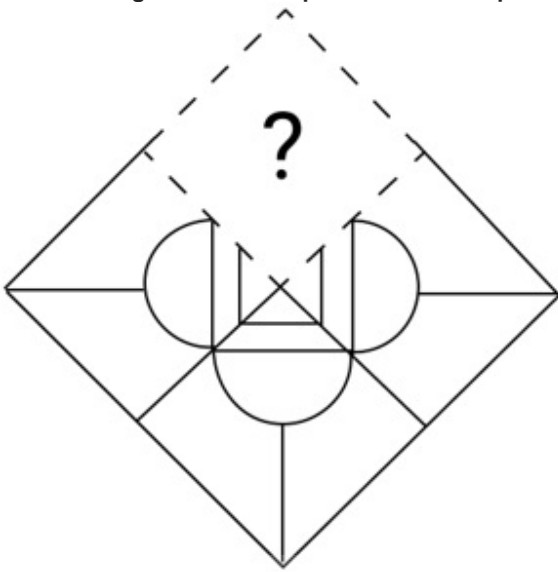

Ans

✗ 1.

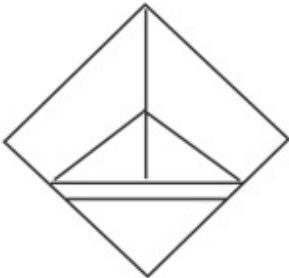

✗ 2.

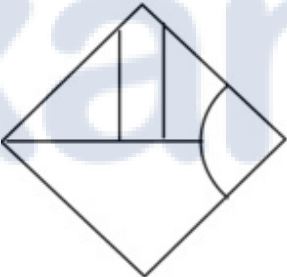

✗ 3.

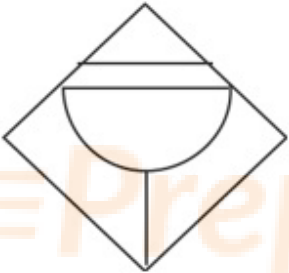

✓ 4.

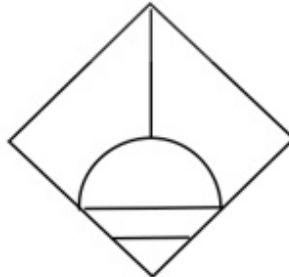

Q.19 Select the option figure which is embedded in the given figure. (Rotation is NOT a

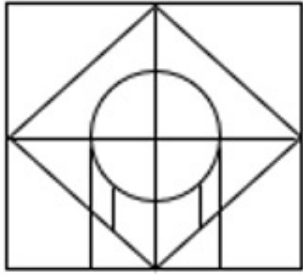

Ans

X 1.



✓ 2.



X 3.

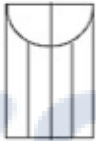

X 4.



Q.20 O, P, Q, R, W and X are sitting around a circular table facing the centre. W sits second to the left of R. Q sits to the immediate left of W. O sits to the immediate left of X. Who sits to the immediate left of R?

Ans X 1. O

✓ 2. P

X 3. X

X 4. Q

Q.21 Select the option that is related to the fifth letter-cluster in the same way as the second letter-cluster is related to the first letter-cluster and the fourth letter-cluster is related to the third letter-cluster.
EDGE : CEBC :: ICON : LMAG :: KICK : ?

Ans ✓ 1. IAGI

X 2. JAGJ

X 3. IAGJ

X 4. IAHI

Q.22 Select the correct mirror image of the given combination when the mirror is placed at 'MN' as below.

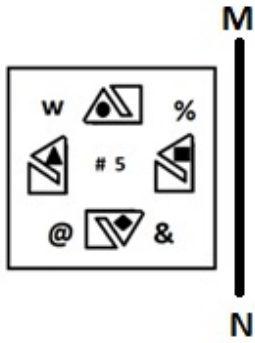

Problem figure:

Ans

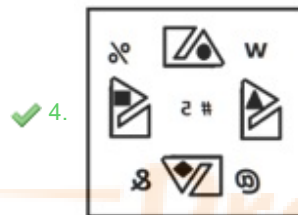
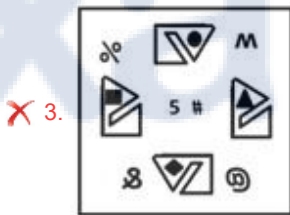
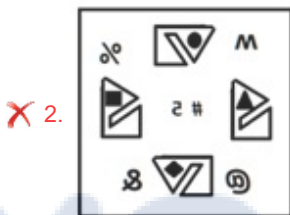
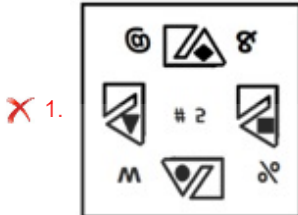

Q.23 Select the set in which the numbers are related in the same way as are the numbers of the given sets.
(NOTE: Operations should be performed on the whole numbers, without breaking down the numbers into its constituent digits. E.g., 13 – Operations on 13 such as adding/ deleting/ multiplying etc. to 13 can be performed. Breaking down 13 into 1 and 3 and then performing mathematical operations on 1 and 3 is not allowed.)
(101, 106, 111)
(214, 198, 182)

- Ans
- ✗ 1. (89, 95, 99)
 - ✗ 2. (78, 136, 190)
 - ✓ 3. (163, 156, 149)
 - ✗ 4. (123, 129, 133)

Q.24 Select the correct mirror image of the given combination when the mirror is placed at 'XY' as shown below.

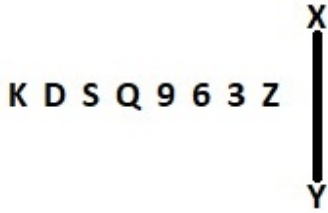

- Ans
- ✓ 1. Z 3 6 9 Q S D K
 - ✗ 2. Z 3 e a σ 2 D K
 - ✗ 3. K D 2 σ a e 3 Z
 - ✗ 4. Z 3 6 9 Q S D K

Q.25 A square sheet of paper is folded along the dotted line successively along the directions shown and is then punched in the last. How would the paper look when unfolded?



- Ans
- ✗ 1.
 - ✓ 2.
 - ✗ 3.
 - ✗ 4.

Q.1 The radius of the base and height of a solid right circular cylinder are in the ratio 7:3 and its volume is 12474 cm^3 . What is the total surface area of the cylinder?
(Use $\pi = \frac{22}{7}$)

- Ans
- 1. 2960 cm^2
 - 2. 1760 cm^2
 - 3. 2160 cm^2
 - 4. 3960 cm^2

Q.2 Four years ago, the population of a city was 10,000. The annual growth rate of the population during the first two years was 20%. In the third and fourth years, there was a decrease in the population at the rate of 10% and 5%, respectively. What is the current population of the city after four years?

- Ans
- 1. 12312
 - 2. 10500
 - 3. 16632
 - 4. 14288

Q.3 Lalita bought 10 water bottles for ₹18 each and sold them for ₹20 each. What is her overall profit percentage?

- Ans
- 1. 13%
 - 2. 11%
 - 3. $11\frac{1}{9}\%$
 - 4. $13\frac{2}{9}\%$

Q.4 Which of the ratio is the smallest?

$$\frac{4}{5}, \frac{12}{14}, \frac{21}{23}, \frac{16}{19}, \frac{79}{85} = ?$$

- Ans
- 1. $\frac{12}{14}$
 - 2. $\frac{4}{5}$
 - 3. $\frac{79}{85}$
 - 4. $\frac{16}{19}$

Q.5 An amount of ₹4,000 was divided into two parts in such a way that, when the first part was invested at 3% per annum simple interest and the second at 5% per annum simple interest, the total annual interest from both the investments was ₹144. How much was put at 3% per annum simple interest?

- Ans
- 1. ₹2,100
 - 2. ₹1,400
 - 3. ₹700
 - 4. ₹2,800

Q.6 The smallest four-digit number which is divisible by 15, 25, 40 and 75 is:

- Ans
- 1. 1080
 - 2. 1100
 - 3. 1120
 - 4. 1200

Q.7 8 men can complete a work in 6 hours. In how many hours can 12 men complete the same work?

- Ans
- 1. 4
 - 2. 6
 - 3. 5
 - 4. 3

Q.8 The price of an article is reduced by 25% and its daily sale is increased by 30%. The net effect on the daily sale receipts is:

- Ans
- 1. $2\frac{1}{2}\%$ decrease
 - 2. $2\frac{1}{2}\%$ increase
 - 3. 3% increase
 - 4. 3% decrease

Q.9 What is the difference between the total surface area and the curved surface area of a hemisphere (in cm^2) when the radius is 21 cm? (Take $\pi = \frac{22}{7}$)

- Ans
- 1. 1386
 - 2. 1376
 - 3. 1586
 - 4. 1495

Q.10 The market price of a toy is 25% above the cost price. If the shopkeeper gives 12% discount, then find the gain in the deal.

- Ans
- 1. 12%
 - 2. 13%
 - 3. 10%
 - 4. 15%

Q.11 If a person walked 14 km/h instead of 10 km/h, he would have walked 20 km more. The actual distance travelled by him is:

- Ans
- 1. 150 km
 - 2. 70 km
 - 3. 50 km
 - 4. 100 km

Q.12 Ram received an annual salary of ₹48,580 in the year 2008. This was 25% more than his salary in 2007. What was his salary in 2007?

- Ans
- 1. ₹39,670
 - 2. ₹38,864
 - 3. ₹31,750
 - 4. ₹33,864

Q.13 What is the difference between the smallest and the largest prime numbers between 1 to 100?

- Ans
- 1. 87
 - 2. 94
 - 3. 95
 - 4. 86

Q.14 Find the average of 72, 81, 90, 68, 61.

- Ans
- 1. 72.2
 - 2. 76.8
 - 3. 78.6
 - 4. 74.4

Q.15 What is the result of the expression $4.5 \times 2.8 + 3.6 \times 2.5 - 1.7 \times 12$?
(Use decimal upto 1 point)

- Ans
- 1. 1.9
 - 2. 1.2
 - 3. 2.3
 - 4. 3.4

Section : Computer Proficiency

Q.1 Which of the following shortcut keys is used to perform right alignment in MS Word 365?

- Ans
- 1. Ctrl + L
 - 2. Ctrl + R
 - 3. Ctrl + Shift + >
 - 4. Ctrl + Shift + <

Q.2 In MS word 365. Which of the following menus has icons to Add Text, Update A Table, Insert Footnote, and Index in the Word Processing Package?

- Ans
- 1. Design
 - 2. Page Layout
 - 3. References
 - 4. Mailings

Q.3 Which of the following in communication of internet is a process of transferring real-time messages between users that facilitates private chat room atmosphere?

- Ans
- 1. Collaboration
 - 2. Instant messaging
 - 3. Remote access
 - 4. File sharing

Q.4 In MS Excel 365, how can a full name in MS-Excel 365 be split into separate first name and last name columns?

- Ans
- 1. Using the CONCATENATE function
 - 2. Using the Data Validation feature
 - 3. Using the Text to Columns feature
 - 4. Using the TEXT function

Q.5 In Microsoft Word 365, what does paragraph formatting primarily control?

- Ans
- 1. Font style and colour
 - 2. Document headers and footers
 - 3. Page layout and margins
 - 4. Line spacing and alignment

Q.6 In MS Excel 365 , which of the following keyboard shortcuts will open the 'Open' dialog box, where you can navigate to the location of a spreadsheet file and open it?

- Ans**
- 1. Ctrl + Shift + O
 - 2. Alt + O
 - 3. Shift + Alt + O
 - 4. Ctrl + O

Q.7 Which of the following is an email client offered by Microsoft?

- Ans**
- 1. Outlook
 - 2. Gmail
 - 3. Thunderbird
 - 4. Apple

Q.8 Which of the following signs is always the first part of the formula followed by an expression that calculates a value in MS-Excel 365?

- Ans**
- 1. = (Equal to)
 - 2. - (Subtraction)
 - 3. / (Division)
 - 4. + (Addition)

Q.9 Which button in the Home tab of Microsoft Word 365 can be used to cut selected text?

- Ans**
- 1. Scissors icon
 - 2. Clipboard icon
 - 3. Double sheets of paper icon
 - 4. Arrow pointing down icon

Q.10 How can we combine names and addresses with a standard document in Microsoft Word 365?

- Ans**
- 1. Mail Formatting
 - 2. Mail Merge
 - 3. Document Formatting
 - 4. Document Merge

Prepare 50% Faster

Constable Executive Male and Female in Delhi Police Examination 2023

Exam Date	24/11/2023
Exam Time	3:00 PM - 4:30 PM
Subject	Constable Executive Male and Female in Delhi Police Examination 2023

Section : General Knowledge

Q.1 Who was known as the 'Frontier Gandhi of India' and was the leader of North West Frontier province of British India?

- Ans**
- 1. Khan Abdul Gaffar Khan
 - 2. Subhash Chandra Bose
 - 3. Mahatma Gandhi
 - 4. Jawaharlal Nehru

Q.2 'A shot at History' is an autobiography of whom among the following Olympic medal awardees?

- Ans**
- 1. PV Sindhu
 - 2. Sushil Kumar
 - 3. Abhinav Bindra
 - 4. Leander Paes

Q.3 Gangwon is the host city of which of the following sports events?

- Ans**
- 1. Winter Olympics 2024
 - 2. Summer Youth Olympic Games 2024
 - 3. Winter Youth Olympic Games 2024
 - 4. Summer Olympics 2024

Q.4 The Directive Principle of State Policy that requires the State 'to minimise inequalities in income, status, facilities and opportunities' was added by the _____ Constitution Amendment Act.

- Ans**
- 1. 44th
 - 2. 40th
 - 3. 41st
 - 4. 43rd

Q.5 As per Article 170 of the Constitution of India, the Legislative Assembly of each State shall consist of NOT more than _____ members.

- Ans**
- 1. 450
 - 2. 300
 - 3. 500
 - 4. 250

Q.6 In which year did Anil Kumble take 10 wickets in a cricket test match?

- Ans**
- 1. 1999
 - 2. 1987
 - 3. 1986
 - 4. 1998

Q.7 Which of the following is NOT a major jute producing state in India?

- Ans**
- 1. Meghalaya
 - 2. West Bengal
 - 3. Assam
 - 4. Telangana

Q.8 PMJJBY (Pradhan Mantri Jeevan Jyoti Bima Yojana) scheme is a type of ___.

- Ans**
- 1. life insurance scheme
 - 2. pension scheme
 - 3. AD&D scheme
 - 4. loan scheme

Q.9 Which of the following rivers passes through the maximum number of states in India?

- Ans**
- 1. Damodar
 - 2. Indus
 - 3. Ganga
 - 4. Mahanadi

Q.10 Lost wax casting technique was used to make _____ statues during Harappan civilisation.

- Ans**
- 1. wood
 - 2. rock
 - 3. bronze
 - 4. marble

Q.11 Which of the following is not correct about Article 19 of the Indian Constitution?

- Ans**
- 1. All citizens shall have the right to freedom of speech and expression.
 - 2. All citizens shall have the right to move freely outside the territory of India.
 - 3. All citizens shall have the right to assemble peaceably and without arms.
 - 4. All citizens shall have the right to form associations or unions.

Q.12 Which of the following books was written by Kautilya, Prime Minister of Chandragupta Maurya?

- Ans**
- 1. Arthashastra
 - 2. Anguttara Nikaya
 - 3. Bhagavati Sutra
 - 4. Purva Mimamsa Sutras

Q.13 Whose name among the following is associated with the second five-year plan?

- Ans**
- 1. Kantilal Mardia
 - 2. Jayanta Kumar Ghosh
 - 3. Debabrata Basu
 - 4. Prasanta Chandra Mahalanobis

Q.14 According to the National Jute Board 2022-23, which state is the largest producer of jute?

- Ans**
- 1. West Bengal
 - 2. Madhya Pradesh
 - 3. Bihar
 - 4. Gujarat

Q.15 Which of the following pairs is INCORRECT?

- Ans**
- 1. Part I – The Union and its Territory
 - 2. Part III – Fundamental Rights
 - 3. Part II – Fundamental Duties
 - 4. Part VIII – The Union Territories

Q.16 Who appoints the Attorney-General of India?

- Ans**
- 1. Prime Minister
 - 2. President
 - 3. Governor
 - 4. Chief Minister

Q.17 The stratosphere is located between which of the following atmospheric layers?

- Ans**
- 1. Mesosphere and Thermosphere
 - 2. Tropopause and Stratopause
 - 3. Stratopause and Mesopause
 - 4. Mesopause and Exosphere

Q.18 Which of the following awards is given in the field of dance by the government of Madhya Pradesh?

- Ans**
- 1. Kalidas Samman
 - 2. Tagore Ratna
 - 3. Sanatan Sangeet Sanskriti
 - 4. Nandi Award for Best Choreographer

Q.19 Which of the following is/are correct about curd formation?

Statement 1.

The bacteria present in milk breakdown lactose into lactic acid.

Statement 2.

Production of lactic acid reduces the pH of the milk, coagulating it to form curd.

Statement 3.

Curd and yoghurt are the synonyms and their texture and taste is exactly same.

- Ans**
- 1. Only statements 1 and 2 are correct
 - 2. Only statement 3 is correct
 - 3. Only statement 1 is correct
 - 4. All statements 1, 2 and 3 are correct

Q.20 In which city of Maharashtra is Kalidasa Festival organised every year?

- Ans**
- 1. Mumbai
 - 2. Nasik
 - 3. Nagpur
 - 4. Pune

Q.21 According to Census of India 2011, in how many States / Union Territories was the female literacy rate recorded more than 90%?

- Ans**
- 1. Four
 - 2. Two
 - 3. One
 - 4. Three

Q.22 Which of the following is a negative impact of globalisation on Indian economy?

- Ans
- 1. Rise in female participation in employment
 - 2. Loss of child labour
 - 3. Rise of straight-jacketed approach to leadership styles
 - 4. Rise in relative deprivation

Q.23 In India, poverty estimations are based on surveys conducted by the National Sample Survey Organisation (NSSO). Under which ministry does the NSSO function?

- Ans
- 1. Ministry of Labour and Employment
 - 2. Ministry of Finance
 - 3. Ministry of Consumer Affairs
 - 4. Ministry of Statistics and Programme Implementation

Q.24 The garbhagriha and shikhara are made in a Rekha-Prasada or Latina style and the mandapa of an old form of wooden architecture. These features of temple architecture are present in which part of India?

- Ans
- 1. Southern
 - 2. Western
 - 3. Eastern
 - 4. Northern

Q.25 Who among the following is associated with Kathakali?

- Ans
- 1. Kalamandalam Krishnan Nair
 - 2. Swapana Sundari
 - 3. Sujata Mohapatra
 - 4. Kaushalya Reddy

Q.26 Who led the Young Bengal Movement?

- Ans
- 1. Henry Vivian Derozio
 - 2. Raja Ram Mohan Roy
 - 3. Keshav Chandra Sen
 - 4. Devendra Nath Tagore

Q.27 Contingency Fund of India is operated by the _____.

- Ans
- 1. Reserve Bank's action
 - 2. Parliamentary action
 - 3. Judicial action
 - 4. Executive action

Q.28 Dollu Kunitha, a high energy popular folk dance of Karnataka region is primarily performed for which of the following deities?

- Ans
- 1. Lord Krishna
 - 2. Lord Shiva
 - 3. Lord Rama
 - 4. Lord Vishnu

Q.29 The density of population in India (Census 2011) is _____ persons per sq km.

- Ans
- 1. 296
 - 2. 357
 - 3. 284
 - 4. 382

Q.30 The official mascot of the Commonwealth Games 2022 was _____ .

- Ans
- 1. Miraitova
 - 2. La'eeb
 - 3. Bing Dwen
 - 4. Perry

Q.31 The term 'Protozoa' was coined by _____ .

- Ans
- 1. Goldfuss
 - 2. Lamarck
 - 3. Charles Darwin
 - 4. Robert Grant

Q.32 Gold Monetisation Scheme (GMS) was launched by the Government of India in _____. Under this scheme, one can deposit their gold in any form in a GMS account to earn interest as the price of the gold metal goes up.

- Ans
- 1. 2005
 - 2. 2010
 - 3. 2020
 - 4. 2015

Q.33 Which of the following equations correctly measures national income by expenditure method?

- Ans
- 1. $Y = C + I + G + X - M$
 - 2. $Y = C + I + G + X + M$
 - 3. $Y = C - I + G + X - M$
 - 4. $Y = C + I + G - X + M$

Q.34 Which of the following statements is true with regard to the establishment of Central Public Sector Undertakings in India?

- Ans
- 1. They are only expected to generate greater profits to fund the Indian budget.
 - 2. They are supposed to reduce the importance of the private sector in India.
 - 3. They are established to fulfil the objective of a self-reliant India.
 - 4. They are established solely for export-oriented industrialisation.

Q.35 Who was the Viceroy of India when the Indian National Congress was founded?

- Ans
- 1. Lord Dufferin
 - 2. Lord Elgin II
 - 3. Lord Ripon
 - 4. Lord Lansdowne

Q.36 Bacteria are the sole members of which of the following kingdoms?

- Ans
- 1. Monera
 - 2. Animalia
 - 3. Plantae
 - 4. Protista

Q.37 In which of following Yajnas was a horse let loose to wander freely and guarded by the raja's men in ancient India?

- Ans
- 1. Ashvadhari Yajna
 - 2. Brahma Yajna
 - 3. Naramedha Yajna
 - 4. Ashvamedha Yajna

Q.38 Which is the following is abolished, and its practice forbidden in any form, according to Article 17 of the Constitu

- Ans**
- 1. Untouchability
 - 2. Freedom of speech
 - 3. Discrimination
 - 4. Exploitation

Q.39 Name the popular dance of North-West India in which dancers balance multiple pots or pitchers on their head while standing on top of glass bottles or on the rim of a brass plate.

- Ans**
- 1. Tera Tali
 - 2. Garba
 - 3. Ghoomar
 - 4. Bhavai

Q.40 'Permanent Settlement' in Bengal was started by which of the following Governor-Generals?

- Ans**
- 1. Lord Cornwallis
 - 2. Thomas Munro
 - 3. Lord Minto
 - 4. Alexander Reed

Q.41 Identify the artist who popularised the guitar as an instrument in Indian classical music.

- Ans**
- 1. Sandeep Das
 - 2. N Ramani
 - 3. Brij Bhushan Kabra
 - 4. EM Subramaniam

Q.42 Famous Scholar Al-Biruni wrote Kitab-ul-Hind in _____ language.

- Ans**
- 1. Persian
 - 2. Arabic
 - 3. Sanskrit
 - 4. Urdu

Q.43 The process of depositing a layer of any desired metal on another material by means of electricity is called _____.

- Ans**
- 1. electrolysis
 - 2. photocatalysis
 - 3. electroplating
 - 4. photoelectrochemical

Q.44 Which Indian cricketer has written the book 'The Test of My Life'?

- Ans**
- 1. Yuvraj Singh
 - 2. Kapil Dev
 - 3. Sachin Tendulkar
 - 4. MS Dhoni

Q.45 Neeraj Chopra became the first Indian to win the prestigious _____ Final in Switzerland in 2022.

- Ans**
- 1. World Athletics Championships
 - 2. National Open Athletics Championships
 - 3. European Athletics Championships
 - 4. Zurich Diamond League

Q.46 The correct order of percentage of gases in atmosphere is:

- Ans
- 1. $N_2 > Ar > O_2 > CO_2$
 - 2. $N_2 > O_2 > CO_2 > Ar$
 - 3. $O_2 > N_2 > Ar > CO_2$
 - 4. $N_2 > O_2 > Ar > CO_2$

Q.47 Who among the following discovered the ruins of Hampi in 1800?

- Ans
- 1. Colonel Colin Mackenzie
 - 2. Colin Fitzroy
 - 3. Robert Mackenzie
 - 4. Robert Fitzroy

Q.48 2009 में ए.आर. रहमान ने दी गई श्रेणियों में से किस जोड़ी में ऑस्कर जीता?

- Ans
- 1. सर्वश्रेष्ठ मूल स्कोर और सर्वश्रेष्ठ मूल गीत
 - 2. सर्वश्रेष्ठ ध्वनि मिश्रण और सर्वश्रेष्ठ मूल गीत
 - 3. सर्वश्रेष्ठ मूल स्कोर और सर्वश्रेष्ठ ध्वनि मिश्रण
 - 4. सर्वश्रेष्ठ मूल संगीत और सर्वश्रेष्ठ ध्वनि मिश्रण

Q.49 Consider the given the values and answer the question that follows.

GNP at market prices = ₹15,50,113 crore
Indirect taxes = ₹1,75,386 crore
Subsidies = ₹38,504
Net factor income from abroad = (-) ₹13,439
What will be the value of GDP at factor cost?

- Ans
- 1. ₹17,00,434
 - 2. ₹14,13,231
 - 3. ₹14,26,670
 - 4. ₹13,99,792

Q.50 Select the INCORRECT pair of festival and the respective state.

- Ans
- 1. Sarhul – Tamil Nadu
 - 2. Chhath Puja – Bihar
 - 3. Dang Darbar – Gujarat
 - 4. Maghi – Himachal Pradesh

Section : Reasoning

Q.1 In a certain code language, 'WONDER' is written as 'KLTWCI' and 'SPRING' is written as 'OKPRTT'. How will 'PLAYER' be written as in that language?

- Ans
- 1. RBOICG
 - 2. RTLUX
 - 3. RPLSWZ
 - 4. ROGBCI

Q.2 Which of the following options will replace the question mark (?) in the given series?
512, 490, 468, 446, 424, ?

- Ans
- 1. 396
 - 2. 402
 - 3. 400
 - 4. 399

Q.3 Select the option figure that is embedded in the given figure. (Rotation is not allowed).

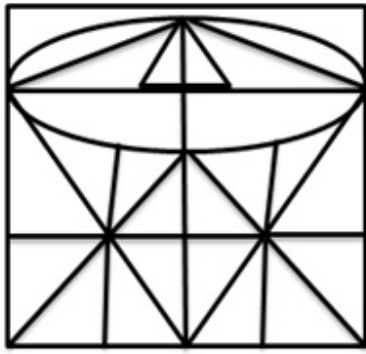

Ans

- ✓ 1.
- ✗ 2.
- ✗ 3.
- ✗ 4.

Q.4 Select the correct mirror image of the given combination when the mirror is placed at 'PQ' as shown below.



Ans

- ✗ 1. Q W 7 K J P
- ✓ 2. Q W 7 K J P
- ✗ 3. Q W 7 K J P
- ✗ 4. Q W 7 K J P

Q.5 Six numbers, 1, 2, 3, 4, 5 and 6, are written on the different faces of a dice. Three different positions of the same dice are shown (Figures 1-3). Find the number on the face opposite to the face showing '2'.

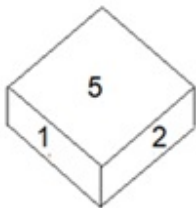

Figure 1

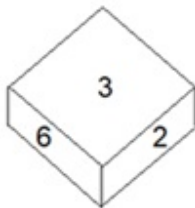

Figure 2

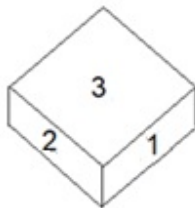

Figure 3

Ans

- ✓ 1. 4
- ✗ 2. 1
- ✗ 3. 6
- ✗ 4. 3

Q.6 Which figure should replace the question mark (?) in the following series to continue the pattern?

O	D	O	A	
D	O	A	O	?
9 = A	A 9 =	= 2 D	D = 2	

Ans

✗ 1.

O
D
= 2 A

✗ 2.

=
A
2 O D

✓ 3.

O
D
2 + A

✗ 4.

A
D
2 + O

Q.7 Which of the following option figures will complete the pattern in the figure given below?



Ans



Prepare 50% Faster

Q.8 Select the option in which the given figure is embedded (rotation is NOT allowed).



Ans

✓ 1.

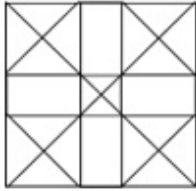

✗ 2.

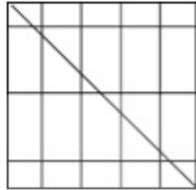

✗ 3.

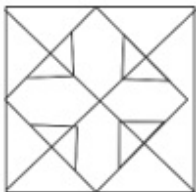

✗ 4.

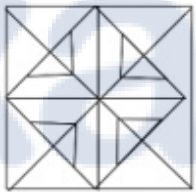

Q.9 1, 2, 3, 4, 5 and 6 are written on different faces of a dice. Three different positions of the same dice are shown below. Find the number on the face opposite to the one showing '6'.

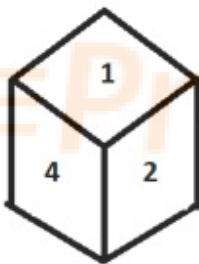

figure 1

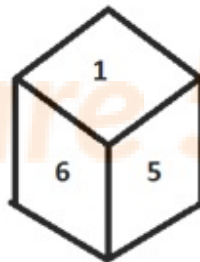

figure 2

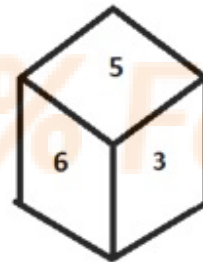

figure 3

Ans ✓ 1. 4

✗ 2. 2

✗ 3. 1

✗ 4. 5

Q.10 Seven people - A, B, C, D, E, F and G - are sitting in a straight row, facing north. Only two people sit to the left of B. Only three people sit between G and B. D sits second to the right of A. D is not an immediate neighbour of B. E sits to the immediate right of F. Who among the following sits at the extreme left end of the line?

Ans ✗ 1. G

✓ 2. F

✗ 3. A

✗ 4. C

Q.11 Select the figure from the given options that will replace the question mark (?) in the figure given below to complete the pattern so that the final image is symmetrical.

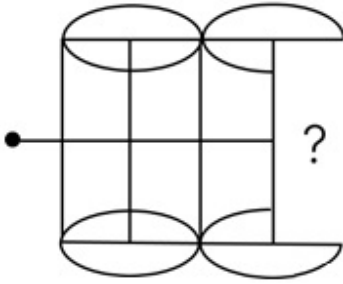

Ans

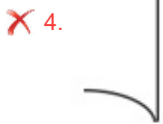
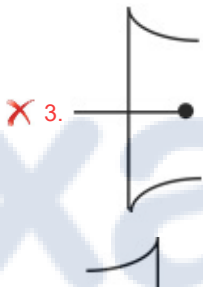
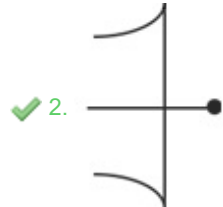
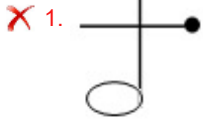

Prepare 50% Faster

Q.12 Select the figure from the options that can replace the question mark (?) and complete the given pattern.

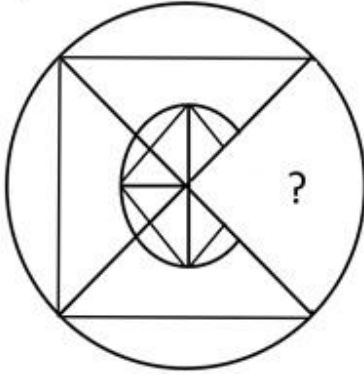

Ans

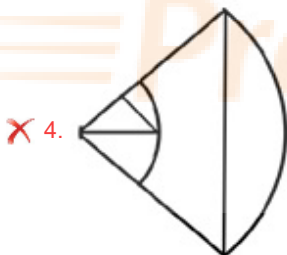
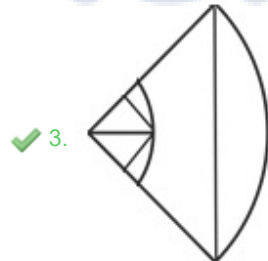
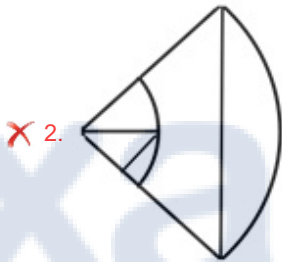
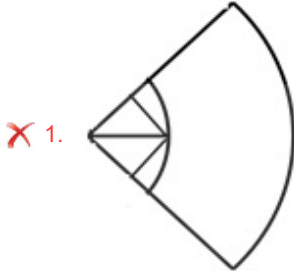

Q.13 Select the figure that will replace the question mark (?) in the following figure series.

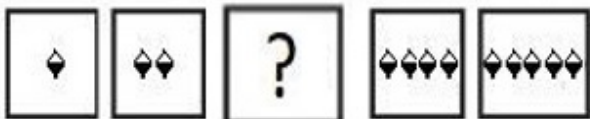

Ans

- 1.
- 2.
- 3.
- 4.

Q.14 Two statements are given followed by two conclusions numbered I and II. Assuming the statements to be true, even if they seem to be at variance with commonly known facts, decide which of the conclusions logically follow(s) from the statements.

Statements:

All potatoes are vegetables.

All carrots are vegetables.

Conclusions:

I. Some carrots are potatoes.

II. All vegetables are carrots.

- Ans
- 1. Only conclusion I follows
 - 2. Neither conclusion I nor II follows
 - 3. Only conclusion II follows
 - 4. Both conclusions I and II follow

Q.15 How many triangles are there in the given figure?

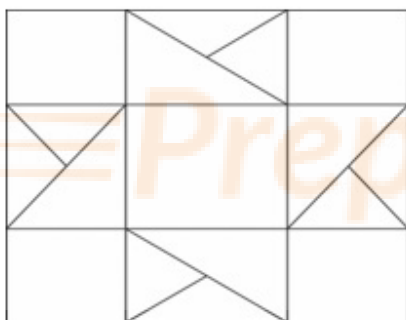

- Ans
- 1. 12
 - 2. 8
 - 3. 16
 - 4. 10

Q.16 Select the set in which the numbers are related in the same way as are the numbers of the following sets.
(NOTE : Operations should be performed on the whole numbers, without breaking down the numbers into its constituent digits. E.g. 13 – Operations on 13 such as adding /deleting /multiplying etc. to 13 can be performed. Breaking down 13 into 1 and 3 and then performing mathematical operations on 1 and 3 is NOT allowed)
(184, 23), (264, 33)

- Ans
- 1. (270, 39)
 - 2. (250, 36)
 - 3. (341, 41)
 - 4. (376, 47)

Q.17 The sequence of folding a piece of paper and the manner in which the folded paper has been cut is shown below figure which would most closely resemble the unfolded form of the paper.

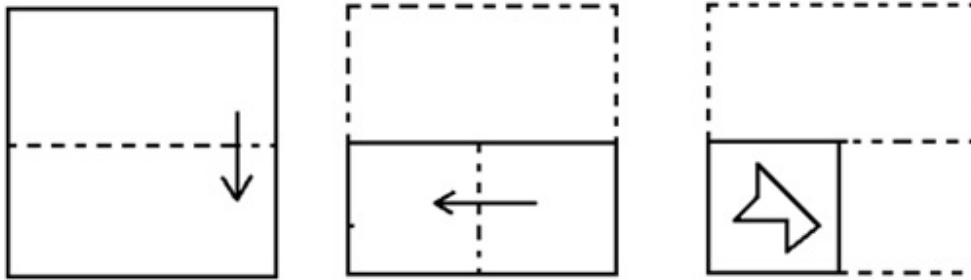

Ans

✗ 1.

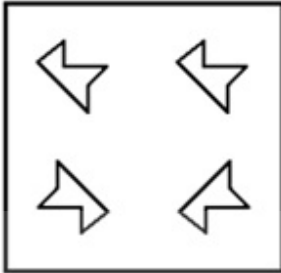

✗ 2.

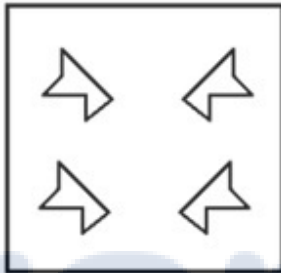

✗ 3.

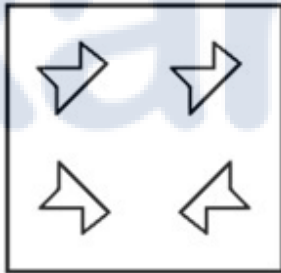

✓ 4.

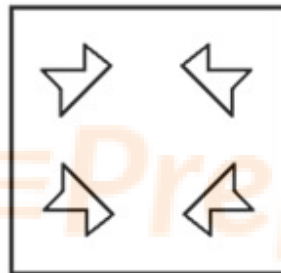

Q.18 Select the correct combination of mathematical signs to sequentially replace the * signs and to balance the given equation.
 $60 * 40 * 10 * 50 * 100 * 160$

Ans ✗ 1. $\div, \times, -, +, =$

✓ 2. $+, \div, \times, -, =$

✗ 3. $-, \div, \times, +, =$

✗ 4. $\times, \div, -, +, =$

Q.19 Select the option that is related to the fifth letter cluster in the same way as the second letter cluster is related to the first letter cluster and the fourth letter cluster is related to the third letter cluster.
KFCZ : HLZF :: LVEG : IBBM :: PROD : ?

Ans ✓ 1. MXLJ

✗ 2. IBNX

✗ 3. MKXJ

✗ 4. IHX

Q.20 Select the option figure that will replace the question mark (?) in the figure given below to complete the pattern.

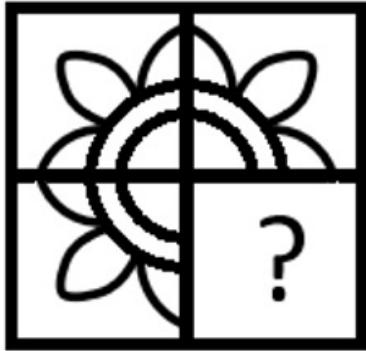

Ans

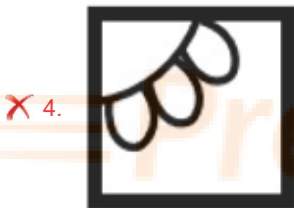

Q.21 Select the correct combination of mathematical signs to sequentially replace the * signs and to balance the given equation.
 $36 * 16 * 4 * 20 * 90 * 46$

- Ans
- ✓ 1. -, ÷, ×, +, =
 - ✗ 2. +, ÷, ×, -, =
 - ✗ 3. -, ÷, +, ×, =
 - ✗ 4. ×, ÷, +, -, =

Q.22 A paper is folded and cut as shown below. How will it appear when unfolded?



Ans

✓ 1.



✗ 2.

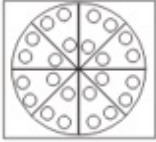

✗ 3.



✗ 4.



Q.23 Select the option that is related to the third term in the same way as the second term is related to the first term and the sixth term is related to the fifth term.
 $15 : 135 :: 13 : ? :: 24 : 216$

Ans

✗ 1. 104

✓ 2. 117

✗ 3. 91

✗ 4. 121

Prepare 50% Faster

Q.24 Which figure should replace the question mark (?) if the following series were to be continued?

P	O	T	D	8	P	T	D	S	Z	8	T	S	Z	△	?
	△			O			P			D			T		
S	8	4	T	△	S	△	8	O	S	P	△	P	8	D	

Ans

✓ 1.

F	8	S
	Z	
△	T	P

✗ 2.

P	8	S
	Z	
D	T	△

✗ 3.

D	8	S
	Z	
△	T	P

✗ 4.

P	S	D
	△	
8	Z	T

Q.25 Which of the following letter clusters will replace the question mark (?) in the given series to make it logically complete?
GMU, IKW, KIY, MGA, ?

- Ans
- ✓ 1. OEC
 - ✗ 2. OCI
 - ✗ 3. OIC
 - ✗ 4. OEB

Section : Numerical Ability

Q.1 $0.\overline{63}$ expressed in the form $\frac{p}{q}$ equals:

- Ans
- ✗ 1. $\frac{6}{11}$
 - ✓ 2. $\frac{7}{11}$
 - ✗ 3. $\frac{3}{11}$
 - ✗ 4. $\frac{9}{11}$

Q.2 Let $x = \frac{6}{5}$, then arrange the numbers $6x, \frac{37}{6}, 6 - x$ and $5 + x$ in ascending order.

- Ans
- 1. $6 - x, 5 + x, 6x, \frac{37}{6}$
 - 2. $6 - x, 5 + x, \frac{37}{6}, 6x$
 - 3. $6 - x, \frac{37}{6}, 5 + x, 6x$
 - 4. $6 - x, \frac{37}{6}, 6x, 5 + x$

Q.3 The vertical height of a conical tent is 42 decimetre and the diameter of its base is 5.4 m. Find the number of persons it can accommodate if each person is to be allowed 2,673 cu. decimetre of space. (Use $\pi = \frac{22}{7}$)

- Ans
- 1. 12
 - 2. 17
 - 3. 13
 - 4. 11

Q.4 The average of 24, 39 and y is 33. What is the value of y ?

- Ans
- 1. 35
 - 2. 36
 - 3. 38
 - 4. 37

Q.5 Ramu takes 1 hour 20 minutes in walking a distance and riding back to the starting place. He could walk both ways in 2 hours 30 minutes. The time taken by him to ride back both ways is:

- Ans
- 1. 22 minutes
 - 2. 20 minutes
 - 3. 18 minutes
 - 4. 10 minutes

Q.6 A shopkeeper offers a discount of 10% on an article and gains 15%. Calculate the marked price of an article which he purchased for ₹1,350.

- Ans
- 1. ₹1,450
 - 2. ₹1,550
 - 3. ₹1,630
 - 4. ₹1,725

Q.7 If the income of P is 25% less than Q, then the combined income of P and Q is what percentage more than P?

- Ans
- 1. 25%
 - 2. 133.33%
 - 3. 125%
 - 4. 75%

Q.8 A, B and C can do a piece of work in 10 days, 20 days and 40 days, respectively. On the first day A is assisted by the second day C assists A. This 2-day cycle is repeated starting with A and B, till the work gets completed. How whole number of days) would it take to complete the work?

- Ans
- 1. 6
 - 2. 10
 - 3. 8
 - 4. 4

Q.9 The sum of money A initially had was 20% less than the sum of money B had. If B gave 16% of her money to her brother, by what percentage should A's sum increase so that A and B finally have identical amounts?

- Ans
- 1. 6%
 - 2. 4%
 - 3. 4.5%
 - 4. 5%

Q.10 Select the correct statement.

- Ans
- 1. $\text{Loss \%} = \frac{\text{SP} - \text{CP}}{\text{CP}} \times 100$
 - 2. $\text{Profit \%} = \frac{\text{SP} - \text{CP}}{\text{CP}} \times 100$
 - 3. $\text{Loss \%} = \frac{\text{SP} + \text{CP}}{\text{CP}} \times 100$
 - 4. $\text{Profit \%} = \frac{\text{CP} - \text{SP}}{\text{CP}} \times 100$

Q.11 Radha invested a certain sum on simple interest, which will amount to ₹16,200 in 3 years and to ₹17,400 in 4 years. Find the sum she invested.

- Ans
- 1. ₹13,800
 - 2. ₹12,600
 - 3. ₹11,400
 - 4. ₹14,000

Q.12 Find the sum of all those prime numbers which are less than 28.

- Ans
- 1. 120
 - 2. 100
 - 3. 97
 - 4. 110

Q.13 The LCM of $\frac{9}{10}$, $\frac{12}{25}$, $\frac{18}{35}$, $\frac{21}{40}$ is:

- Ans
- 1. $\frac{252}{5}$
 - 2. $\frac{151}{7}$
 - 3. $\frac{100}{9}$
 - 4. $\frac{9}{100}$

Q.14 The area of a right triangle is 48 m^2 and one of the two sides containing the right angle is 8 m long. What is the length of the other side containing the right angle?

- Ans**
- 1. 6
 - 2. 24
 - 3. 16
 - 4. 12

Q.15 Find the compound interest (in ₹) on ₹24,000 at 10% per annum for 3 years?

- Ans**
- 1. 7944
 - 2. 7200
 - 3. 7494
 - 4. 7044

Section : Computer Proficiency

Q.1 Which of the following is used to move a selected text from one place to another in MS word 365?

- Ans**
- 1. Cut-Copy
 - 2. Copy-Copy
 - 3. Cut-Paste
 - 4. Copy-Paste

Q.2 Where is the Help button located in MS-Word 2010?

- Ans**
- 1. Top left corner
 - 2. Top right corner
 - 3. Lower right corner
 - 4. Lower left corner

Q.3 In MS Excel 365, which option in Microsoft Excel allows you to move the selected text or cells to a different worksheet or workbook?

- Ans**
- 1. Print
 - 2. Copy
 - 3. Move
 - 4. Cut

Q.4 Which of the following tabs in the MS Word 365, ribbon has the Spelling and Grammar option?

- Ans**
- 1. Layout
 - 2. Edit
 - 3. Review
 - 4. Insert

Q.5 Which Internet access technique uses the existing cable television infrastructure to provide high-speed Internet access to users?

- Ans**
- 1. DSL (Digital Subscriber Line)
 - 2. Dial-up
 - 3. Fiber-optic
 - 4. Cable Internet

Q.6 _____ is used to describe the page direction in which the contents of the page are to be displayed or printed in Microsoft Word 365.

- Ans
- 1. Page orientation
 - 2. Page size
 - 3. Columns
 - 4. Page margin

Q.7 In MS Excel 365, what is the shortcut to move to the last cell on a worksheet, to the lowest used row of the rightmost used column?

- Ans
- 1. Ctrl + Home
 - 2. Ctrl + End
 - 3. Shift + End
 - 4. Shift + Home

Q.8 What is the primary purpose of creating a table in Microsoft Word 365?

- Ans
- 1. For enhancing the page layout and margins
 - 2. For organising and presenting information in rows and columns
 - 3. For adding decorative elements to the document
 - 4. For applying font styles and colours to text

Q.9 Which is the correct syntax for writing SUMIF() function in MS Excel?

- Ans
- 1. SUMIF(range)
 - 2. SUMIF(range, criteria)
 - 3. SUMIF(range, criteria, [sum_range])
 - 4. SUMIF(criteria)

Q.10 Which of the following is a unique identifier for each user, typically in the format of name@domain.com?

- Ans
- 1. Email client
 - 2. Email server
 - 3. Email address
 - 4. Password

Prepare 50% Faster

Constable Executive Male and Female in Delhi Police Examination 2023

Exam Date	28/11/2023
Exam Time	9:00 AM - 10:30 AM
Subject	Constable Executive Male and Female in Delhi Police Examination 2023

Section : General Knowledge

Q.1 The structures of temples located in India are classified as phamsana and latina on the basis of which of their parts?

- Ans**
- 1. Garbagriha
 - 2. Shikhara
 - 3. Amalaka
 - 4. Mandap

Q.2 At what degree from the epicentre does the seismograph record the arrival of P-waves but NOT S-waves?

- Ans**
- 1. Within 90°
 - 2. Beyond 105°
 - 3. Between 90° and 115°
 - 4. Beyond 145°

Q.3 Select the correct sequence of the following steps during the process of photosynthesis.

- i. Chlorophyll helps in absorbing light energy.
- ii. Light energy is converted into chemical energy and the water molecule is split into oxygen and hydrogen molecules.
- iii. Carbon dioxide is converted into carbohydrates.

- Ans**
- 1. Step i and step ii always occur together and step iii can occur any other time
 - 2. These steps need not occur one after another immediately
 - 3. Step i occurs first and steps ii and iii occur together next
 - 4. They always occur sequentially in the order i → ii → iii

Q.4 Which of the following dance forms is performed by the tribal people of Andhra Pradesh?

- Ans**
- 1. Dhimsa
 - 2. Bihu
 - 3. Jawara
 - 4. Garba

Q.5 Kummi dance, usually performed during harvest festivals and Navratri, is a popular dance of which southern state?

- Ans**
- 1. Andhra Pradesh
 - 2. Telangana
 - 3. Karnataka
 - 4. Tamil Nadu

Q.6 Which of the following Articles of the Indian Constitution states that 'The Directive Principles of State Policy are fundamental in the governance of the country and it shall be the duty of the State to apply the Principles in making laws'?

- Ans**
- 1. Article 36
 - 2. Article 38
 - 3. Article 37
 - 4. Article 51

Q.7 Sarva Shiksha Abhiyan is a flagship programme of the government of India, that was started in 2001 to achieve _
Ans 1. Universalisation of Pre-primary Education (UPPE)
 2. Universalisation of Higher Education (UHE)
 3. Universalisation of School Education (USE)
 4. Universalisation of Elementary Education (UEE)

Q.8 Who among the following is a famous Chhau dancer?

Ans 1. Sadashiva Pradhan
 2. Alloka Kanungo
 3. Pratibha Prahlad
 4. Chhaya Khutegaonkar

Q.9 The Stupa sculptures found at Sanghol in Punjab belongs to which of the following schools?

Ans 1. Sarnath
 2. Amravati
 3. Gandhara
 4. Mathura

Q.10 Which of the following cricketers has written the autobiography titled 'At the Close of Play'?

Ans 1. Matthew Hayden
 2. Chris Gayle
 3. Kevin Pieterse
 4. Ricky Ponting

Q.11 Swami Vivekananda established which of the following social organisations in 1897?

Ans 1. Prarthana Samaj
 2. Arya Samaj
 3. Ramakrishna Mission
 4. Paramhansa Sabha

Q.12 The fundamental objective of the second five year plan was to initiate and accelerate the process of _____ so that the development of Indian economy takes a firm base.

Ans 1. globalisation
 2. industrialisation
 3. privatisation
 4. liberalisation

Q.13 The Halda festival of Himachal Pradesh is primarily celebrated by which religious community?

Ans 1. Buddhist
 2. Jain
 3. Hindu
 4. Parsi

Q.14 The famous tripartite struggle between the Gurjara-Pratihara, Rashtrakuta and Pala dynasties was fought for control over _____.

Ans 1. Manyakheta
 2. Avanti
 3. Kannauj
 4. Panipat

Q.15 The Teesta low dam is located in which of the following states?

- Ans
- 1. Bihar
 - 2. Tripura
 - 3. Sikkim
 - 4. Arunachal Pradesh

Q.16 Schedule A of the Industrial Policy Resolution 1956 comprised of industries which would be:

- Ans
- 1. owned by both private and public sector
 - 2. exclusively owned by foreign nationals
 - 3. exclusively owned by the state
 - 4. in the private sector

Q.17 Which of the following is an example of the most 'Liquid form of Money'?

- Ans
- 1. Currency notes
 - 2. Bonds
 - 3. Fixed deposit receipts
 - 4. National savings deposits

Q.18 Hydrogenation of vegetable oils is catalysed by _____.

- Ans
- 1. Ni
 - 2. Fe
 - 3. Cu
 - 4. Al

Q.19 The term 'slip' is related to which of the following games?

- Ans
- 1. Badminton
 - 2. Football
 - 3. Hockey
 - 4. Cricket

Q.20 The interim Government was provisioned under which Plan/Act of the Government of India, by the Britishers?

- Ans
- 1. Government of India Act, 1935
 - 2. Cabinet Mission Plan
 - 3. Cripps Mission Plan
 - 4. Government of India Act, 1919

Q.21 Part _____ of the Constitution of India deals with the Union Executive.

- Ans
- 1. VI
 - 2. I
 - 3. V
 - 4. III

Q.22 In which of the following years was the Central Vigilance Commission set up by the Government of India?

- Ans
- 1. 1975
 - 2. 1964
 - 3. 1984
 - 4. 1970

Q.23 The 'Population Projection' in demographics refers to _____.

- Ans
- 1. measuring the population growth rate
 - 2. estimating future population size based on past data and trends
 - 3. calculating the population density of a region
 - 4. identifying the sex ratio in a particular area

Q.24 Which of the following nations won the inaugural under-19 women's cricket world championship?

- Ans
- 1. India
 - 2. Australia
 - 3. England
 - 4. New Zealand

Q.25 Madhu Mansuri Hasmukh is a singer, song writer and activist from the state of _____.

- Ans
- 1. Andhra Pradesh
 - 2. Chhattisgarh
 - 3. Jharkhand
 - 4. Madhya Pradesh

Q.26 Which mountain range includes the Shiwalik range as a part?

- Ans
- 1. Himalayas
 - 2. Western Ghats
 - 3. Aravalli
 - 4. Eastern Ghats

Q.27 The main source of ocean heat is _____.

- Ans
- 1. air
 - 2. minerals under water
 - 3. gases under water
 - 4. sunlight

Q.28 The Finance Commission submits its report to the:

- Ans
- 1. Prime Minister of India
 - 2. Parliament
 - 3. President of India
 - 4. Finance Minister

Q.29 Which of the following is NOT a Fundamental Duty?

- Ans
- 1. To develop the scientific temper
 - 2. To value rich heritage
 - 3. To protect the natural environment
 - 4. To pay income tax in time

Q.30 If nominal GDP is ₹1,800 and real GDP is ₹1,000. What will be the value of GDP deflator?

- Ans
- 1. 200%
 - 2. 180%
 - 3. 150%
 - 4. 190%

Q.31 In 2022, Air India was privatised. Which of the following private business groups has taken over Air India?

- Ans**
- 1. TATA
 - 2. Birla
 - 3. Reliance
 - 4. Adani

Q.32 'Kim', the English novel about a boy, was written by which of the following authors?

- Ans**
- 1. Jerome K Jerome
 - 2. Rudyard Kipling
 - 3. Ruskin Bond
 - 4. Joseph Conrad

Q.33 Which among the following states has the lowest poverty ratio as per the Multidimensional Poverty Index (2021) of the NITI Aayog?

- Ans**
- 1. Kerala
 - 2. Sikkim
 - 3. Tamil Nadu
 - 4. Goa

Q.34 The 'Valmiki Ambedkar Awas Yojana' (VAMBAY) was launched in which year by the Government of India?

- Ans**
- 1. 2007
 - 2. 2003
 - 3. 2001
 - 4. 2005

Q.35 Articles 36 to 51 of the Indian Constitution does NOT deal with which issues?

- Ans**
- 1. Secure a social order for promotion of welfare of the people
 - 2. Control of economic fluctuations for the benefits of a person or group
 - 3. Secure suitable legislation and living wage for workers
 - 4. Equal justice and free legal aid

Q.36 Name the employee of the East India Company who deciphered Asokan Brahmi in 1830s.

- Ans**
- 1. William Crookes
 - 2. James Mills
 - 3. William Risley
 - 4. James Prinsep

Q.37 Which state of the matter has LEAST force of attraction between its particles?

- Ans**
- 1. Plasma
 - 2. Liquid
 - 3. Solid
 - 4. Gas

Q.38 The disintegration of the Bahamani Empire gave rise to _____ independent kingdoms in Deccan.

- Ans**
- 1. four
 - 2. seven
 - 3. five
 - 4. two

Q.39 Which of the following is NOT a Directive Principle of State Policy?

- Ans
- 1. Valuing the rich heritage of our culture
 - 2. Separation of judiciary from executive
 - 3. Uniform civil code for the citizens
 - 4. Promotion of co-operative societies

Q.40 Tamladu is the religious festival of the Digaru Mishmis tribe of which Indian state?

- Ans
- 1. Odisha
 - 2. Arunachal Pradesh
 - 3. Jharkhand
 - 4. Madhya Pradesh

Q.41 In which of the following years was the Arjuna Award started in India?

- Ans
- 1. 1964
 - 2. 1963
 - 3. 1961
 - 4. 1962

Q.42 Which of the following is the major reservoir of carbon on earth?

- Ans
- 1. Lakes
 - 2. Ponds
 - 3. Ocean
 - 4. Rivers

Q.43 Tanjore Bala saraswati was a prominent dancer of which form of Indian Classical Dance?

- Ans
- 1. Manipuri
 - 2. Kuchipudi
 - 3. Odissi
 - 4. Bharatanatyam

Q.44 In India, there are various crops produced. Which group of crops belong to the pulses?

- Ans
- 1. Tea and coffee
 - 2. Gram and tur
 - 3. Jute and cotton
 - 4. Wheat and rice

Q.45 Which of the following Statutory Commissions was set up to study the working of the government after the Government of India Act 1919 was passed?

- Ans
- 1. The Butler Commission
 - 2. The Simon Commission
 - 3. The Campbell Commission
 - 4. The Hunter Commission

Q.46 What was the fraction of sales price collected as tax under the Mauryans?

- Ans
- 1. $\frac{1}{5}$
 - 2. $\frac{1}{15}$
 - 3. $\frac{1}{10}$
 - 4. $\frac{1}{20}$

Q.47 Who among the following established the Academy of Performing Arts and Research in Switzerland?

- Ans
- 1. Pandit Kumar Gandharva
 - 2. Pandit Bhimsen Joshi
 - 3. Pandit Jasraj
 - 4. Dr. M Balamuralikrishna

Q.48 Who founded the Abhinav Bharat Society?

- Ans
- 1. Lala Hardayal
 - 2. Savarkar Brothers
 - 3. Madan Lal Dhingra
 - 4. P Mitra

Q.49 In which year did India qualify for the FIFA World Cup?

- Ans
- 1. 1954
 - 2. 1958
 - 3. 1946
 - 4. 1950

Q.50 Which of the following statements is/are true about globalisation?

- I. It is about integration with world economies
- II. It promotes competition among producers
- III. Appreciation of domestic currency improves exports

- Ans
- 1. Only I and III
 - 2. Only I
 - 3. Only I and II
 - 4. Only II and III

Section : Reasoning

Q.1 A paper is folded and cut as shown below. How will it appear when unfolded?

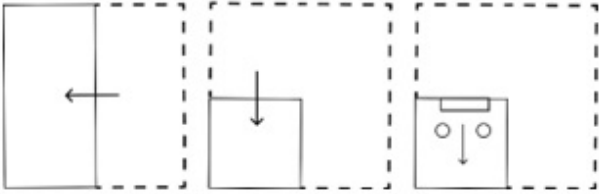

Ans

✓ 1.

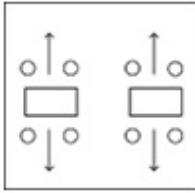

✗ 2.

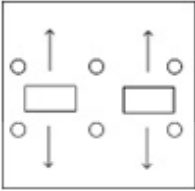

✗ 3.

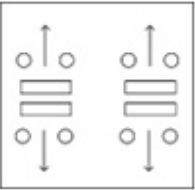

✗ 4.

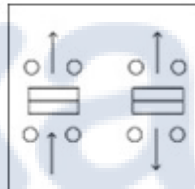

Q.2 Which of the following terms will replace the question mark (?) in the given series?
RTV, PQR, ?, LKJ, JHF

- Ans
- ✗ 1. MNM
 - ✓ 2. NNN
 - ✗ 3. MNO
 - ✗ 4. NOM

Q.3 Select the option that is related to the third term in the same way as the second term is related to the first term and the sixth term is related to the fifth term.
5 : 45 :: 4 : ? :: 12 : 108

- Ans
- ✗ 1. 48
 - ✓ 2. 36
 - ✗ 3. 40
 - ✗ 4. 24

Q.4 Select the option that is related to the fifth letter cluster in the same way as the second letter cluster is related to the first letter cluster and the fourth letter cluster is related to the third letter cluster.
KGMQ : EQGA :: LZUD : FJON :: JRCO : ?

- Ans
- ✗ 1. DNSY
 - ✗ 2. KXWB
 - ✓ 3. DBWY
 - ✗ 4. KRWY

Q.5 Select the option in which the given figure is embedded (rotation is NOT allowed).



Ans

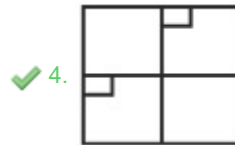
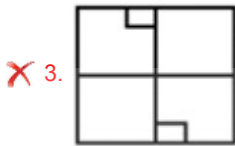
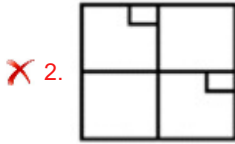
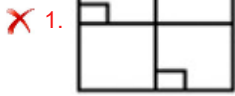

Q.6 Six letters P, Q, R, S, T and U are written on different faces of a dice. Two positions of this dice are shown in the figure. Find the letter on the face opposite to 'R'.

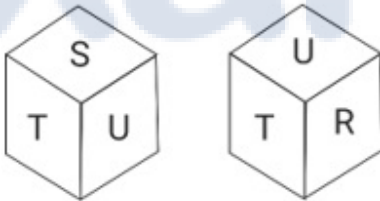

Ans ✗ 1. Q

✓ 2. S

✗ 3. T

✗ 4. P

Q.7 Select the correct combination of mathematical signs to sequentially replace the * signs and to balance the given equation.
 $658 * 14 * 3 * 32 * 56 * 165$

Ans ✗ 1. = + × - +

✗ 2. + × + - =

✓ 3. + × - + =

✗ 4. × + - + =

Q.8 A paper is folded and cut as shown below. How will it appear when unfolded?

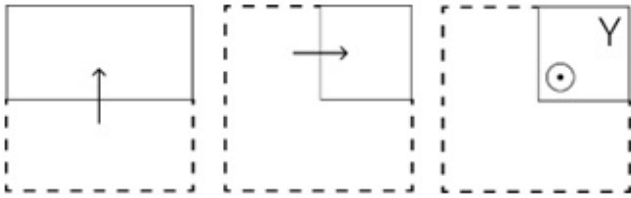

Ans

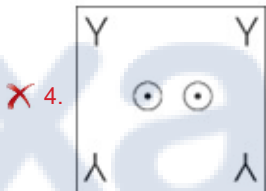
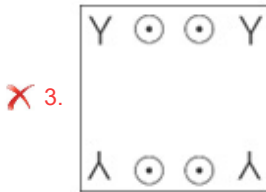
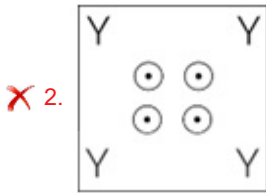
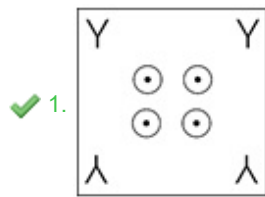

Q.9 Select the number from among the given options that can replace the question mark (?) in the following series.

7, 11, 23, 59, 167, ?

Ans ✓ 1. 491

✗ 2. 678

✗ 3. 324

✗ 4. 346

Prepare 50% Faster

Q.10 A paper is folded and cut as shown below. How will it appear when unfolded?

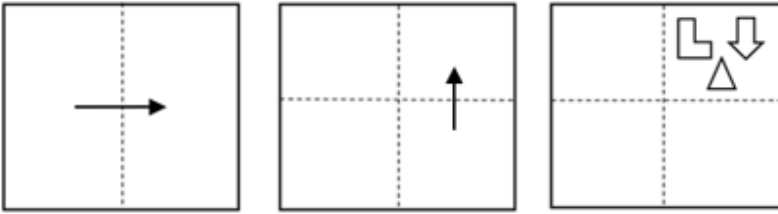

Ans

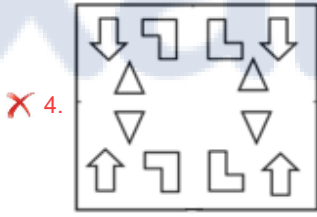
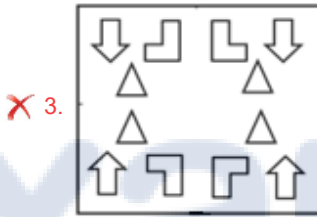
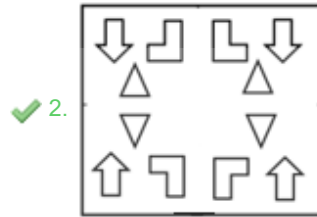
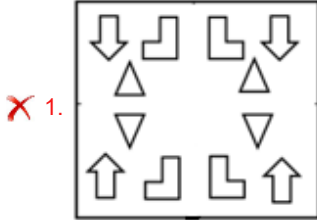

Prepare 50% Faster

Q.11 Which figure should replace the question mark (?) if the following series were to be continued?

Y	I	L	D	O	L	Y	I	C	Y						
C	Z	D	I	C	Z	Z	D	I	L	Z	D	D	I	L	?
O		L	Y	O	C		Y	O	C	Z	O				

Ans

✗ 1.

O	C	
I	L	D
Y	Z	

✗ 2.

Y	O	
L	D	I
C	Z	

✗ 3.

Z	L	
Y	D	I
O	C	

✓ 4.

O	L	
Y	D	I
C	Z	

Q.12 How many triangles are there in the given figure?

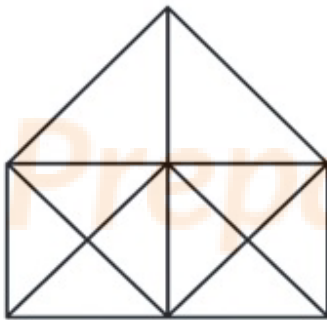

Ans ✓ 1. 23

✗ 2. 28

✗ 3. 32

✗ 4. 25

Q.13 Select the option figure that will replace the question mark (?) in the figure given below to complete the pattern.

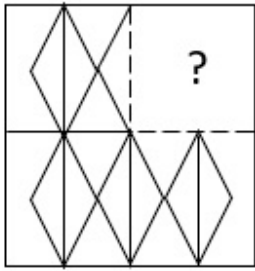

Ans

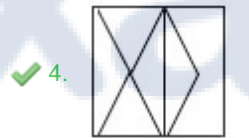
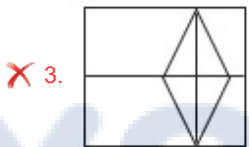
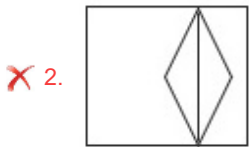
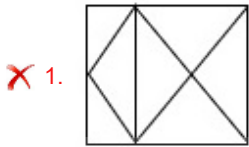

Q.14 In a certain code language, 'PENCIL' is written as 'NEPLIC' and 'ERASER' is written as 'ARERES'. How will 'GEOMETRY' be written in that language?

- Ans
- ✗ 1. MEOGRYTE
 - ✗ 2. MEOGRRTE
 - ✓ 3. MOEGYRTE
 - ✗ 4. MEOGYRET

Q.15 Select the option in which the given figure is embedded. (Rotation is NOT allowed.)



Ans

✗ 1.

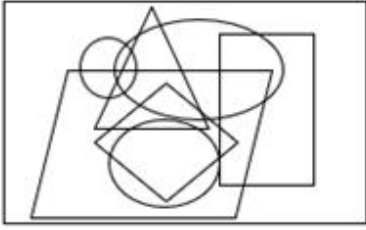

✗ 2.

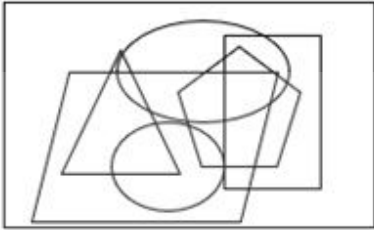

✗ 3.



✓ 4.



Q.16 Select the correct mirror image of the given figure when the mirror is placed at MN as shown below.

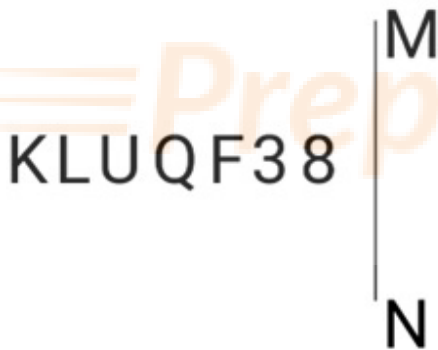

Ans

✗ 1.

8EFQULJ

✗ 2.

83FQULJ

✗ 3.

83FQULJ

✓ 4.

8EF38

Q.17 Which figure should replace the question mark (?) if the series were to be continued?

6	8	2	X	6	8	8	X	6	↑	8	X	
X	♥	=	2	=	↑	↑	2	=	6	=	♥	?
	↑			♥		♥			2			

Ans

✗ 1.

X	2	↑
♥	8	6
=		

✗ 2.

6	↑	8
X	♥	2
=		

✓ 3.

X	↑	8
♥	6	=
2		

✗ 4.

8	X	♥
↑	6	=
2		

Q.18 If + means -, - means ×, × means ÷ and ÷ means +, what is the value of the following expression?

$$8 - 2 + 6 \times 3 \div 5$$

Ans ✓ 1. 19

✗ 2. 23

✗ 3. 21

✗ 4. 20

Q.19 Select the set in which the numbers are related in the same way as are the numbers of the following sets.

(NOTE : Operations should be performed on the whole numbers, without breaking down the numbers into its constituent digits. E.g. 13 – Operations on 13 such as adding/deleting/multiplying etc. to 13 can be performed. Breaking down 13 into 1 and 3 and then performing mathematical operations on 1 and 3 is not allowed)

(3, 198, 6)

(5, 495, 9)

Ans ✓ 1. (4, 352, 8)

✗ 2. (5, 424, 8)

✗ 3. (7, 827, 11)

✗ 4. (9, 1288, 12)

Q.20 Select the correct mirror image of the given combination when the mirror is placed at MN as shown below.

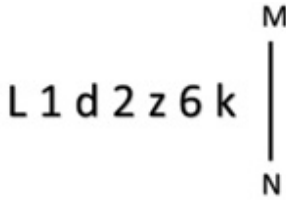

- Ans
- ✓ 1. k 2 z 6 1 d 2 z 6 k
 - ✗ 2. k 2 z 6 1 d 2 z 6 k
 - ✗ 3. k 2 z 6 1 d 2 z 6 k
 - ✗ 4. k 2 z 6 1 d 2 z 6 k

Q.21 Select the figure from among the given options that can replace the question mark (?) in the following series.

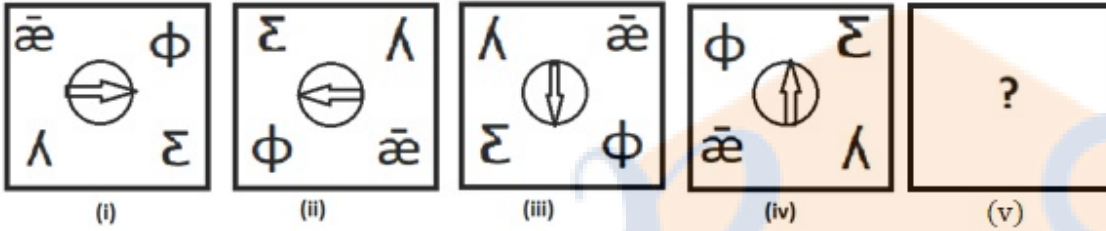

- Ans
- ✗ 1.
 - ✓ 2.
 - ✗ 3.
 - ✗ 4.

Q.22 Seven friends, Gauri, Vinod, Ridima, Jiya, Ritik, Vishal and Karishma, are sitting on a circular bench, facing towards the centre but not necessarily in the same order. Vinod and Jiya are not the neighbours of Ritik. Karishma is sitting third to the left of Ritik. Gauri is sitting to the immediate right of Karishma. Ridima is sitting to the immediate left of Ritik. Who is sitting second to the right of Gauri?

- Ans
- ✗ 1. Jiya
 - ✗ 2. Ridima
 - ✓ 3. Ritik
 - ✗ 4. Vinod

Q.23 Select the correct mirror image of the given figure when the mirror is placed at PQ as shown below.



Ans

- ✗ 1. _)(*88e0VV^^
- ✓ 2. _()*88e0VV^^
- ✗ 3. _()*88e0VV^^
- ✗ 4. _()*880eVV^^

Q.24 Select the option in which the given figure is embedded (rotation is NOT allowed).

Ans

- ✗ 1.
- ✓ 2.
- ✗ 3.
- ✗ 4.

Q.25 Two statements are given followed by two conclusions numbered I and II. Assuming the statements to be true, evaluate which of the conclusions logically follow(s) from the statements.

Statements:
All bats are balls.
All balls are wickets.

Conclusions:
I. All wickets are balls.
II. All bats are wickets.

- Ans**
- 1. Only conclusion I follows
 - 2. Both conclusions I and II follow
 - 3. Neither conclusion I nor II follows
 - 4. Only conclusion II follows

Section : Numerical Ability

Q.1 What is the area of a triangle whose sides are of lengths 9 cm, 40 cm and 41 cm?

- Ans**
- 1. 180 cm²
 - 2. 160 cm²
 - 3. 170 cm²
 - 4. 210 cm²

Q.2 A dealer sells an item for ₹500 by making a profit of 25%. He sells another item at a loss of 10%, and on the whole, makes neither profit nor loss. What did the second item cost him?

- Ans**
- 1. ₹1,000
 - 2. ₹800
 - 3. ₹750
 - 4. ₹500

Q.3 Let N be a three-digit positive integer such that the unit digit of N is prime and the product of all the digits of N is also prime. The number of possible values of N is:

- Ans**
- 1. 12
 - 2. 3
 - 3. 4
 - 4. 8

Q.4 Anil's income is 18% more than Ramesh's income. By what percentage is Ramesh's income less than Anil's income?

- Ans**
- 1. 18.25%
 - 2. 15.25%
 - 3. 10.25%
 - 4. 12.25%

Q.5 The average of 6 terms is 30. The first term is twice the sum of the remaining terms. Find the first term.

- Ans**
- 1. 100
 - 2. 60
 - 3. 120
 - 4. 80

Q.6 Simplify $\frac{6.1 \times 61 \times 6.1 - 1}{6.1 \times 6.1 + 6.1 + 1}$.

- Ans**
- 1. 4.1
 - 2. 3.1
 - 3. 6.1
 - 4. 5.1

Q.7 Namita deposited ₹9,000 which amounted to ₹10,200 after 3 years at simple interest per annum. Had the interest been more, what amount (in ₹) would she get?

- Ans
- 1. 11260
 - 2. 10740
 - 3. 12480
 - 4. 11400

Q.8 If 66 cm³ of silver is drawn into a wire having a diameter of 2 mm, then the length of the wire, in m, will be: (Use $\pi = \frac{22}{7}$)

- Ans
- 1. 27
 - 2. 21
 - 3. 15
 - 4. 23

Q.9 A book is sold at three successive discounts of 20%, 30% and 10%. The net discount in percentage is:

- Ans
- 1. 49.60%
 - 2. 60%
 - 3. 37.60%
 - 4. 47.60%

Q.10 P and Q can finish a work individually in 30 and 45 days, respectively. P starts the work and works alone for 5 days. Then Q joins him and they work together for 6 days, after which P leaves. The part of the work left at that point is:

- Ans
- 1. 0.2
 - 2. 0.4
 - 3. 0.5
 - 4. 0.6

Q.11 The ratio of the sixth and seventh terms of the sequence 1, 3, 6, 10, ... is:

- Ans
- 1. 3 : 4
 - 2. 5 : 3
 - 3. 4 : 3
 - 4. 3 : 5

Q.12 A train moving at uniform speed crosses a pole in 3 seconds and a 700 m long bridge in 10 seconds. What is the speed of the train?

- Ans
- 1. 150 m/s
 - 2. 110 m/s
 - 3. 120 m/s
 - 4. 100 m/s

Q.13 A moneylender borrows money at 4% per annum and pays the interest at the end of the year. He lends it at 8% per annum compound interest, compounded half-yearly, and receives the interest at the end of the year. In this way, he gains ₹166.4 a year. Find the amount of money he borrows.

- Ans
- 1. ₹6,500
 - 2. ₹4,000
 - 3. ₹5,050
 - 4. ₹4,500

Q.14 In a chief election, a candidate got 55% of the total valid votes. 6% of the total votes were declared invalid. If the total number of votes is 30,000, then the number of valid votes polled in favour of the candidate is:

- Ans**
- 1. 15,510
 - 2. 15,500
 - 3. 15,000
 - 4. 16,000

Q.15 The average of the prime numbers between 57 and 99 (both inclusive) is:
(Rounded off to one decimal place)

- Ans**
- 1. 75.4
 - 2. 85.6
 - 3. 87.7
 - 4. 79.3

Section : Computer Proficiency

Q.1 Which of the following is NOT a Change Case option in MS word 365?

- Ans**
- 1. Uppercase
 - 2. Toggle case
 - 3. Sentence case
 - 4. Page case

Q.2 What is the primary differentiating factor between broadband and dialup connections offered by ISPs?

- Ans**
- 1. Dialup connections offer higher security levels than broadband.
 - 2. Dialup offers unlimited data usage, unlike broadband.
 - 3. Dialup connections are wireless, while broadband requires wired connections.
 - 4. Broadband provides faster internet speeds compared to dialup.

Q.3 Which of the following options quickly changes the font of the selected text in Microsoft Word 365 without opening the Font dialog box?

- Ans**
- 1. Right-click and select "Font"
 - 2. Double-click the text
 - 3. Press Ctrl + + F
 - 4. Use the Font drop-down menu on the Status bar

Q.4 What is the purpose of the Help feature in Microsoft Word 365?

- Ans**
- 1. To provide assistance in creating documents
 - 2. To provide access to online tutorials and resources
 - 3. To allow customisation of the user interface
 - 4. To offer grammar and spelling suggestions

Q.5 How do you change the font style and size of selected text in MS-Excel 365?

- Ans**
- 1. Apply a new cell style to the selected text.
 - 2. Right-click the text and choose 'Font'.
 - 3. Press the 'Ctrl+F' shortcut keys together.
 - 4. Access the 'Home' tab, use the 'Font' group.

Q.6 In a worksheet, there is a list of student scores in a column. To count the number of students who scored above 100, which Excel 365 function should be used?

- Ans**
- 1. COUNT
 - 2. COUNTA
 - 3. COUNTIF
 - 4. COUNTBLANK

Q.7 Which of the following is the correct option to create a table in MS-Word 2010?

- Ans**
- 1. Home Tab -> Create Table
 - 2. Create Tab -> Insert Table
 - 3. Home Tab -> Insert Table
 - 4. Insert Tab -> Table Button

Q.8 Which of the following functions is executed in MS Word 365 when Ctrl + V is used?

- Ans**
- 1. Copy the data
 - 2. Cut the data
 - 3. Select all the data
 - 4. Paste the data

Q.9 Which of the following chart types is best suited for showing trends over time?

- Ans**
- 1. Scatter plot
 - 2. Line chart
 - 3. Pie chart
 - 4. Bar chart

Q.10 The _____ symbol is employed to separate the username and domain name within an email address.

- Ans**
- 1. @
 - 2. . (dot)
 - 3. \$
 - 4. &

Prepare 50% Faster

Constable Executive Male and Female in Delhi Police Examination 2023

Exam Date	28/11/2023
Exam Time	12:00 PM - 1:30 PM
Subject	Constable Executive Male and Female in Delhi Police Examination 2023

Section : General Knowledge

Q.1 Which of the following is the oldest atomic power plant of India?

- Ans**
- 1. Narora
 - 2. Tarapur
 - 3. Kakrapar
 - 4. Kaiga

Q.2 Some qualities of Samudragupta are shown on coins, such as on one of the coins he is shown playing the _____.

- Ans**
- 1. veena
 - 2. bansuri
 - 3. Table
 - 4. sarangi

Q.3 Which Treaty resulted in the demarcation of territories between Ranjit Singh and the East India Company?

- Ans**
- 1. Amritsar
 - 2. Lahore
 - 3. Bhaironwal
 - 4. Surat

Q.4 Which of the following Constitutional Amendment Acts has created the Union territories in India?

- Ans**
- 1. 6th
 - 2. 5th
 - 3. 7th
 - 4. 4th

Q.5 Which of the following is NOT included in Article 19 of the Constitution of India?

- Ans**
- 1. To practice any profession or occupation
 - 2. To reside and settle in any part of India
 - 3. To prohibit ineligibility in respect of employment
 - 4. To form associations and unions

Q.6 As per Article 350 B of the Constitution of India, who appoints the Special Officer for Linguistic Minorities?

- Ans**
- 1. Prime Minister
 - 2. Chief Justice of India
 - 3. Governor
 - 4. President

Q.7 When was the first edition of the Durand Cup played in India?

- Ans**
- 1. 1900
 - 2. 1988
 - 3. 1888
 - 4. 1880

Q.8 Gulabo, a world-renowned dancer, is best known for which of the following dance forms?

- Ans**
- 1. Kalbeliya
 - 2. Ghoomar
 - 3. Pandwani
 - 4. Panthi

Q.9 As per India Skills Report 2022, which Indian state got the first rank with the most employable talent?

- Ans**
- 1. Kerala
 - 2. Goa
 - 3. Maharashtra
 - 4. Uttar Pradesh

Q.10 Who among the following was the Sultan of Delhi sultanate from 1296 A.D. to 1316 A.D.?

- Ans**
- 1. Ghiyasuddin Tughluq
 - 2. Ghiyasuddin Balban
 - 3. Khizr Khan
 - 4. Alauddin Khalji

Q.11 What is the duration of a Kabaddi match?

- Ans**
- 1. Two halves of 30 minutes, with a half time break of 10 minutes
 - 2. Two halves of 45 minutes, with a half time break of 10 minutes
 - 3. Two halves of 20 minutes, with a half time break of 5 minutes
 - 4. Two halves of 40 minutes, with a half time break of 5 minutes

Q.12 The 'Mission Solar Charkha' scheme was launched in the year 2018 by _____ of the Government of India.

- Ans**
- 1. Ministry of Skill Development and Entrepreneurship
 - 2. Ministry of Commerce and Industry
 - 3. Ministry of Rural Development
 - 4. Ministry of Micro, Small and Medium Enterprises

Q.13 Which of the following movements is included in volcanism?

- Ans**
- 1. Metamorphic rock
 - 2. Sedimentary rocks
 - 3. Hard rocks
 - 4. Molten rock

Q.14 'My Dateless Diary' is a novel written by whom among the following authors?

- Ans**
- 1. Robin Singh
 - 2. Ruskin Bond
 - 3. RK Narayan
 - 4. Chetan Bhagat

Q.15 According to the Ministry of Commerce and Industry 2022, which state is the largest producer of grapes?

- Ans**
- 1. Andhra Pradesh
 - 2. West Bengal
 - 3. Maharashtra
 - 4. Arunachal Pradesh

Q.16 Liberalisation means:

- Ans**
- 1. free play of market forces in all sectors with no controls
 - 2. increase in control of government over the private sector
 - 3. reduction in control of government over the private sector
 - 4. increase in restrictions on imports and exports

Q.17 Even in 1990, what proportion of the country's population continued to be employed in agriculture?

- Ans**
- 1. 65%
 - 2. 50%
 - 3. 90%
 - 4. 35%

Q.18 Who conceptualised the idea about animal ecology in 1927?

- Ans**
- 1. Rachel Carson
 - 2. Aldo Leopold
 - 3. Charles Elton
 - 4. Arthur George Tansley

Q.19 Fundamental duties are mentioned in which part of the Indian Constitution?

- Ans**
- 1. Part III-B
 - 2. Part IV-A
 - 3. Part III-A
 - 4. Part II-A

Q.20 In the popular traditions of Vijayanagara, the Deccan Sultans are termed as _____.

- Ans**
- 1. Gajapati
 - 2. Narapati
 - 3. Ashvapati
 - 4. Sherapati

Q.21 NITI Aayog came into existence in 2015. On which date was it formed?

- Ans**
- 1. 1st March
 - 2. 31st January
 - 3. 1st January
 - 4. 15th August

Q.22 Which of the following is NOT a central bank's function?

- Ans**
- 1. Financial services for the government
 - 2. Banking facilities for the public
 - 3. Lending to commercial banks
 - 4. Lending to the government

Q.23 Name the place where “independent” parallel government by Indians was established during the Quit India move mark of revolt against British government.

- Ans
- 1. Satara
 - 2. Kalpi
 - 3. Rohtak
 - 4. Kanpur

Q.24 With which of the following gharanas is Ustad Bade Ghulam Ali Khan associated?

- Ans
- 1. Patiala gharana
 - 2. Agra gharana
 - 3. Banaras gharana
 - 4. Kirana gharana

Q.25 What kind of image does the eye lens form of the object on the retina?

- Ans
- 1. No image
 - 2. Inverted real image
 - 3. Real and opaque image
 - 4. Inverted virtual image

Q.26 Baishagu is celebrated in which of the following states?

- Ans
- 1. Punjab
 - 2. Assam
 - 3. Bihar
 - 4. Goa

Q.27 The Ministry of Rural Development had launched ‘Garib Kalyan Rozgar Abhiyan’ in 2020 to provide immediate employment and livelihood opportunities to returnee migrants and rural population. From which state was the scheme launched?

- Ans
- 1. Rajasthan
 - 2. Bihar
 - 3. Gujarat
 - 4. Uttar Pradesh

Q.28 Which of the following committees observed that “essentially all that is contained in the fundamental duties is just a codification of tasks integral to the Indian way of life”?

- Ans
- 1. Rangrajan committee
 - 2. Verma Committee
 - 3. Santhanam Committee
 - 4. Moily committee

Q.29 Capital market is a market for _____ funds.

- Ans
- 1. long term
 - 2. short term
 - 3. both short term and long term
 - 4. medium term only

Q.30 Which of the following palaces is located in Mysore, Karnataka?

- Ans
- 1. Amba Vilas Palace
 - 2. Ujjayanta Palace
 - 3. Kowdiar Palace
 - 4. Kangla Palace

Q.31 To which of the following places would a school teacher take her students for a field trip to see Hoshang Shah's Hindola Mahal, Champa Baoli and Jahaaz Mahal?

- Ans**
- 1. Mandu, Madhya Pradesh
 - 2. Varanasi, Uttar Pradesh
 - 3. Agra, Uttar Pradesh
 - 4. Ratlam, Madhya Pradesh

Q.32 Who among the following was a renowned pianist and founder of the Shillong Chamber Choir?

- Ans**
- 1. Damon Lyndem
 - 2. Kynsai Lyngdoh
 - 3. William Basaiawmoit
 - 4. Neil Nongkynrih

Q.33 Who among the following was the first headmistress of the country's first school for girls in Pune?

- Ans**
- 1. Pandita Ramabai
 - 2. Annie Besant
 - 3. Vijaya Laxmi Pandit
 - 4. Savitri Bai Phule

Q.34 Which of the following area pair of barrel-shaped organelles located in the cytoplasm of animal cells near the nuclear envelope, which give orientation to the 'mitotic spindle' formed during cell division?

- Ans**
- 1. Flagella
 - 2. Basal bodies
 - 3. Centrioles
 - 4. Centrosomes

Q.35 Who among the following is a Padma Vibhushan awardee and a torch bearer of the Kalka-Bindadin Gharana of Lucknow?

- Ans**
- 1. Pandit Birju Maharaj
 - 2. Pandit Gopi Krishna
 - 3. Pandit Lacchu Maharaj
 - 4. Pandit Shambhu Maharaj

Q.36 Who proposed to pass an Act for the repair and protection of historical monuments of the country?

- Ans**
- 1. Lord Northbrook
 - 2. Lord Curzon
 - 3. Lord Mayo
 - 4. Lord Canning

Q.37 In which of the following years did India host the Asian Games?

- Ans**
- 1. 1955 and 1982
 - 2. 1960 and 1983
 - 3. 1951 and 1982
 - 4. 1951 and 1985

Q.38 Where is the secretariat of the Goods and Services Tax Council located?

- Ans**
- 1. Kolkata
 - 2. New Delhi
 - 3. Mumbai
 - 4. Chandigarh

Q.39 Which of the following earthquake waves is more destructive?

- Ans
- 1. P-Waves
 - 2. Surface waves
 - 3. S-Waves
 - 4. Body Waves

Q.40 Atal Bhujal Yojana (Atal Jal) is targeted at sustainable _____ management.

- Ans
- 1. groundwater
 - 2. pollution
 - 3. waste
 - 4. green

Q.41 Megasthenes, a Greek, was the ambassador in the court of which of the following kings?

- Ans
- 1. Ashoka
 - 2. Mahapadma Nanda
 - 3. Bimbisara
 - 4. Chandragupta Maurya

Q.42 Which of the following dancers is associated with the following two dances - Bharatanatyam and Odissi?

- Ans
- 1. Shovana Narayan
 - 2. Guru Bipin Singh
 - 3. Padma Subrahmanyam
 - 4. Sonal Mansingh

Q.43 What do you mean by 'cant' in kabaddi?

- Ans
- 1. A player in whose court a raid is made
 - 2. A special point is given to an opponent
 - 3. Repeating round of the word 'kabaddi'
 - 4. A player who enters the court

Q.44 Who among the following physicists wrote an autobiography 'Autobiographical Notes'?

- Ans
- 1. Michael Faraday
 - 2. Isaac Newton
 - 3. Albert Einstein
 - 4. James Maxwell

Q.45 Which Article of the Constitution of India mentions that "it shall be the duty of every citizen of India to promote harmony and the spirit of common brotherhood amongst all the people of India transcending religious, linguistic and regional or sectional diversities; to renounce practices derogatory to the dignity of women"?

- Ans
- 1. 51A (a)
 - 2. 51A (d)
 - 3. 51A (k)
 - 4. 51A (e)

Q.46 The Kathiawar Peninsula is a part of which state of India?

- Ans
- 1. West Bengal
 - 2. Gujarat
 - 3. Tamil Nadu
 - 4. Andhra Pradesh

Q.47 Select the INCORRECT combination of festival and its significance.

- Ans**
- 1. Makar Sankranti – Also known as Uttarayana, Lohri, Pongal, Bihu and the Khichdi festival
 - 2. Kartik Purnima – Marks the birth anniversary of Guru Gobind Singh
 - 3. Eid-Milad-ul-Nabi – The birth anniversary of Prophet Muhammad
 - 4. KarvaChauth – Married women observe a fast from sunrise to moonrise

Q.48 Which of the following is the largest, double membrane-bound organelles, which contain all the cell's genetic information?

- Ans**
- 1. Nucleus
 - 2. Lysosome
 - 3. Peroxisomes
 - 4. Ribosome

Q.49 Which of the following dances of Assam is associated with the worship of the snake goddess Manasa?

- Ans**
- 1. Deodhani
 - 2. Bhor Tal Nritya
 - 3. Jhumur
 - 4. Bagurumba

Q.50 Which of the following countries is the second most populous country in South Asia?

- Ans**
- 1. Bangladesh
 - 2. Nepal
 - 3. Afghanistan
 - 4. Pakistan

Section : Reasoning

Q.1 Select the option in which the given figure is embedded (rotation is NOT allowed).

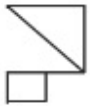

Ans

- 1.
- 2.
- 3.
- 4.

Q.2 Which of the following option figures will complete the pattern in the figure given below?



Ans

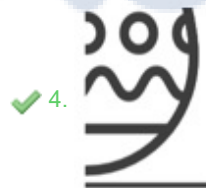
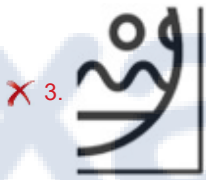
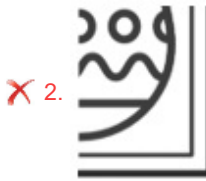
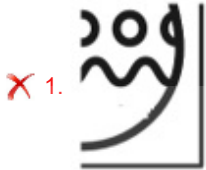

Prepare 50% Faster

Q.3 Select the correct mirror image of the given combination when the mirror is placed at 'MN' as shown below.

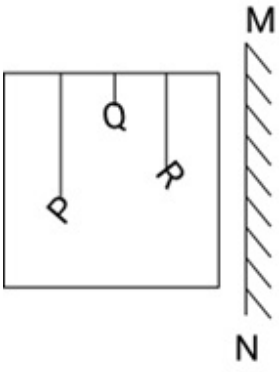

Ans

X 1.

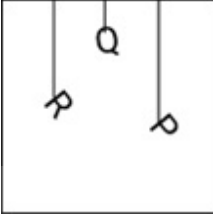

X 2.

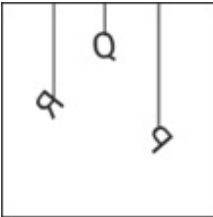

✓ 3.

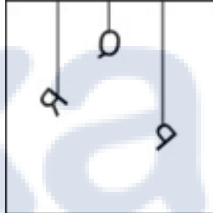

X 4.

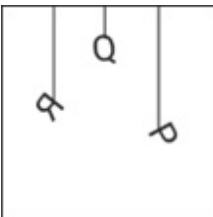



Prepare 50% Faster

Q.4 Select the figure from among the given options that can replace the question mark (?) in the following series.

! \$ # @	@ # \$!	# ! @ \$	\$ @ ! #	?
(i)	(ii)	(iii)	(iv)	(v)

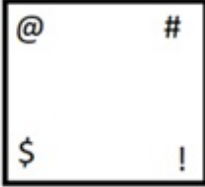
Ans

✓ 1. 

✗ 2. 

✗ 3. 

✗ 4. 

Q.5 Select the option in which the given figure is embedded (rotation is NOT allowed).

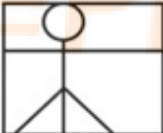

Ans

✗ 1. 

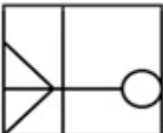
✗ 2. 

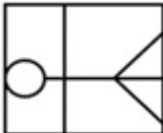
✗ 3. 

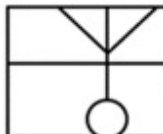
✓ 4. 

Q.6 Which of the following terms will replace the question mark (?) in the given series?

CNWF, FMZE, ?, LKFC, OJIB

- Ans
- 1. IIBC
 - 2. CMBE
 - 3. ILCD
 - 4. CNCD

Q.7 Read the given statements and conclusions carefully. Assuming that the information given in the statements is true, even if it appears to be at variance with commonly known facts, decide which of the given conclusions logically follow(s) from the statements.

Statements:

- All peacocks are lion.
- Some lions are dogs.
- No dog is a cat.

Conclusions:

- I. Some lions are not cats.
- II. Some peacocks are dogs.
- III. Some peacocks are not lion.

- Ans
- 1. Only conclusion III follows
 - 2. Only conclusion II and III follow
 - 3. Only conclusion I follows
 - 4. Conclusions I, II and III follow

Q.8 Select the option that is related to the third term in the same way as the second term is related to the first term and the sixth term is related to the fifth term.

12 : 169 :: 15 : ? :: 25 : 676

- Ans
- 1. 256
 - 2. 289
 - 3. 196
 - 4. 225

Prepare 50% Faster

Q.9 Select the option in which the given figure is embedded (rotation is NOT allowed).

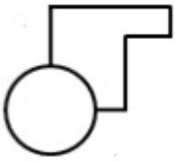

Ans

✓ 1.

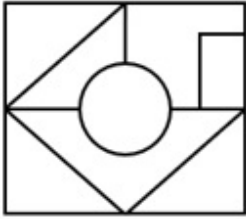

✗ 2.

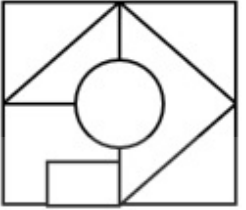

✗ 3.

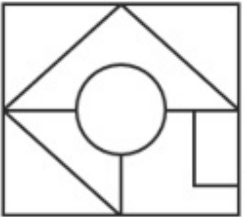

✗ 4.

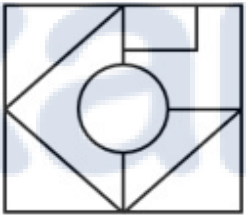

Prepare 50% Faster

Q.10 A paper is folded and cut as shown below. How will it appear when unfolded?

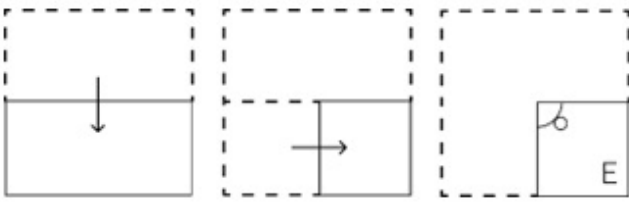

Ans

✗ 1.

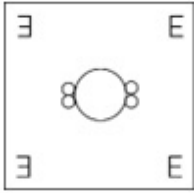

✗ 2.

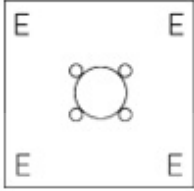

✗ 3.

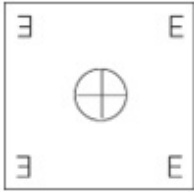

✓ 4.

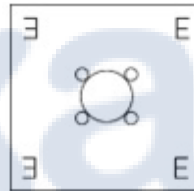

Q.11 Six students are sitting around a circular table facing the centre. Abhay is an immediate neighbour of both Aditi and Amol. Aabha is sitting second to the right of Aditi. Abdul is sitting third to the right of Amol. Aashna is sitting second to the left of Abhay. Who is an immediate neighbour of both Aditi and Aabha?

Ans ✓ 1. Abdul

✗ 2. Amol

✗ 3. Aashna

✗ 4. Abhay

Q.12 In a certain code language, 'DESK' is written as '23179' and 'FLOW' is written as '4101321'. How will 'HUNT' be written in that language?

Ans ✗ 1. 5998795

✗ 2. 5894566

✗ 3. 6111219

✓ 4. 6191218

Q.13 How many triangles are there in the given figure?

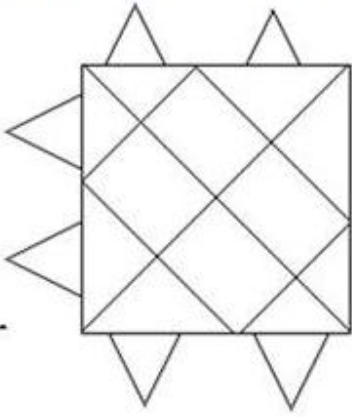

- Ans
- 1. 22
 - 2. 26
 - 3. 28
 - 4. 24

Q.14 Select the number from among the given options that can replace the question mark (?) in the following series.

10, 22, 13, 28, 16, ?

- Ans
- 1. 43
 - 2. 78
 - 3. 67
 - 4. 34

Q.15 Select the set in which the numbers are related in the same way as are the numbers of the following sets.
(NOTE : Operations should be performed on the whole numbers, without breaking down the numbers into its constituent digits. E.g. 13 – Operations on 13 such as adding /deleting /multiplying etc. to 13 can be performed. Breaking down 13 into 1 and 3 and then performing mathematical operations on 1 and 3 is NOT allowed)
(49, 12), (81, 14)

- Ans
- 1. (400, 22)
 - 2. (361, 24)
 - 3. (144, 20)
 - 4. (169, 14)

Prepare 50% Faster

Q.16 Select the figure that will come next in the following figure series.

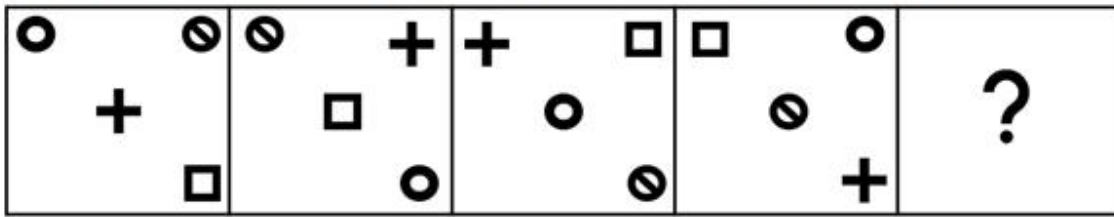

Ans

✗ 1.

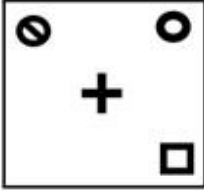

✗ 2.

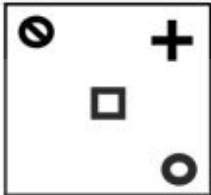

✓ 3.

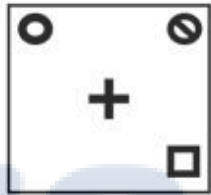

✗ 4.

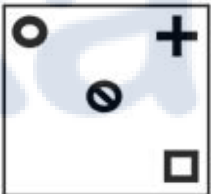

Q.17 Which two signs should be interchanged to make the following equation correct?

$$36 - 9 \times 15 + 8 \div 3 = 65$$

Ans ✓ 1. - and ÷

✗ 2. + and ×

✗ 3. - and +

✗ 4. + and ×

Prepare 50% Faster

Q.18 Select the figure from the given options that will replace the question mark (?) in the figure given below and complete the pattern.

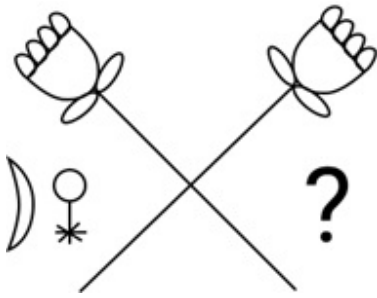

Ans

- 1.
- 2.
- 3.
- 4.

Q.19 Select the option that is related to the third word in the same way as the second word is related to the first word. (The words must be considered as meaningful English words and must NOT be related to each other based on the number of letters/number of consonants/vowels in the word)
Snow : Mountain :: Sand : ?

Ans

- 1. Sun
- 2. Beach
- 3. Bucket
- 4. Water

Q.20 Select the option in which the given figure is embedded (rotation is NOT allowed).



Ans

- 1.
- 2.
- 3.
- 4.

Q.21 Which of the following option figures will complete the pattern in the figure given below?

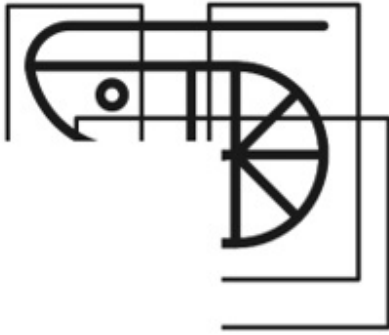

Ans

✓ 1.



✗ 2.



✗ 3.



✗ 4.

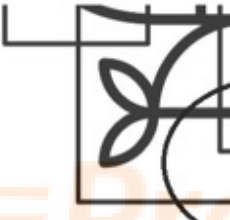

Q.22 Select the correct combination of mathematical signs to sequentially replace the * signs and to balance the given equation.
 $99 * 11 * 5 * 25 * 15 * 5$

Ans ✗ 1. $\div - \times + =$

✗ 2. $- \div \times + =$

✗ 3. $\div - \times = +$

✓ 4. $\div \times - = +$

Q.23

Select the option figure that will replace the question mark (?) in the figure given below to complete the pattern.

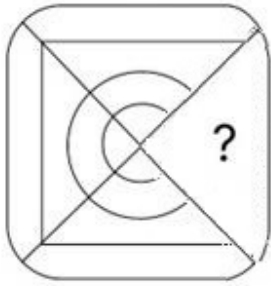

Ans

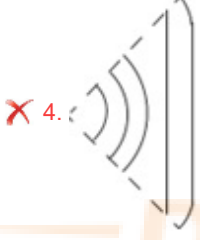
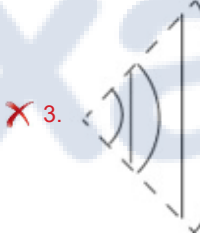
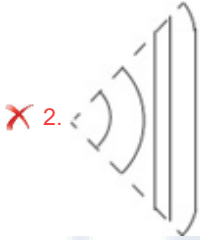
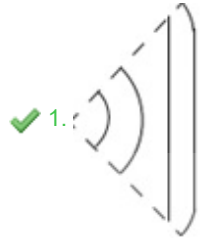

Q.24 The sequence of folding a piece of paper and the manner in which the folded paper is cut is shown in the following figures. How would this paper look when unfolded?

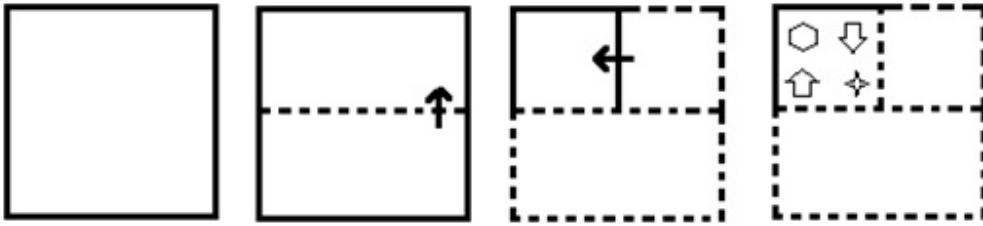

Ans

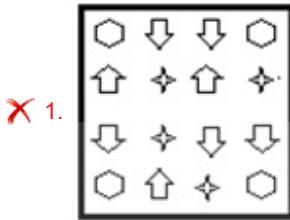

Q.25 Select the figure that will come next in the following figure series.

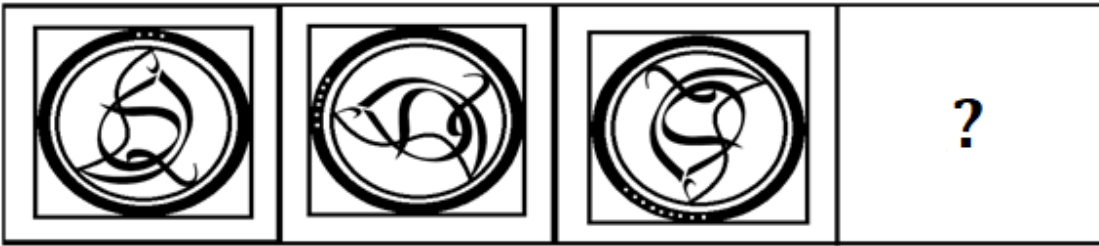

Ans

- 1.
- 2.
- 3.
- 4.

Section : Numerical Ability

Q.1 A shopkeeper tells his associate to put a selling price tag of ₹152 on an item to earn a 12% profit. By mistake, the associate puts the price tag of ₹125. What is the percentage loss or gain of the shopkeeper with the new selling price tag (rounded off to two decimal places)?

- Ans
- 1. 8.77% loss
 - 2. 9.66% profit
 - 3. 6.99% profit
 - 4. 7.89% loss

Q.2 The greatest number by which when numbers 275 and 146 are divided, it leaves remainders 5 and 6, respectively, is:

- Ans
- 1. 15
 - 2. 12
 - 3. 10
 - 4. 8

Q.3 Nithish marks his goods 20% above the cost price but allows a 15% discount for cash payment. If he sells the article for ₹1,020, find his cost price (in ₹).

- Ans
- 1. 1200
 - 2. 1000
 - 3. 1109
 - 4. 1300

Q.4 The ratio of the radius and the height of a cone is 5 : 18. If its volume is $1,61,700 \text{ cm}^3$, find its slant height (in cm).

(Take $\pi = \frac{22}{7}$)

- Ans
- 1. $\sqrt{27108}$
 - 2. $\sqrt{17101}$
 - 3. $\sqrt{27101}$
 - 4. $\sqrt{17108}$

Q.5 A family consists of two grandparents, two parents and two grandchildren. The average age of the grandchildren is 12 years, that of the parents is 40 years and that of the grandparents is 68 years. What is the average age of the family?

- Ans
- 1. 35 years
 - 2. 30 years
 - 3. 40 years
 - 4. 45 years

Q.6 Which of the following numbers is greater than the sum of all the prime factors of 2145?

- Ans
- 1. 31
 - 2. 29
 - 3. 41
 - 4. 32

Q.7 The price of tea has decreased by 15%. By what percentage can a person increase the consumption of tea so that there is no change in the expenditure?

- Ans
- 1. $17\frac{11}{17}$
 - 2. $18\frac{7}{18}$
 - 3. $19\frac{7}{19}$
 - 4. $16\frac{11}{16}$

Q.8 If $a : b = 9 : 14$ and $b : c = 16 : 7$, then what is $a : b : c$?

- Ans
- 1. 9 : 112 : 7
 - 2. 72 : 102 : 49
 - 3. 9 : 112 : 49
 - 4. 72 : 112 : 49

Q.9 If A is the HCF of 78, 104, 338 and B is HCF of 136, 357, then the value of A + B is:

- Ans
- 1. 39
 - 2. 38
 - 3. 56
 - 4. 43

Q.10 In how much time will ₹800 amount to ₹926.10 at 10% per annum, compounded half-yearly?

- Ans
- 1. 2 years
 - 2. 1 year
 - 3. $1\frac{1}{2}$ years
 - 4. $2\frac{1}{2}$ years

Q.11 Ramesh is late by 9 minutes if he walks to school at a speed of 25 km/h. If he walks at a speed of 30 km/h, he arrives 9 minutes early. Find the distance between his house and school.

- Ans
- 1. 43 km
 - 2. 48 km
 - 3. 45 km
 - 4. 40 km

Q.12 Krisha alone takes 4 hours more to complete a job than if both Krisha and Krupa work together. If Krupa works alone, she takes 9 hours more to complete the job than if Krisha and Krupa worked together. What time would they take to complete the job if both Krisha and Krupa worked together?

- Ans
- 1. 8 hours
 - 2. 6 hours
 - 3. 7 hours
 - 4. 9 hours

Q.13 The length of a diagonal of a quadrilateral is 30 m and length of the perpendiculars from two vertices to the diagonal are 15 m and 25 m. Find the area of the quadrilateral.

- Ans
- 1. 600 m^2
 - 2. 300 m^2
 - 3. 325 m^2
 - 4. 250 m^2

Q.14 The percentage profit earned by selling an article for ₹1,800 is equal to the percentage loss incurred by selling the same article for ₹1,160. At what price should the article be sold to make a 20% profit?

- Ans
- 1. ₹1,776
 - 2. ₹1,550
 - 3. ₹1,480
 - 4. ₹1,650

Q.15 The simple interest on a certain sum of money at the rate of 5% p.a. for 9 years is ₹1,260. At what rate of interest can the same amount of interest be received on the same sum after 5 years?

- Ans
- 1. 8.6%
 - 2. 9%
 - 3. 11%
 - 4. 10%

Section : Computer Proficiency

Q.1 Which of the following is an example of a web browser?

- Ans
- 1. Mozilla Firefox
 - 2. Adobe Photoshop
 - 3. MS-Word
 - 4. Notepad

Q.2 In MS Excel 365, how we highlight an entire column?

- Ans**
- 1. By pressing 'Ctrl + Space bar'
 - 2. By pressing 'Ctrl + Enter'
 - 3. By pressing 'Ctrl + H'
 - 4. By pressing 'Ctrl + F'

Q.3 What does the 'Font Size' refer to in Microsoft Word 365?

- Ans**
- 1. The boldness of the text
 - 2. The size of the text characters
 - 3. The colour of the text
 - 4. The alignment of the text

Q.4 Which formatting option in MS-Word 365 allows you to slant or tilt the selected text to the right, commonly used for indicating emphasis or to differentiate titles from the main text?

- Ans**
- 1. Bold
 - 2. Italics
 - 3. Underline
 - 4. Text Colour

Q.5 In MS Word 365, Ctrl + E key is pressed to perform which of the following tasks?

- Ans**
- 1. Right Alignment
 - 2. Center Alignment
 - 3. Justify
 - 4. Left Alignment

Q.6 In MS Excel 365 which of the following charts is used in MS Excel when the category names are long or when comparing data across a time period?

- Ans**
- 1. Bar chart
 - 2. Column chart
 - 3. Pie chart
 - 4. Line chart

Q.7 What is the primary purpose of 'sorting and searching emails' when using email services?

- Ans**
- 1. Sending emails to multiple recipients simultaneously
 - 2. Changing the background colour of email messages
 - 3. Creating animated GIFs to embed in email content
 - 4. Organising emails based on various criteria for easy retrieval

Q.8 In Microsoft Excel 365, how can you sort data in ascending or descending order?

- Ans**
- 1. Data -> Form
 - 2. Data -> Sort
 - 3. Data -> Select
 - 4. Data -> Find

Q.9 Which of the following coloured wavy lines is used to represent spelling errors in an MS Word 365, document?

- Ans**
- 1. Black line
 - 2. Blue line
 - 3. Green line
 - 4. Red line

Q.10 Which of the following options in MS Word 365 means the page is oriented vertically?

- Ans
- 1. Landscape
 - 2. PageSet
 - 3. Page Setup
 - 4. Portrait



Prepare 50% Faster

Constable Executive Male and Female in Delhi Police Examination 2023

Exam Date	28/11/2023
Exam Time	3:00 PM - 4:30 PM
Subject	Constable Executive Male and Female in Delhi Police Examination 2023

Section : General Knowledge

Q.1 Which of the following constitutes a food chain starting from producer to top carnivores?

- Ans**
- 1. Small Plants → Insects → Fish → Birds → Tigers
 - 2. Insects → Frogs → Snakes → Vultures
 - 3. Soil → Grass → Deer → Tiger
 - 4. Grass → Insects → Snakes → Birds → Tigers

Q.2 चाणक्य की शिक्षा-दीक्षा _____ में हुई थी।

- Ans**
- 1. नालंदा
 - 2. तक्षशिला
 - 3. विक्रमशिला
 - 4. उज्जैन

Q.3 600 ईसा पूर्व - 600 ईस्वी की अवधि के दौरान निम्नलिखित में से कौन वह पहला शासक था, जिसने अपनी प्रजा और अधिकारियों के लिए अपने संदेशों को पत्थर की सतहों - प्राकृतिक चट्टानों के साथ-साथ पॉलिश किए गए स्तंभों पर अंकित किया था?

- Ans**
- 1. अजातसतु
 - 2. बिम्बिसार
 - 3. अशोक
 - 4. महापद्मनंद

Q.4 The Bidar Fort is located in which Indian state?

- Ans**
- 1. Maharashtra
 - 2. Andhra Pradesh
 - 3. Karnataka
 - 4. Rajasthan

Q.5 In karate, how many points are awarded for an 'Ippon'?

- Ans**
- 1. 3
 - 2. 2
 - 3. 4
 - 4. 1

Q.6 Which of the following is the first grand slam of the year?

- Ans**
- 1. Wimbledon
 - 2. French Open
 - 3. US Open
 - 4. Australian Open

Q.7 Under the Liberalisation Measure, the Monopolies and Restrictive Trade Practices (MRTP) Act 1969 was repealed of the following Acts?

- Ans
- 1. Competition Act 2002
 - 2. Foreign Exchange Management Act 1999
 - 3. Foreign Exchange Regulation Act 1973
 - 4. Industries Development and Regulation Act 1951

Q.8 The _____ is empowered to direct that an act of parliament does NOT apply to a scheduled area in the state.

- Ans
- 1. Governor
 - 2. Chief Minister
 - 3. High Court
 - 4. Supreme Court

Q.9 Which of the following industrial plants is supplied water from Bhadravati River?

- Ans
- 1. Rourkela Steel Plant
 - 2. Bokaro Steel Plant
 - 3. Visvesvaraya Iron and Steel Plant
 - 4. Durgapur Steel Plant

Q.10 संगीत नाटक अकादमी प्रख्यात कलाकारों को फेलोशिप देती है। राधा श्रीधर ने इसे भरतनाट्यम के लिए प्राप्त किया जो कि _____ राज्य का एक नृत्यरूप है।

- Ans
- 1. आंध्र प्रदेश
 - 2. कर्नाटक
 - 3. केरल
 - 4. तमिलनाडु

Q.11 स्वतंत्रता के बाद भारत की पहली जनगणना किस वर्ष आयोजित की गई थी?

- Ans
- 1. 1960
 - 2. 1954
 - 3. 1951
 - 4. 1958

Q.12 In general, what will happen with rainfall as we move from the equator to the poles?

- Ans
- 1. Rainfall goes on increasing steadily
 - 2. Rainfall is doubled
 - 3. Rainfall goes on decreasing steadily
 - 4. Rainfall remains constant

Q.13 निम्नलिखित में से किस चोल राजा ने गंगा घाटी क्षेत्र पर आक्रमण किया?

- Ans
- 1. अरिजय चोल
 - 2. गंदारादित्य
 - 3. राजेंद्र I
 - 4. उत्तम चोल

Q.14 दिल्ली सल्तनत के तहत कौन सा राजवंश भारत में पहला अफगान पश्तून राजवंश था?

- Ans
- 1. लोदी
 - 2. मामलुक
 - 3. खिलजी
 - 4. सैयद

Q.15 वाद्य-यंत्र और उससे जुड़े कलाकार के सही संयोजन की पहचान कीजिए।

- Ans
- 1. अली अकबर खान- तबला
 - 2. शिव कुमार शर्मा – संतूर
 - 3. ज़ाकिर हुसैन-सरोद
 - 4. बिसमिल्लाह खान-बाँसुरी

Q.16 द्विवार्षिक योजनाएँ कब लागू की गई थीं?

- Ans
- 1. छठी पंचवर्षीय योजना के बाद
 - 2. सातवीं पंचवर्षीय योजना के बाद
 - 3. नौवीं पंचवर्षीय योजना के बाद
 - 4. आठवीं पंचवर्षीय योजना के बाद

Q.17 लोकप्रिय उपन्यास पिंजर के लेखक कौन हैं?

- Ans
- 1. अमृता प्रीतम
 - 2. धर्मवीर भारती
 - 3. भीष्म साहनी
 - 4. यशपाल

Q.18 'पर ड्रॉप मोर क्रॉप (Per Drop More Crop)' किस सरकारी योजना की मुख्य टैग लाइन है?

- Ans
- 1. जलवायु परिवर्तन पर राष्ट्रीय कार्य योजना
 - 2. प्रधान मंत्री फसल बीमा योजना
 - 3. प्रधान मंत्री कृषि सिंचाई योजना
 - 4. अटल भूजल योजना

Q.19 सूची I का सूची II से मिलान करें।

सूची I

- a) क्षेत्रीय ग्रामीण बैंक
- b) नाबार्ड
- c) भारतीय स्टेट बैंक का राष्ट्रीयकरण

सूची II

- i) 1982
- ii) 1975
- iii) 1955

- Ans
- 1. a-i, b-ii, c-iii
 - 2. a-ii, b-i, c-iii
 - 3. a-iii, b-i, c-ii
 - 4. a-i, b-iii, c-ii

Q.20 The President of India and the Governor of States enjoy the immunities as mentioned under Article _____.

- Ans
- 1. 359
 - 2. 361
 - 3. 360
 - 4. 362

Q.21 Which of the following associations was established by Dr BR Ambedkar in 1930?

- Ans
- 1. Depressed Classes' Education Society
 - 2. Depressed Classes Association
 - 3. All India Harijan Sewak Sangh
 - 4. Satyashodhak Samaj

Q.22 According to a new definition of MSMEs 2020, medium enterprise turnover should NOT exceed how much amount

- Ans
- 1. ₹100 crore
 - 2. ₹150 crore
 - 3. ₹250 crore
 - 4. ₹200 crore

Q.23 निम्नलिखित में से कौन-सा उच्च न्यायालय 1866 में स्थापित किया गया था?

- Ans
- 1. गुजरात उच्च न्यायालय
 - 2. केरल उच्च न्यायालय
 - 3. बंबई उच्च न्यायालय
 - 4. इलाहाबाद उच्च न्यायालय

Q.24 In 1991, India met with an economic crisis due to _____.

- Ans
- 1. low inflation
 - 2. rise in foreign exchange reserves
 - 3. political instability
 - 4. huge debts burden

Q.25 When a carbon compound is burnt resulting in a clean flame, it indicates that it is:

- Ans
- 1. saturated hydrocarbon compounds
 - 2. sulphur containing compounds
 - 3. nitrogen containing compounds
 - 4. unsaturated hydrocarbon compounds

Q.26 चंपारण सत्याग्रह का नेतृत्व ब्रिटिश भारत के निम्नलिखित स्वतंत्रता सेनानियों में से किसके द्वारा किया गया था?

- Ans
- 1. राजेन्द्र प्रसाद
 - 2. महात्मा गांधी
 - 3. सुभाष चंद्र बोस
 - 4. लाल बहादुर शास्त्री

Q.27 निम्नलिखित में से अप्रत्यक्ष कर का उदाहरण कौन-सा है?

- Ans
- 1. सीमा शुल्क
 - 2. उपहार कर
 - 3. कॉर्पोरेट आय कर
 - 4. व्यक्तिगत आय कर

Q.28 Which of the following Amendment Acts laid down fundamental duties for Indian citizens?

- Ans
- 1. The 41st Amendment Act
 - 2. The 43rd Amendment Act
 - 3. The 42nd Amendment Act
 - 4. The 44th Amendment Act

Q.29 To which mineral group do galena, chalcopyrite and molybdenite belong?

- Ans
- 1. Sulphides
 - 2. Oxides
 - 3. Phosphides
 - 4. Halides

Q.30 आर.एल.वी. रामकृष्णन ने 2021 में मोहिनीअट्टम के लिए अकादमी पुरस्कार जीता। यह निम्नलिखित में से किस राज्य का शास्त्रीय नृत्य

- Ans
- 1. उड़ीसा
 - 2. असम
 - 3. केरल
 - 4. आंध्र प्रदेश

Q.31 'इंडिया विन्स फ्रीडम' निम्नलिखित स्वतंत्रता सेनानियों में से किसके द्वारा लिखी गई एक आत्मकथा है?

- Ans
- 1. एनी बेसेंट
 - 2. अबुल कलाम आज़ाद
 - 3. पट्टाभि सीतारमैया
 - 4. लोकमान्य तिलक

Q.32 Match column A with column B.

Column-A

- i. Producer
- ii. Primary consumer
- iii. Tertiary consumer
- iv. Decomposer

Column-B

- a. Carnivorous predators
- b. Green plants
- c. Bacteria
- d. Herbivorous animals

- Ans
- 1. i-b, ii-d, iii-a, iv-c
 - 2. i-a, ii-b, iii-c, iv-d
 - 3. i-b, ii-a, iii-d, iv-c
 - 4. i-b, ii-a, iii-c, iv-d

Q.33 Article 51 of the Indian Constitution says that the state shall endeavour to:

- Ans
- 1. protect monuments, places and objects of artistic or historic interest
 - 2. protect and improve the environment and to safeguard forests and wildlife
 - 3. separate judiciary from the executive
 - 4. promote international peace and security

Q.34 निम्नलिखित में से कौन-सी नदी मध्य प्रदेश में 'धुआंधार जलप्रपात' बनाती है?

- Ans
- 1. नर्मदा
 - 2. महानदी
 - 3. तापी
 - 4. गोदावरी

Q.35 गणतंत्र दिवस, 2023 के अवसर पर संस्कृति मंत्रालय द्वारा आयोजित कार्यक्रम "वंदे भारतम्" में कला के किस रूप का प्रदर्शन किया गया था?

- Ans
- 1. चित्रकारी
 - 2. संगीत
 - 3. नृत्य
 - 4. साहित्य

Q.36 थियोसोफिकल सोसायटी निम्नलिखित में से किस समाज सुधारक द्वारा शुरू की गई थी?

- Ans
- 1. सैय्यद अहमद खान
 - 2. स्वामी विवेकानंद
 - 3. एनी बेसेंट
 - 4. राजा राम मोहन राय

Q.37 पूर्णमासी जानी एक आदिवासी गायिका और सामाजिक कार्यकर्ता हैं, जिन्होंने सामाजिक उद्देश्यों को बढ़ावा देने वाले हजारों गाने गाए हैं।

- Ans
- 1. कुमाऊँनी
 - 2. मारवाड़ी
 - 3. बोडो
 - 4. उड़िया

Q.38 Read the given statements and select the most appropriate option.
i) A white blood cell (WBC) in human blood can change its shape.
ii) The shape of amoeba appears irregular.

- Ans
- 1. Both statements are correct.
 - 2. Only statement one is correct.
 - 3. Only statement two is correct.
 - 4. Both statements are incorrect.

Q.39 निम्नलिखित में से वह स्थिति कौन-सी है, जिसमें वास्तव में आवश्यकता से अधिक लोग कार्य में लगे हुए होते हैं?

- Ans
- 1. प्रच्छन्न बेरोजगारी (Disguised unemployment)
 - 2. मौसमी बेरोजगारी (seasonal unemployment)
 - 3. संघर्षात्मक बेरोजगारी (Frictional unemployment)
 - 4. प्रकट बेरोजगारी (Open unemployment)

Q.40 भारत में गणतंत्र दिवस की परेड की अध्यक्षता _____ करते हैं।

- Ans
- 1. भारत के राष्ट्रपति
 - 2. भारत के प्रधान मंत्री
 - 3. भारत के उपराष्ट्रपति
 - 4. रक्षा प्रमुख (चीफ ऑफ डिफेंस)

Q.41 निम्नलिखित में से कौन सा नृत्य उत्तर भारत की रास लीला से प्रभावित था?

- Ans
- 1. भरतनाट्यम
 - 2. कुचिपुड़ी
 - 3. ओडिसी
 - 4. कथक

Q.42 Under which of the following Acts were the commercial activities to be taken care by the East India Company and the political activities by the British parliament?

- Ans
- 1. Indian Councils Act of 1861
 - 2. Pitts India Act, 1784
 - 3. Regulating Act of 1773
 - 4. Government of India Act of 1935

Q.43 प्रधानमंत्री गरीब कल्याण जमा योजना (PMGKDS) भारत सरकार द्वारा किस वर्ष शुरू की गई थी?

- Ans
- 1. 2009 में
 - 2. 2020 में
 - 3. 2014 में
 - 4. 2016 में

Q.44 23वें राष्ट्रमंडल खेलों की मेजबानी _____ के द्वारा की जाएगी।

- Ans
- 1. कनाडा
 - 2. इंग्लैंड
 - 3. ऑस्ट्रेलिया
 - 4. भारत

Q.45 न्यू मंगलौर बंदरगाह किस राज्य में स्थित है?

- Ans
- ✓ 1. कर्नाटक
 - ✗ 2. गोवा
 - ✗ 3. तमिलनाडु
 - ✗ 4. केरल

Q.46 क्रिकेट गेंद की परिधि लगभग कितनी होती है?

- Ans
- ✗ 1. लगभग 6 इंच
 - ✗ 2. लगभग 5 इंच
 - ✓ 3. लगभग 9 इंच
 - ✗ 4. लगभग 12 इंच

Q.47 भारत के संविधान के अनुच्छेद 21 A के तहत बच्चों को मुफ्त और अनिवार्य शिक्षा प्रदान करने की आयु क्या है?

- Ans
- ✗ 1. दस से चौदह वर्ष
 - ✓ 2. छह से चौदह वर्ष
 - ✗ 3. आठ से बारह वर्ष
 - ✗ 4. आठ से चौदह वर्ष

Q.48 अध्यक्ष (Speaker) और उपाध्यक्ष (Deputy Speaker) की अनुपस्थिति में लोकसभा की अध्यक्षता कौन करता है?

- Ans
- ✗ 1. प्रधानमंत्री द्वारा नियुक्त व्यक्ति
 - ✓ 2. अध्यक्ष द्वारा मनोनीत पैनल के सदस्यों में से कोई व्यक्ति
 - ✗ 3. सर्वोच्च न्यायालय के मुख्य न्यायाधीश
 - ✗ 4. राष्ट्रपति

Q.49 Which of the following temples is located at the centre point of the world's magnetic equator?

- Ans
- ✓ 1. Chidambaram Temple
 - ✗ 2. Meenakshi Temple
 - ✗ 3. Srirangam Temple
 - ✗ 4. Kailasanathar Temple

Q.50 शंकरदेव ने किस धर्म के प्रचार के लिए असम में सत्रिया नृत्य की शुरुआत की थी?

- Ans
- ✗ 1. बुद्ध धर्म
 - ✗ 2. जैन धर्म
 - ✗ 3. शैव धर्म
 - ✓ 4. वैष्णव धर्म

Section : Reasoning

Q.1 दिए गए कथनों और निष्कर्षों को ध्यानपूर्वक पढ़ें। यह मानते हुए कि कथनों में दी गई जानकारी सही है, भले ही वह सामान्य रूप से ज्ञात तथ्यों से भिन्न लगे, निर्णय करें कि कौन-सा/से निष्कर्ष दिए गए कथनों का तार्किक रूप से अनुसरण करता है/करते हैं।

कथन:

सभी आम, अंगूर हैं।

सभी अंगूर, अमरूद हैं।

निष्कर्ष:

I. कुछ अमरूद, आम हैं।

II. सभी आम, अमरूद हैं।

- Ans
- ✗ 1. केवल निष्कर्ष II अनुसरण करता है।
 - ✓ 2. निष्कर्ष I और II दोनों अनुसरण करते हैं।
 - ✗ 3. निष्कर्ष I और II में से कोई भी अनुसरण नहीं करता है।
 - ✗ 4. केवल निष्कर्ष I अनुसरण करता है।

Q.2 दिए गए चार विकल्पों में से उस आकृति का चयन करें, जिसे आकृति (X) के रिक्त स्थान में रखने पर यह प्रतिरूप पूरा हो जाएगा।

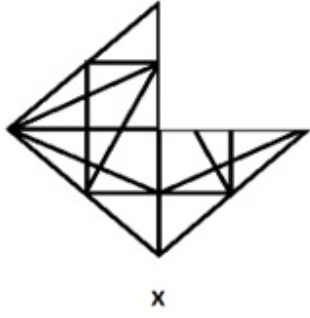

Ans

- 1.
- 2.
- 3.
- 4.

Q.3 एक निश्चित कूट भाषा में, 'TIDE' को 'EDJS' के रूप में लिखा जाता है और 'MARS' को 'BLSR' के रूप में लिखा जाता है। उसी भाषा में 'HOPE' को कैसे लिखा जाएगा?

- 1. PEHO
- 2. FGPO
- 3. FIQP
- 4. EPFG

Prepare 50% Faster

Q.4 उस आकृति का चयन कीजिए, जो निम्नलिखित आकृति श्रृंखला में आगे आएगी।

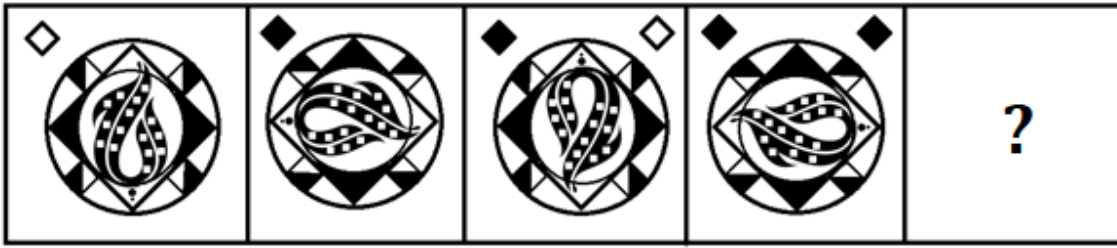

Ans

✗ 1.



✗ 2.



✓ 3.



✗ 4.



Q.5 निम्नलिखित में से कौन-सा विकल्प दी गई श्रृंखला में प्रश्नवाचक चिन्ह (?) को प्रतिस्थापित करेगा?
150, 230, 322, 402, ?, 574

Ans ✗ 1. 488

✓ 2. 494

✗ 3. 477

✗ 4. 459

Q.6 सात बच्चे - T, U, V, W, X, Y और Z - एक सीधी पंक्ति में उत्तर की ओर मुख करके बैठे हैं। U, Z के बाएं दूसरे स्थान पर बैठा है। Y, T के बाएं तीसरे स्थान पर बैठा है। X के दाएं केवल एक बच्चा बैठा है। W के बाएं केवल दो बच्चे बैठे हैं। निम्नलिखित में से कौन-सा बच्चा पंक्ति के बाएं सिरे पर बैठा है?

Ans ✗ 1. T

✗ 2. U

✓ 3. Y

✗ 4. V

Q.7 दी गई आकृति की सही दर्पण छवि का चयन कीजिए जब दर्पण को दर्शाए गए तरीके से 'AB' पर रखा जाता है।

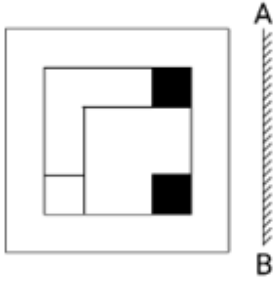

Ans

✗ 1.

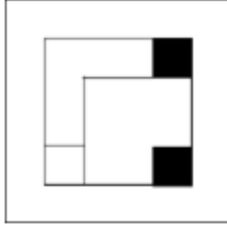

✓ 2.

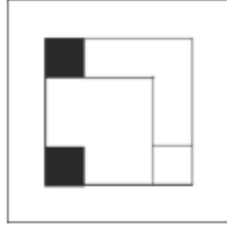

✗ 3.



✗ 4.

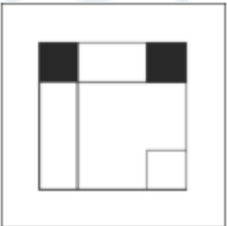

Q.8 उस विकल्प का चयन करें, जो पाँचवें अक्षर-समूह से उसी प्रकार संबंधित है, जिस प्रकार दूसरा अक्षर-समूह पहले अक्षर-समूह से संबंधित है और चौथा अक्षर-समूह तीसरे अक्षर-समूह से संबंधित है।
LOVE : BSLI :: WORK : HOLT :: SORT : ?

Ans ✓ 1. QOLP

✗ 2. QOLR

✗ 3. ROLQ

✗ 4. QOMP

Q.9 उस विकल्प आकृति का चयन करें, जिसमें दी गई आकृति सन्नहित है।
(घुमाने की अनुमति नहीं है)

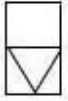

Ans

✓ 1.

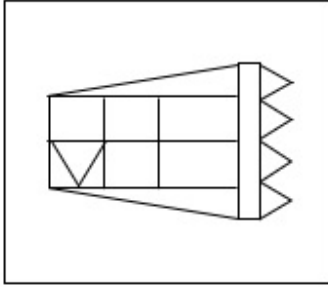

✗ 2.

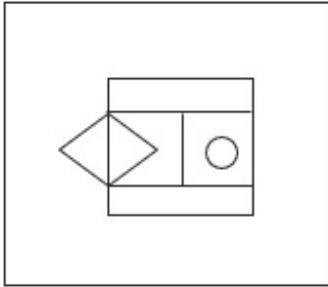

✗ 3.

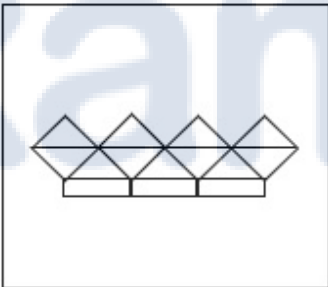

✗ 4.

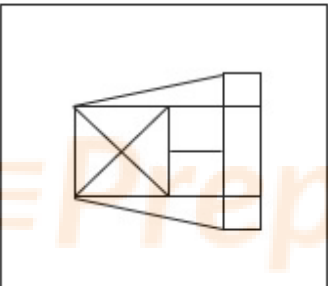

Q.10 दिए गए विकल्पों में से उस आकृति का चयन करें जो निम्नलिखित श्रृंखला में

प्रश्नवाचक चिह्न (?) का स्थान ले सकती है।

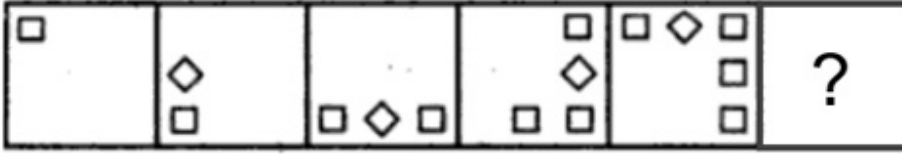

Ans

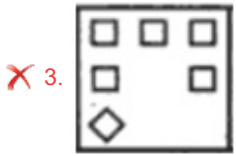
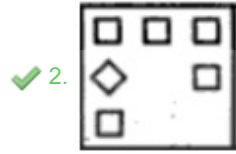
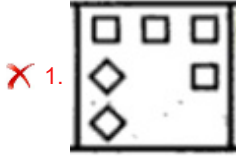

Q.11 उस समुच्चय का चयन करें जिसमें संख्याएँ उसी प्रकार संबंधित हैं जिस प्रकार निम्नलिखित समुच्चयों की संख्याएँ संबंधित हैं।

(नोट: संख्याओं को उनके घटक अंकों में विभाजित किए बिना, पूर्ण संख्याओं पर गणितीय संक्रियाएँ की जानी चाहिए। उदाहरण के लिए 13 के मामले में - गणितीय संक्रियाएँ जैसे कि 13 में जोड़ना/घटाना/गुणा करना आदि केवल 13 पर की जा सकती हैं। 13 को 1 और 3 में विभाजित करने और फिर 1 और 3 पर गणितीय संक्रियाएँ करने की अनुमति नहीं है।)

(63, 9, 27)
(105, 15, 45)

Ans ✗ 1. (147, 21, 65)

✗ 2. (149, 21, 63)

✓ 3. (147, 21, 63)

✗ 4. (149, 21, 65)

Q.12 दिए गए विकल्पों में से उस पासे का चयन करें, जो दी गई कागज की शीट (X) से बने पासे के समान है।

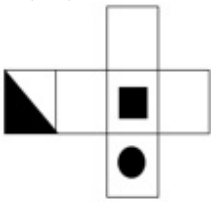

(X)

Ans

1.



2.



3.



4.



Q.13 गणितीय चिह्नों के ऐसे सही संयोजन का चयन कीजिए, जो यथाक्रम चिह्नों (*) को प्रतिस्थापित कर प्रस्तुत समीकरण को संतुलित करे।
 $17 * 17 * 50 * 28 * 7 * 243$

Ans

1. $\times, -, +, \div, =$

2. $\times, +, -, \div, =$

3. $-, +, \times, \div, =$

4. $\div, +, -, \times, =$

Prepare 50% Faster

Q.14 दर्पण को नीचे चित्र के अनुसार 'MN' पर रखे जाने पर दिए गए संयोजन के सही दर्पण प्रतिबिंब का चयन करें।

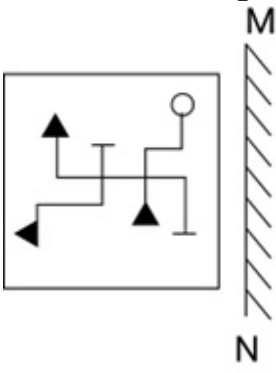

Ans

✗ 1.

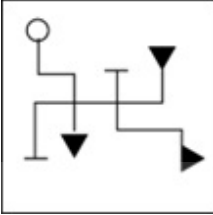

✓ 2.

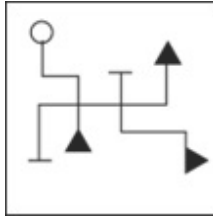

✗ 3.

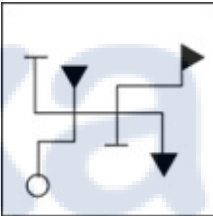

✗ 4.

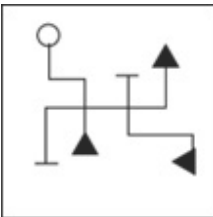

Q.15 एक पासे के अलग-अलग फलकों पर छह अक्षर A, B, C, P, Q और R लिखे गए हैं। इस पासे की दो स्थितियां दी गई आकृति में दिखाई गई हैं। B अक्षर वाले फलक के विपरीत फलक पर कौन-सा अक्षर है?

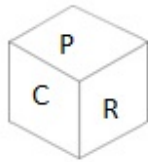
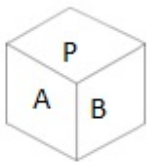

Ans

✓ 1. R

✗ 2. Q

✗ 3. C

✗ 4. A

Q.16

निम्नलिखित श्रृंखला को जारी रखने के लिए प्रश्न चिह्न (?) के स्थान पर कौन सी आकृति आनी चाहिए?

O	L	L	↑	L	↑	↑	D	↑	D	
	↑		O		D		L		Z	?
D		Z	D	Z	Z	O	Z	O	O	L

Ans

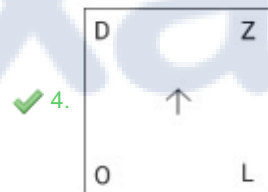
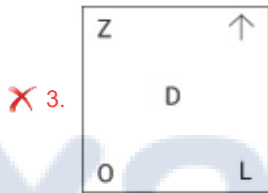
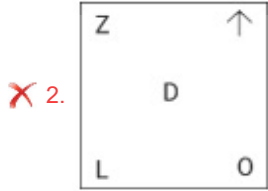
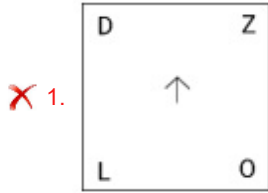

Q.17 गणितीय चिह्नों के उस सही संयोजन का चयन करें, जिन्हें दिए गए समीकरण में * चिह्नों के स्थान पर क्रमिक रूप से रखे जाने पर समीकरण संतुलित हो जाएगा।

$$53 * 19 * 8 * 32 * 4 * 197$$

Ans ✗ 1. +, +, x, -, =

✓ 2. +, x, -, +, =

✗ 3. x, +, -, +, =

✗ 4. +, -, x, +, =

Q.18 दी गई आकृति में कितने अर्धवृत्त हैं?

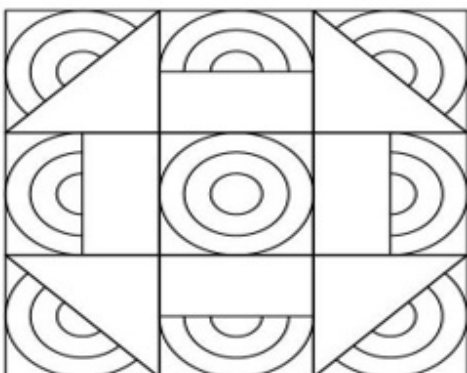

Ans ✗ 1. 27

✗ 2. 33

✓ 3. 30

4. 24

Q.19 एक पासे के अलग - अलग फलकों पर छह अक्षर A, B, C, D, E और F लिखे गए हैं। इस पासे की दो स्थितियाँ दी गई आकृति में दिखाई हैं। अक्षर वाले फलक के विपरीत फलक पर अक्षर ज्ञात कीजिए। ixamBee Prepare 50% Faster

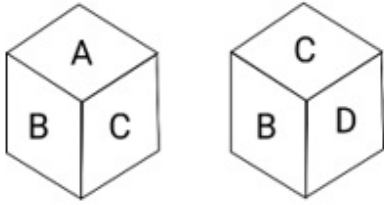

- Ans
- 1. A
 - 2. F
 - 3. B
 - 4. E

Q.20 उस विकल्प का चयन करें जो तीसरे पद से उसी प्रकार संबंधित है जिस प्रकार दूसरा पद पहले पद से और छठा पद पांचवें पद से संबंधित है।
 $24 : 566 :: 12 : ? :: 8 : 54$

- Ans
- 1. 154
 - 2. 134
 - 3. 120
 - 4. 124

Q.21 एक कागज को नीचे दिखाए अनुसार मोड़ा और काटा जाता है। खोलने पर यह कैसा दिखाई देगा?

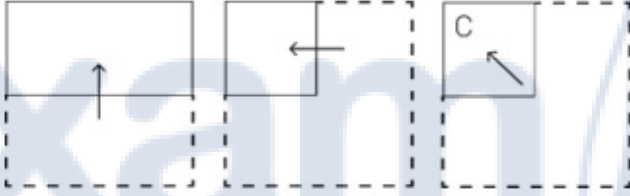

- Ans
- 1.
 - 2.
 - 3.
 - 4.

Q.22 निम्नलिखित में से कौन सा पद (अक्षर-समूह) दी गई श्रृंखला में प्रश्न चिह्न (?) के स्थान पर आएगा?
 GSJV, IQLT, KONR, ?, OKRN

- Ans
- 1. MMPP
 - 2. NMOP
 - 3. MNPO
 - 4. LMPO

Q.23 दर्पण को नीचे दिए गए चित्र के अनुसार PQ पर रखे जाने पर दी गई आकृति का दर्पण में निर्मित सही प्रतिबिंब चयनित कीजिए।

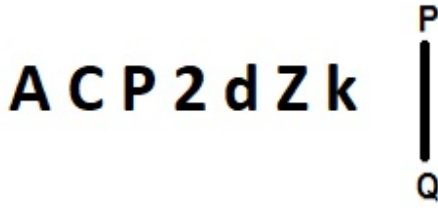

- Ans
- ✗ 1. k Z p S P C A
 - ✗ 2. A C P 2 d Z k
 - ✓ 3. k Z p S P C A
 - ✗ 4. k Z p S P C A

Q.24 जब दर्पण को निम्न चित्र के अनुसार 'AB' पर रखा जाता है, तो दिए गए पैटर्न का सही दर्पण प्रतिबिम्ब चुनें।

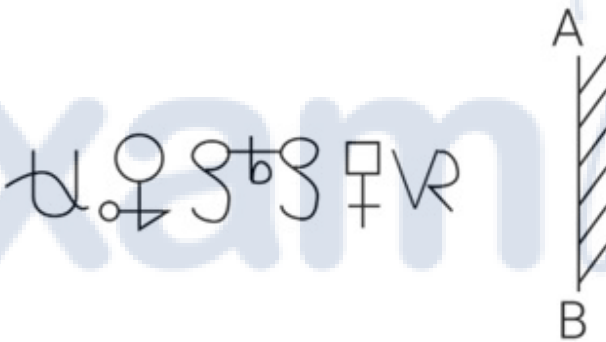

- Ans
- ✗ 1. Square with vertical line, Circle with vertical line, Square with vertical line, Circle with vertical line, Square with vertical line, Circle with vertical line
 - ✗ 2. Square with vertical line, Circle with vertical line, Square with vertical line, Circle with vertical line, Square with vertical line, Circle with vertical line
 - ✗ 3. Circle with vertical line, Square with vertical line, Circle with vertical line, Square with vertical line, Circle with vertical line, Square with vertical line
 - ✓ 4. Square with vertical line, Circle with vertical line, Square with vertical line, Circle with vertical line, Square with vertical line, Circle with vertical line

Q.25 कागज की एक वर्गाकार शीट को बिंदीदार रेखा के अनुदिश दिखाए गए निर्देशों के अनुसार क्रमिक रूप से मोड़ा जाता है और फिर अंत छिद्रित किया जाता है। कागज को खोलने पर यह कैसा दिखेगा?

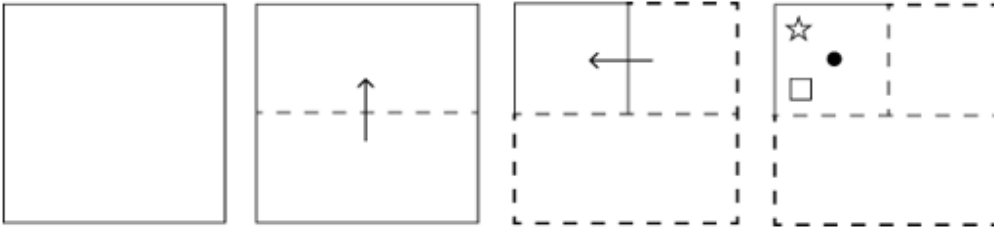

Ans

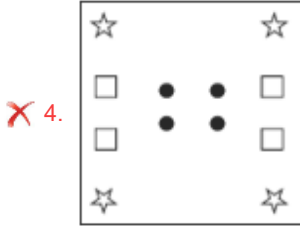
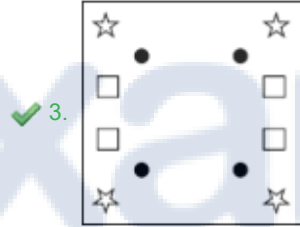
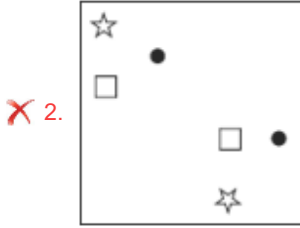
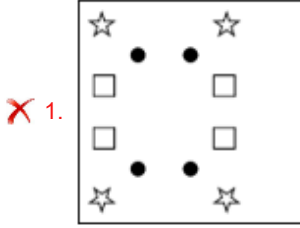

Section : Numerical Ability

Q.1 200 पुरुषों के पास 30 दिनों का खाद्य पदार्थ है। यदि इनमें से 50 पुरुष चले जाते हैं, तो शेष पुरुषों के लिए वही खाद्य पदार्थ कितने दिनों तक चलेगा?

- Ans
- ✗ 1. 24 दिन
 - ✓ 2. 40 दिन
 - ✗ 3. 28 दिन
 - ✗ 4. 32 दिन

Q.2 यदि एक गोले का आयतन और पृष्ठीय क्षेत्रफल संख्यात्मकतः समान है, तो इसकी त्रिज्या ज्ञात करें।

- Ans
- ✓ 1. 3 इकाई
 - ✗ 2. 4 इकाई
 - ✗ 3. 1 इकाई
 - ✗ 4. 2 इकाई

Q.3 ₹7,500 की धनराशि के लिए, ब्याज दर 7.5% वार्षिक साधारण ब्याज है। 4 वर्ष 9 महीने में अर्जित ब्याज ज्ञात कीजिए।

- Ans
- ✗ 1. ₹2,761.875
 - ✗ 2. ₹2,871
 - ✓ 3. ₹2,617.875
 - ✗ 4. ₹2,671.875

Q.4 यदि 5 cm त्रिज्या वाले एक बड़े ठोस गोले से 125 समान छोटे ठोस गोले बनाए जाते हैं, तो प्रत्येक छोटे गोले का पृष्ठीय क्षेत्रफल (cm^2 में)

- Ans
- 1. 8π
 - 2. 12π
 - 3. 25π
 - 4. 4π

Q.5 ₹50,000 पर 8% प्रति वर्ष की दर से चक्रवृद्धि ब्याज ₹8,320 है। अवधि ज्ञात कीजिए।

- Ans
- 1. 4 वर्ष
 - 2. 3 वर्ष
 - 3. 2 वर्ष
 - 4. 5 वर्ष

Q.6 एक स्कूल में लड़कों की संख्या का लड़कियों की संख्या से अनुपात 7 : 9 है। यदि स्कूल में 1183 लड़के हैं, तो उस स्कूल में लड़कों और लड़कियों की कुल संख्या कितनी है?

- Ans
- 1. 2720
 - 2. 2736
 - 3. 2704
 - 4. 2688

Q.7 22 से 30 तक (दोनों को सम्मिलित करते हुए) की सभी सम संख्याओं का औसत ज्ञात कीजिए।

- Ans
- 1. 25.5
 - 2. 26.0
 - 3. 25.0
 - 4. 24.5

Q.8 यदि $\frac{b}{a} = 0.75$ हो, तो $\frac{2a-b}{2a+b} + \frac{8}{9}$ का मान क्या होगा?

- Ans
- 1. $\frac{19}{111}$
 - 2. $\frac{133}{99}$
 - 3. $\frac{17}{99}$
 - 4. $\frac{13}{9}$

Q.9 एक आदमी अपनी यात्रा 6 घंटे में पूरी करता है। वह आधी दूरी 30 Km/h की चाल से और शेष 50 Km/h की चाल से तय करता है। यात्रा की लंबाई (Km में) कितनी है?

- Ans
- 1. 125
 - 2. 225
 - 3. 252
 - 4. 112.5

Q.10 एक वस्तु को एक निश्चित कीमत पर बेचने पर एक महिला को 20% का लाभ होता है। यदि वह इसे दोगुनी कीमत पर बेचती है, तो अर्जि गणना करें।

- Ans
- 1. 130%
 - 2. 140%
 - 3. 120%
 - 4. 110%

Q.11 एक अलमारी को 20% की छूट देने के बाद ₹6,500 में बेचा जाता है। इसका अंकित मूल्य (₹ में) ज्ञात करें।

- Ans
- 1. 8,125
 - 2. 8,235
 - 3. 7,546
 - 4. 8,000

Q.12 यदि $\frac{52416}{168} = 312$ है, तो $\frac{52.416}{0.0168}$ का मान _____ है।

- Ans
- 1. 31.2
 - 2. 312
 - 3. 3120
 - 4. 3.12

Q.13 लुकास की मासिक आय ₹42,500 है। यदि उसकी आय में 18% की वृद्धि होती है, तो उसकी नई मासिक आय (₹ में) ज्ञात कीजिए।

- Ans
- 1. 47,500
 - 2. 48,120
 - 3. 50,150
 - 4. 43,000

Q.14 दो उम्मीदवारों के बीच हुए एक चुनाव में, 10% मतदाताओं ने मतदान में भाग नहीं लिया, 20% मतों को अवैध घोषित कर दिया गया और विजेता को कुल वैध मतों के 70% मत प्राप्त हुए तथा उसने 6480 मतों से जीत दर्ज की। मतदान सूची में मतों की कुल संख्या ज्ञात कीजिए।

- Ans
- 1. 28,400
 - 2. 22,500
 - 3. 26,700
 - 4. 25,600

Q.15 $2.5 \times (4 - (2^4 - 3^3) \div (\frac{11}{4})) \div 8 \times (\frac{4}{3})$ का सरलीकृत मान _____ है।

- Ans
- 1. $\frac{8}{3}$
 - 2. $\frac{10}{3}$
 - 3. $\frac{4}{3}$
 - 4. $-\frac{2}{3}$

Q.1 In MS Excel 365, which Microsoft Excel view allows you to see how the printed worksheet will look before actually printing it?

- Ans
- 1. Normal view
 - 2. Page Layout view
 - 3. Full Screen view
 - 4. Print Preview

Q.2 What does the Uniform Resource Locator (URL) specify?

- Ans
- 1. ISP
 - 2. Internet protocol
 - 3. HTML
 - 4. Unique address assigned to each web resource

Q.3 एमएस-वर्ड 365 (MS-Word 365) में चयनित टेक्स्ट को कट करने के लिए निम्नलिखित में से किस कीबोर्ड शॉर्टकट कुंजी (key) का उपयोग किया जाता है?

- Ans
- 1. Ctrl + c
 - 2. Ctrl + v
 - 3. Ctrl + p
 - 4. Ctrl + x

Q.4 In MS Excel 365 which of the following is an example of absolute reference pointing to cell A1 in MS Excel?

- Ans
- 1. @A1
 - 2. 1A
 - 3. A1
 - 4. \$A\$1

Q.5 Which of the following options allows you to choose whether to keep or discard the formatting of pasted text in MS Word 365?

- Ans
- 1. Format Painter
 - 2. Font Selection
 - 3. Cut and Paste
 - 4. Paste Special

Q.6 Which of the following windows is used when we want to write an email in Gmail?

- Ans
- 1. Send
 - 2. Spam
 - 3. Compose
 - 4. Draft

Q.7 In MS-Word 365, which action allows you to duplicate selected text and place a copy of it on the clipboard?

- Ans
- 1. Cut
 - 2. Paste
 - 3. Copy
 - 4. Select All

Q.8 In MS Word 365 Which of the following best describes the use of justify text?

- Ans
- 1. To align evenly along left margins
 - 2. To align evenly along right margins
 - 3. To align evenly along left and right margins
 - 4. To center the text

Q.9 In MS Excel 365, which of the following is the correct option to open an existing spread sheet in MS-Excel?

- Ans**
- 1. Click on File tab<<Click on New
 - 2. Click on File tab<<Click on Open
 - 3. Click on Home tab<<Click on New
 - 4. Click on Home tab<<Click on Open

Q.10 Which of the following is the default font when a new blank document is created in MS Word 365?

- Ans**
- 1. Calibri
 - 2. Arial
 - 3. Cambria
 - 4. Times New Roman



Prepare 50% Faster

Constable Executive Male and Female in Delhi Police Examination 2023

Exam Date	29/11/2023
Exam Time	9:00 AM - 10:30 AM
Subject	Constable Executive Male and Female in Delhi Police Examination 2023

Section : General Knowledge

Q.1 Under which Act was the legislative powers of making and amending laws restored to the provinces?

- Ans**
- 1. Indian Council Act, 1909
 - 2. Indian Council Act, 1892
 - 3. Indian Council Act, 1861
 - 4. Regulating Act, 1773

Q.2 Which of the following dams was NOT funded during the First Five-Year Plan for development of irrigation facility?

- Ans**
- 1. Hirakund dam
 - 2. Gosi Khurd dam
 - 3. Mettur dam
 - 4. Bhakra Nangal dam

Q.3 Abdel Fattah al-Sisi, the Chief Guest of the Republic Day 2023 celebration in Delhi, is associated with which country?

- Ans**
- 1. Egypt
 - 2. Syria
 - 3. Israel
 - 4. Bahrain

Q.4 In which year did India win its first Olympic gold in hockey?

- Ans**
- 1. 1928
 - 2. 1960
 - 3. 1922
 - 4. 1956

Q.5 Which component of the cytoskeleton are rigid hollow rods, about 25 nm in diameter, that play an important role in the cell cycle by forming the mitotic spindle?

- Ans**
- 1. Actin filaments
 - 2. Intermediate filaments
 - 3. Microtubules
 - 4. Microfibers

Q.6 The term 'chui' in judo means _____.

- Ans**
- 1. light penalty
 - 2. throwing technique
 - 3. warning
 - 4. holding technique

Q.7 Which of the following censuses recorded the highest gap in male and female literacy rates in India?

- Ans
- 1. 1971
 - 2. 1981
 - 3. 2001
 - 4. 1991

Q.8 Which festival is also known as the foundation day of Khalsa Panth?

- Ans
- 1. Baisakhi
 - 2. Gurupurab
 - 3. Lohri
 - 4. Basant Panchami

Q.9 The Nalanda University was built in _____.

- Ans
- 1. Kuru
 - 2. Matsya
 - 3. Vatsa
 - 4. Magadha

Q.10 The Indira Sagar Multipurpose Project is located in which state?

- Ans
- 1. Rajasthan
 - 2. Madhya Pradesh
 - 3. Himachal Pradesh
 - 4. Tamil Nadu

Q.11 Which Mughal emperor is known for designing a series of inlays behind his throne in the court at Delhi that depicted the legendary Greek god Orpheus playing the lute?

- Ans
- 1. Babur
 - 2. Akbar
 - 3. Shah Jahan
 - 4. Humayun

Q.12 In 1991, India met with an economic crisis due to _____.

- Ans
- 1. political instability
 - 2. low inflation
 - 3. huge debts burden
 - 4. the rise in foreign exchange reserves

Q.13 Which of the following deities was known as breaker of forts in the Rig Veda?

- Ans
- 1. Marut
 - 2. Agni
 - 3. Varuna
 - 4. Indra

Q.14 The chemical name of Plaster of Paris is _____.

- Ans
- 1. calcium sulphate semihydrate
 - 2. calcium sulphate hemihydrate
 - 3. calcium hydrogen semihydrate
 - 4. calcium hydrogen hemihydrate

Q.15 Which of the following is the correct match of the column-A with column-B?

Column-A (Adulterant)

- i. Papaya seed
- ii. Argemone seed
- iii. Detergent
- iv. Yellow aniline dye

Column-B (Food Material)

- a. Turmeric
- b. Milk
- c. Mustard oil
- d. Black pepper

- Ans
- 1. i-c, ii-a, iii-b, iv-d
 - 2. i-c, ii-d, iii-b, iv-a
 - 3. i-d, ii-c, iii-b, iv-a
 - 4. i-c, ii-d, iii-a, iv-b

Q.16 How many medals did India win in the Commonwealth Games-2022?

- Ans
- 1. 59
 - 2. 57
 - 3. 58
 - 4. 61

Q.17 Which Article of the Indian Constitution mentions that it shall be the duty of every citizen of India to develop scientific temper?

- Ans
- 1. 51 A (h)
 - 2. 51 A (j)
 - 3. 51 A (k)
 - 4. 51 A (i)

Q.18 Read the given statements and select the correct option regarding 'High Powered Money'.
(i) High Powered Money consists of currency and cash reserves with the bank.
(ii) High Powered Money includes demand deposits of the banks.

- Ans
- 1. Only (i) is true
 - 2. Only (ii) is true
 - 3. Both (i) and (ii) are true
 - 4. Both (i) and (ii) are false

Q.19 _____ refers to the measure related to the sale of assets for the achievement of some purpose.

- Ans
- 1. Total denationalisation
 - 2. Management buyout
 - 3. Liquidation
 - 4. Joint venture

Q.20 Annatto seeds and extract is used as adulterant in:

- Ans
- 1. rice powder
 - 2. dairy products
 - 3. wheat flour
 - 4. turmeric powder

Q.21 Which part of the Constitution of India states that the citizen has to defend the country and render national service when called upon to do so?

- Ans
- 1. Part II A
 - 2. Part IV A
 - 3. Part III A
 - 4. Part V A

Q.22 Identify the Navratna of Akbar's court who played a pivotal role in the development of the classical genre of Hind music.

- Ans
- 1. Amir Khusro
 - 2. Tansen
 - 3. Swami Haridas
 - 4. Mirabai

Q.23 Dr. Karni Singh Shooting Range is located at:

- Ans
- 1. New Delhi
 - 2. Bangalore
 - 3. Jaipur
 - 4. Mumbai

Q.24 From which of the following cities did the Revolt of 1857 begin on 10 May 1857 in British India?

- Ans
- 1. Delhi
 - 2. Jhansi
 - 3. Kanpur
 - 4. Meerut

Q.25 Buddhist texts called Dipavamsa and Mahavamsa, which are the sources of information to Mauryan times, belong to which of the following countries?

- Ans
- 1. Myanmar
 - 2. Sri Lanka
 - 3. India
 - 4. China

Q.26 Mount Fuji, the highest mountain in Japan, which is made of felsic to intermediate rock, represents which type of volcanoes?

- Ans
- 1. Shield
 - 2. Fissure
 - 3. Composite
 - 4. Cinder cone

Q.27 In which of the following years was the Vernacular Press Act passed?

- Ans
- 1. 1859
 - 2. 1878
 - 3. 1919
 - 4. 1902

Q.28 'Roads to Mussoorie', the famous novel is written by whom among the following Sahitya Akademi Awardee?

- Ans
- 1. Shobha Dey
 - 2. Ruskin Bond
 - 3. Mulk Raj Anand
 - 4. R K Narayan

Q.29 Whose song 'Shaabaash' became the anthem of Indian athletes at the Commonwealth Games 2022?

- Ans
- 1. Nilotpal Bora
 - 2. Zubeen Garg
 - 3. Jayanta Nath
 - 4. Jim Ankan Deka

Q.30 Who among the following founded the Ramakrishna Mission in 1897?

- Ans
- 1. Swami Vivekananda
 - 2. Sri Ramakrishna Paramhansa
 - 3. Sri Aurobindo
 - 4. Raja Ram Mohan Roy

Q.31 Under which of the following Articles can a person directly approach the Supreme Court for the enforcement of his Fundamental Rights?

- Ans
- 1. Article 31
 - 2. Article 34
 - 3. Article 33
 - 4. Article 32

Q.32 Which of the following powers is NOT enjoyed by the Governor of a State?

- Ans
- 1. Diplomatic/Military powers
 - 2. Legislative powers
 - 3. Judiciary powers
 - 4. Executive powers

Q.33 According to the census of India 2011, what is the female literacy rate in Dadra and Nagar Haveli?

- Ans
- 1. 64.32%
 - 2. 61.12%
 - 3. 68.43%
 - 4. 76.48%

Q.34 In the year 1855, the first jute mill was set up at Rishra, which is located in:

- Ans
- 1. Odisha
 - 2. Andhra Pradesh
 - 3. West Bengal
 - 4. Bihar

Q.35 Who among the following said that Raziyya was more able and /qualified than all her brothers for the Sultan of Delhi Sultanate?

- Ans
- 1. Abdul Malik Isami
 - 2. Ahmad Yadgar
 - 3. Qutb ud-Din Aibak
 - 4. Minhaj-i Siraj

Q.36 Which of the following layers is important for living things?

- Ans
- 1. Troposphere
 - 2. Mesosphere
 - 3. Stratosphere
 - 4. Exosphere

Q.37 Who was the President of India between the years 1987 and 1992?

- Ans
- 1. Shankar Dayal Sharma
 - 2. Fakhruddin Ali Ahmed
 - 3. Giani Zail Singh
 - 4. R Venkataraman

Q.38 During the Fourth Five-Year Plan, the process of nationalisation of banks took place. How many banks were nationalised during this period?

- Ans**
- 1. 6
 - 2. 14
 - 3. 20
 - 4. 10

Q.39 What is the tenure of the President of India?

- Ans**
- 1. 10 years
 - 2. 6 years
 - 3. 5 years
 - 4. 2 years

Q.40 Which of the following is the international partner in the implementation of 'PM Grameen Digital Saksharta Abhiyan'?

- Ans**
- 1. UNDP
 - 2. UNICEF
 - 3. World Bank
 - 4. UNESCO

Q.41 _____ wrote a three-volume history of Akbar's reign, titled 'Akbar Nama'.

- Ans**
- 1. Faizi
 - 2. Humayun
 - 3. Abul Fazi
 - 4. Bahadur Shah II

Q.42 Guru Bipin Singh was conferred the Kalidas Samman Award for which form of dance?

- Ans**
- 1. Manipuri
 - 2. Odissi
 - 3. Kuchipudi
 - 4. Kathakali

Q.43 According to the census of India 2011, select the Union Territory that had less than 1 lakh population?

- Ans**
- 1. Dadra and Nagar Haveli
 - 2. Daman and Diu
 - 3. Lakshadweep
 - 4. Puducherry

Q.44 Who among the following musicians was shortlisted for the Bharat Ratna in 2019?

- Ans**
- 1. Lata Mangeshkar
 - 2. Pandit Ravi Shankar
 - 3. Pandit Bhimsen Joshi
 - 4. Bhupen Hazarika

Q.45 The Dachigam National Park is best known as the home of the _____.

- Ans**
- 1. crocodile
 - 2. hangul
 - 3. rhinoceros
 - 4. lion

Q.46 Which of the following Articles of the Indian Constitution, related to fundamental rights, CANNOT be suspended in emergency?

- Ans**
- 1. Articles 20-21
 - 2. Articles 29-30
 - 3. Articles 17-18
 - 4. Articles 31-32

Q.47 Who set up the task force on Supportive Policy and Regulatory Framework for Micro-Finance in India in 1999?

- Ans**
- 1. Finance minister
 - 2. NABARD
 - 3. RRB
 - 4. SBI

Q.48 Guru Vempati Chinna Satyam is associated with which of these dance forms?

- Ans**
- 1. Kuchipudi
 - 2. Odissi
 - 3. Manipuri
 - 4. Bharatanatyam

Q.49 Who has written the famous novel 'Apsara'?

- Ans**
- 1. Jaishankar Prasad
 - 2. Sumitranandan Pant
 - 3. Mahadevi Verma
 - 4. Suryakant Tripathi Nirala

Q.50 For which of the following dance forms was Gaddam Padmaja Reddy awarded the Padma Shri in 2022?

- Ans**
- 1. Sattriya
 - 2. Kuchipudi
 - 3. Bharatanatyam
 - 4. Kathak

Section : Reasoning

Prepare 50% Faster

Q.1 Select the figure that will replace the question mark (?) in the following figure series.



Ans

✗ 1.



✗ 2.



✓ 3.



✗ 4.



Q.2 Which two signs should be interchanged to make the following equation correct?

$$6 + 108 \div 12 - 24 \times 8 = 38$$

Ans ✗ 1. + and -

✓ 2. + and ×

✗ 3. - and +

✗ 4. - and ×

Q.3 Three statements are given followed by conclusions numbered 1, 2 and 3. Assuming the statements to be true, even if they seem to be at variance with commonly known facts, decide which of the conclusions logically follow(s) from the statements.

Statements:

1. All books are journals.
2. All journals are novels.
3. Some poems are novels.

Conclusions:

1. Some novels are books.
2. Some poems are journals.
3. All the journals are books.

Ans ✓ 1. Only conclusion 1 follows.

✗ 2. Only conclusion 2 follows

✗ 3. Both conclusions 1 and 2 follow.

✗ 4. Both conclusions 2 and 3 follow.

Q.4 Select the option that is related to the fifth number in the same way as the second number is related to the first number and fourth number is related to the third number.

$$64 : 23 :: 121 : 26 :: 256 : ?$$

Ans ✗ 1. 29

✓ 2. 31

✗ 3. 33

✗ 4. 27

Q.5 Six students are sitting around a circular table facing the centre. Yamini is an immediate neighbour of both Yojna and Yogeta. Yashmita is sitting second to the left of Yojna. Yukti is sitting second to the right of Yamini. Yashvi is sitting to the right of Yogeta. Who is an immediate neighbour of both Yukti and Yamini?

- Ans
- 1. Yashmita
 - 2. Yogeta
 - 3. Yashvi
 - 4. Yojna

Q.6 How many triangles are there in the following figure?

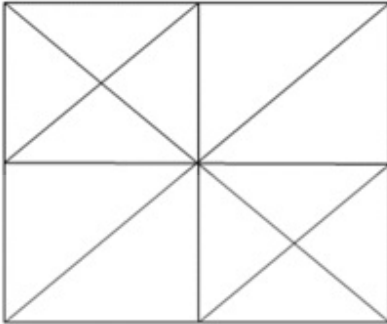

- Ans
- 1. 28
 - 2. 20
 - 3. 25
 - 4. 23



Prepare 50% Faster

Q.7 Which of the following option figures will complete the pattern in the figure given below?



Ans

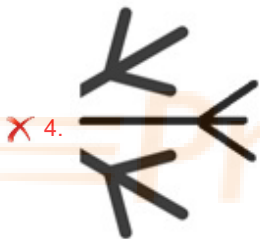
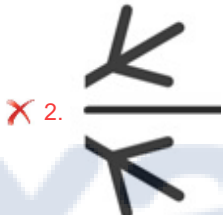
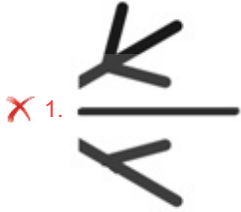

Q.8 Select the correct mirror image of the given combination when the mirror is placed at 'PQ' as shown below.



Ans



Q.9 Select the option figure that will replace the question mark (?) in the figure given below to complete the pattern.

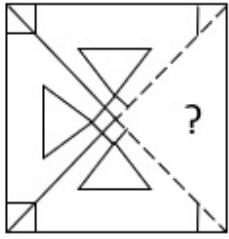

Ans

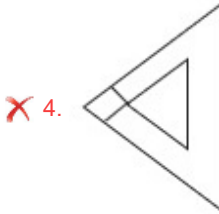
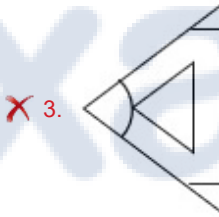
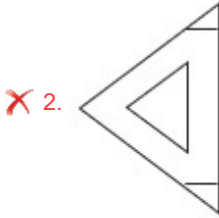
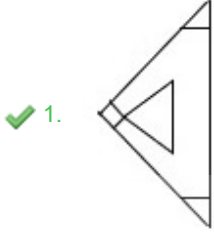

Q.10 In a certain code language, if BEAUTY is coded as 3-6-2-22-21-26 and CREAM is coded as 4-19-6-2-14, then how will HONESTY be coded?

- Ans
- ✓ 1. 9-16-15-6-20-21-26
 - ✗ 2. 7-14-14-4-19-19-24
 - ✗ 3. 7-14-13-4-18-19-24
 - ✗ 4. 8-15-14-5-19-20-25

Q.11 Select the figure from the options that can replace the question mark (?) and complete the given pattern.

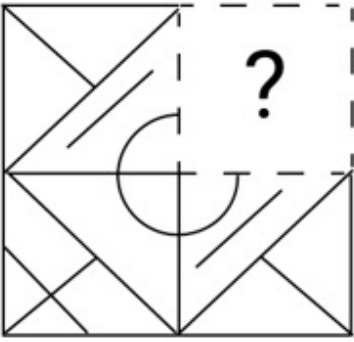

Ans

✗ 1.



✗ 2.



✓ 3.



✗ 4.

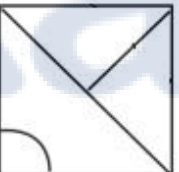

Q.12 Select the correct mirror image of the given figure when the mirror is placed at MN as shown below.

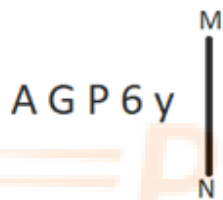

Ans

✓ 1. y θ ρ θ A

✗ 2. y ρ ρ y A

✗ 3. y θ ρ P A

✗ 4. y ρ ρ y A

Q.13 Select the option in which the given figure is embedded (rotation is NOT allowed).

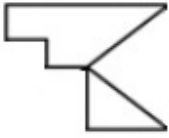

Ans

1.

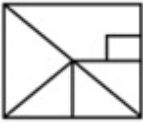

2.



3.

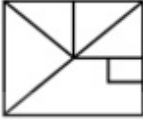

4.

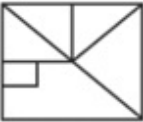

Q.14 Select the number from among the given options that can replace the question mark (?) in the following series.

300000, 90000, 27000, 8100, 2430, ?

Ans

1. 729

2. 323

3. 645

4. 3255

Q.15 A paper is folded and cut as shown below. How will it appear when unfolded?

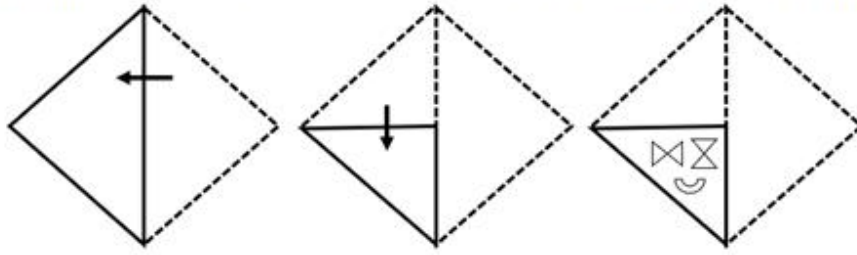

Ans

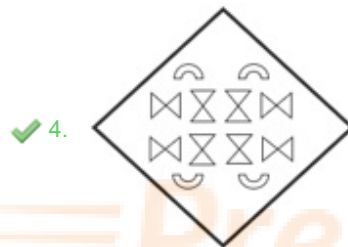
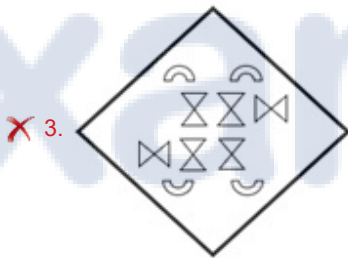
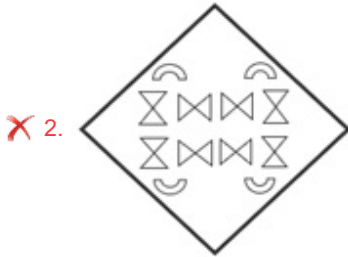
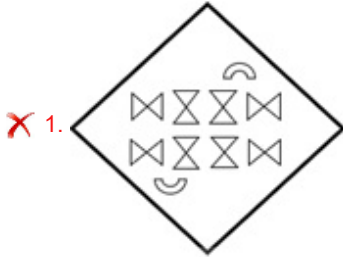

Q.16 If A denotes \div , B denotes \times , C denotes $+$ and D denotes $-$, then what will be the value of the following equation?
8 B 8 A 4 C 5 D 3 =?

- Ans
- ✗ 1. 19
 - ✓ 2. 18
 - ✗ 3. 17
 - ✗ 4. 21

Q.17 Select the set in which the numbers are related in the same way as are the numbers of the following sets.

(NOTE : Operations should be performed on the whole numbers, without breaking down the numbers into its constituent digits. E.g. 13 – Operations on 13 such as adding /deleting /multiplying etc. to 13 can be performed. Breaking down 13 into 1 and 3 and then performing mathematical operations on 1 and 3 is not allowed.)

(6, 36, 144)
(9, 81, 324)

- Ans
- ✓ 1. (14, 196, 784)
 - ✗ 2. (14, 196, 764)
 - ✗ 3. (15, 195, 784)
 - ✗ 4. (14, 186, 784)

Q.18 Six letters, J, K, L, M, N and O, are written on the different faces of a dice. Two positions of this dice are shown in figure. Find the letter on the face opposite to K?

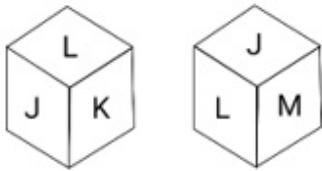

- Ans
- 1. L
 - 2. M
 - 3. N
 - 4. J

Q.19 A cube (dice) has six different symbols drawn over its six faces. Three different positions of this cube are shown in the given figure. Which symbol is on the face opposite to '*' (star)?

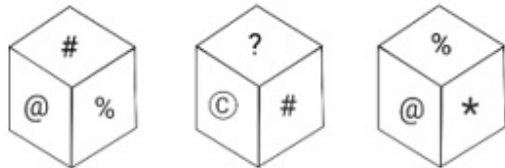

- Ans
- 1. @
 - 2. ?
 - 3. #
 - 4. %

Q.20 Select the option that is related to the fifth letter-cluster in the same way as the second letter-cluster is related to the first letter-cluster and the fourth letter-cluster is related to the third letter-cluster.
TRUE : RPSC :: COPY : AMNW :: MIND : ?

- Ans
- 1. KGKA
 - 2. KGLA
 - 3. KGKB
 - 4. KGLB

Q.21 A dice with six faces is marked with six numbers 1, 2,3,4,5 and 6, respectively. It is rolled 2 times and lands on the positions shown below. Which number is on the opposite plane of 5?

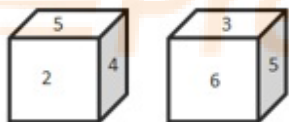

- Ans
- 1. 6
 - 2. 2
 - 3. 3
 - 4. 1

Q.22 Which figure should replace the question mark (?) if the following series were to be continued?

C	S	P	D	K	P	V	S	Z	V											
P	K	X	D	Z	C	S	V	V	Z	C	S	X	K	P	D	D	X	K	P	?
Z		V	K		X	X		D	Z		C	C		S						

Ans

✗ 1.

C	S		
Z	K	X	V
D	P		

✗ 2.

D	P		
C	X	K	S
Z	V		

✗ 3.

C	S		
P	K	X	D
Z	V		

✓ 4.

D	P		
C	Z	V	S
X	K		

Q.23 Which of the following terms will replace the question mark (?) in the given series?
RNVG, PPRK, ?, LTJS, JVFW

- Ans
- ✗ 1. MRMO
 - ✗ 2. NSNP
 - ✓ 3. NRNO
 - ✗ 4. MSNP

Prepare 50% Faster

Q.24 Identify the figure given in the options which when put in place of the question mark (?), will logically complete the

		X			
↑	X	X	↑	↑	?
		↑		X	

Ans

✓ 1.

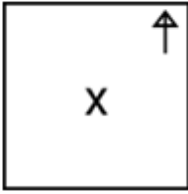

✗ 2.

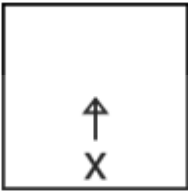

✗ 3.

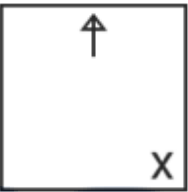

✗ 4.

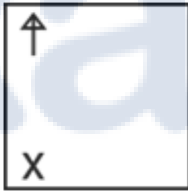

Prepare 50% Faster

Q.25 A square sheet of paper is folded along the dotted line successively along the directions shown and is then punched last. How would the paper look when unfolded?

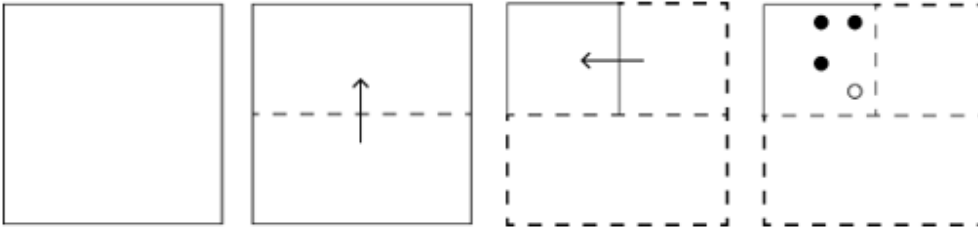

Ans

✗ 1.

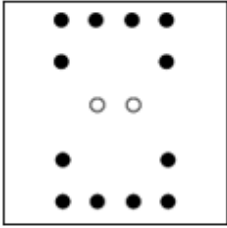

✗ 2.

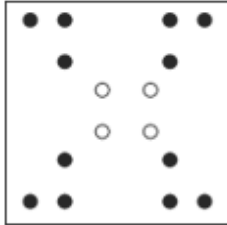

✓ 3.

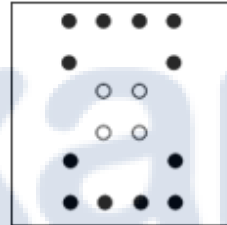

✗ 4.

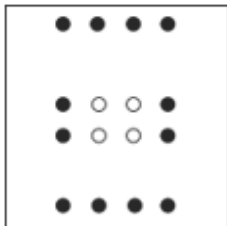

Section : Numerical Ability

Q.1 If 9 lines of a print, in a column of a book, contain 36 words, how many words will a column of 51 lines contain?

- Ans
- ✗ 1. 196
 - ✗ 2. 208
 - ✓ 3. 204
 - ✗ 4. 192

Q.2 Find the largest number which divides 60, 135 and 235 to leave the same remainder in each case.

- Ans
- ✗ 1. 35
 - ✗ 2. 45
 - ✓ 3. 25
 - ✗ 4. 50

Q.3 The average score of all the students in a test of class X is 85. If sum of the marks of all girls is 3500 and that of boys is 2025, then find the number of students in the class.

- Ans
- 1. 65
 - 2. 55
 - 3. 68
 - 4. 64

Q.4 Rahul has 12 bananas with him. He sells x of them at a profit of 20% and the remaining at a loss of 20%. He gains 10% on the whole outlay. The value of x is:

- Ans
- 1. 10
 - 2. 8
 - 3. 7
 - 4. 9

Q.5 The area of an isosceles triangle ABC with $AB = AC$ and altitude $AD = 9$ cm is 36 cm². What is its perimeter?

- Ans
- 1. $4 + 2\sqrt{97}$ cm
 - 2. $10 + \sqrt{97}$ cm
 - 3. $6 + 2\sqrt{97}$ cm
 - 4. $8 + 2\sqrt{97}$ cm

Q.6 A car travelling at $\frac{5}{8}$ of its actual speed covers 52 km in 1 hour 20 min 40 sec. What is the actual speed of the car (in km/h)?

- Ans
- 1. 68.78
 - 2. 61.88
 - 3. 65.82
 - 4. 75.87

Q.7 At what rate of interest per annum will a sum of ₹1,300 give ₹650 as simple interest in 10 years?

- Ans
- 1. 5%
 - 2. 4%
 - 3. 7%
 - 4. 8%

Q.8 Find the area of a triangle (in cm²) having sides 3cm, 6cm and 7cm.

- Ans
- 1. 4
 - 2. $4\sqrt{5}$
 - 3. $\sqrt{5}$
 - 4. $5\sqrt{6}$

Q.9 In an election between two candidates, the winning candidate got 60% of the votes polled and won by 18,600. What was the number of votes polled for the losing candidate?

- Ans
- 1. 36,400
 - 2. 34,600
 - 3. 37,200
 - 4. 35,800

Q.10 If 483y718 is divisible by the prime number 11, where y is a digit, then what is the value of y?

- Ans
- 1. 4
 - 2. 5
 - 3. 3
 - 4. 2

Q.11 A sum of ₹1,900 is divided among A, B and C such that B gets ₹100 more than A and C gets ₹200 more than B. The ratio of their shares is:

- Ans
- 1. 5 : 6 : 8
 - 2. 5 : 7 : 8
 - 3. 4 : 5 : 7
 - 4. 6 : 7 : 9

Q.12 A shopkeeper fixes the marked price of an item 45% above its cost price'. The percentage of discount allowed to gain 16% is:

- Ans
- 1. 26%
 - 2. 29%
 - 3. 25%
 - 4. 20%

Q.13 A pipe is cut into two pieces. The shorter piece is 40% of the length of the pipe. By how much percentage is the shorter piece shorter than the longer piece?

- Ans
- 1. $31\frac{2}{3}\%$
 - 2. $28\frac{2}{3}\%$
 - 3. $25\frac{1}{3}\%$
 - 4. $33\frac{1}{3}\%$

Q.14 The difference between the compound interest and the simple interest on a principal of ₹54,000 is ₹1,215 at the same yearly rate of interest for a period of 2 years. Find the rate of interest.

- Ans
- 1. 12%
 - 2. 15%
 - 3. 18%
 - 4. 10%

Q.15 The LCM of 148 and 205 is:

- Ans
- 1. 25441
 - 2. 28540
 - 3. 32640
 - 4. 30340

Section : Computer Proficiency

Q.1 Which wireless technology allows devices to connect to the internet within the limited range of a wireless router?

- Ans
- 1. LTE
 - 2. Wi-Fi
 - 3. 3G
 - 4. DSL

Q.2 Which of the following is used in MS Word 365 to split text into two or more columns?

- Ans**
- 1. Margins
 - 2. Rows
 - 3. Orientation
 - 4. Columns

Q.3 What is the definition of a workbook in Microsoft Excel 365?

- Ans**
- 1. A workbook is a group of rows.
 - 2. A workbook is a group of worksheets.
 - 3. A workbook is a group of cells.
 - 4. A workbook is a group of blocks.

Q.4 Which option is used to paste copied text at a specific location in Microsoft Word 365?

- Ans**
- 1. Paste Special
 - 2. Paste Destination Styles
 - 3. Paste As Hyperlink
 - 4. Paste Link

Q.5 What is the general functionality of Mail Merge in the MS-Word 365?

- Ans**
- 1. To create and send bulk emails
 - 2. To create and receive bulk emails
 - 3. To delete and remove bulk emails
 - 4. To restore the deleted emails

Q.6 In MS Excel 365, Which of the following type of charts in MS Excel compares various items of the data, that change over a period of time and the categories are arranged in horizontal axis and values with the vertical axis?

- Ans**
- 1. Bar chart
 - 2. Pie chart
 - 3. Line chart
 - 4. Column chart

Q.7 Which area in MS-Word 365 contains icons for common tasks and actions, providing quick access to frequently used commands?

- Ans**
- 1. Status Bar
 - 2. Navigation Pane
 - 3. Ribbon
 - 4. Quick Access Toolbar

Q.8 In MS Excel 365, how can we change page orientation in Print Preview?

- Ans**
- 1. By using Show Margins
 - 2. By using Zoom
 - 3. By using Print dialog box
 - 4. By using Page Setup dialog box

Q.9 Which of the following parts of the email contains the address of the sender and recipient?

- Ans**
- 1. Footer
 - 2. Header
 - 3. Complimentary close
 - 4. Body

Q.10 What is the shortcut key to initiate a spelling check in Microsoft Word 365?

Ans 1. F8

2. F7

3. F6

4. F5



 Prepare 50% Faster

Constable Executive Male and Female in Delhi Police Examination 2023

Exam Date	29/11/2023
Exam Time	12:00 PM - 1:30 PM
Subject	Constable Executive Male and Female in Delhi Police Examination 2023

Section : General Knowledge

Q.1 Which of the following is NOT an objective of the Fundamental Rights which are mentioned in the Indian Constitution?

- Ans**
- 1. Establish a government of laws and not of men
 - 2. Drive the citizens towards the objectives of the government
 - 3. Promote the ideal of political democracy
 - 4. Prevent the establishment of an authoritarian and despotic rule

Q.2 As per the recent NFHS-5 (2019-21) report, what percentage of children under the age of five are underweight in our country?

- Ans**
- 1. 32.1%
 - 2. 38.1%
 - 3. 21.0%
 - 4. 29.2%

Q.3 Who among the following is the founder of the Vrindavan Gurukul in Mumbai and Vrindavan Gurukul in Bhubaneswar?

- Ans**
- 1. Bhimsen Joshi
 - 2. M Balamurlikrishnan
 - 3. Shivkumar Sharma
 - 4. Hariprasad Chaurasia

Q.4 As per Human Development Report 2021-22, what is the percentage contribution of health deprivation in overall multidimensional poverty of India?

- Ans**
- 1. 31.3%
 - 2. 41.3%
 - 3. 31.9%
 - 4. 18.5%

Q.5 Which hymn from the Rigveda was used by the Brahmanas of ancient India to justify the Varna system?

- Ans**
- 1. Manas Sukta
 - 2. Purusha Sukta
 - 3. Brahm Sukta
 - 4. Varna Sukta

Q.6 Which of the following sets consists of only compounds?
 A) Sugar solution, Calcium carbonate, Methane, Baking soda
 B) Sugar, Calcium carbonate, Methane, Baking soda
 C) Sugar solution, Calcium, Methane, Baking soda
 D) Sugar solution, Calcium carbonate, Methane, Soda water

- Ans**
- 1. D
 - 2. A
 - 3. C
 - 4. B

Q.7 The brittle crust and the top part of the upper mantle of the earth is called:

- Ans
- 1. mesosphere
 - 2. lithosphere
 - 3. asthenosphere
 - 4. stratosphere

Q.8 In which year did Indian Railways start its first computerised reservation in New Delhi?

- Ans
- 1. 1986
 - 2. 1996
 - 3. 1992
 - 4. 2001

Q.9 Which of the following mausoleum shapes was found in the architecture of the Lodhi dynasty?

- Ans
- 1. Spherical
 - 2. Cylindrical
 - 3. Octagonal
 - 4. Circular

Q.10 Who among the following started the 'Shuddhi Movement' to bring back converted Hindus to the main Hindu society?

- Ans
- 1. Ishwar Chand Vidyasagar
 - 2. Swami Sahjanand
 - 3. Swami Vivekanand
 - 4. Swami Dayanand

Q.11 The English novel 'The Rainbow' was written by which of the following authors?

- Ans
- 1. Joseph Conrad
 - 2. Thomas Hardy
 - 3. D. H. Lawrence
 - 4. Emily Bronte

Q.12 कलागुरु विष्णु राभा पुरस्कार नृत्य और संगीत के क्षेत्र में किस सरकार द्वारा दिया जाता है?

- Ans
- 1. अरुणाचल प्रदेश
 - 2. पश्चिम बंगाल
 - 3. असम
 - 4. त्रिपुरा

Q.13 Which of the following Articles of the Indian Constitution declares that all laws that are inconsistent with or in derogation of the Fundamental Rights shall be void?

- Ans
- 1. Article 226
 - 2. Article 12
 - 3. Article 32
 - 4. Article 13

Q.14 U19 T20 Women's World Cup 2023 was organised by _____ .

- Ans
- 1. New Zealand
 - 2. South Africa
 - 3. England
 - 4. Australia

Q.15 In which of the following countries will you find the Magar and Tharu ethnic communities?

- Ans**
- 1. Nepal
 - 2. Bhutan
 - 3. Afghanistan
 - 4. Sri Lanka

Q.16 Who among the following became the first Indian to be signed by Elektra Records, a U.S. company in October 2020?

- Ans**
- 1. Jim Ankan Deka
 - 2. Prateek Kuhad
 - 3. Vipin Aneja
 - 4. Kulwinder Dhillon

Q.17 In which of the following cases does revenue deficit occur?

- Ans**
- 1. When the government's total revenue exceeds its expenditure
 - 2. When the government's total revenue is equal to its expenditure
 - 3. When the government's revenue is added to its expenditure
 - 4. When the government's total revenue is less than its expenditure

Q.18 Name the dance form of North-West India in which dancers emulate the movements of snakes?

- Ans**
- 1. Kalbeliya
 - 2. Tera Tali
 - 3. Garba
 - 4. Siddi Dhamal

Q.19 Mumbai's famous Gateway of India was built in the memory of which British emperor's first arrival in India?

- Ans**
- 1. Charles I
 - 2. Ani Stuart
 - 3. King George V
 - 4. William IV

Q.20 The Chandela dynasty of Rajput clan ruled which of the following regions between 9th and 13th century in early medieval period of India?

- Ans**
- 1. Jaisalmer
 - 2. Amarkot
 - 3. Bundelkhand
 - 4. Mewar

Q.21 Who among the following was chosen by Gandhiji as the first Satyagrahi of the individual Satyagraha movement?

- Ans**
- 1. Gopal Krishna Gokhale
 - 2. Dr. BR Ambedkar
 - 3. Acharya Vinoba Bhave
 - 4. C Rajagopalachari

Q.22 Chhath Pooja is mainly celebrated in which of these states?

- Ans**
- 1. Haryana
 - 2. Punjab
 - 3. Odisha
 - 4. Bihar

Q.23 Which climatologist collaborated with Koppen in 1961 to modify the scheme of climate classification?

- Ans
- 1. Nerilie Abram
 - 2. Richard Alley
 - 3. Jacob Bjerknes
 - 4. Rudolf Geiger

Q.24 Who among the following is the fourth Chief Election Commissioner of India?

- Ans
- 1. T Swaminathan
 - 2. SP Sen Verma
 - 3. KVK Sundaram
 - 4. Nagendra Singh

Q.25 From which country is the concept of independence of the judiciary in the Indian Constitution taken?

- Ans
- 1. United States of America
 - 2. South Africa
 - 3. Germany
 - 4. Australia

Q.26 _____ refers to relaxation of government restrictions.

- Ans
- 1. Globalisation
 - 2. Disinvestment
 - 3. Liberalisation
 - 4. Privatisation

Q.27 Consider the following statements with respect to establishment of SEWA Bank, a microfinance institution in India.

- (i) SEWA Bank was established in 1974.
- (ii) SEWA Bank was established in Gujarat.
- (iii) SEWA Bank was established by the Self- employed Women's Association.

Choose the correct answer.

- Ans
- 1. Only (iii) is true
 - 2. Only (i) is true
 - 3. Only (ii) is true
 - 4. (i), (ii) and (iii) are true

Q.28 Which of the following features conveys the meaning 'creating equalitarian society' ?

- Ans
- 1. Fundamental Rights
 - 2. Emergency provisions
 - 3. Federal system
 - 4. Written Constitution

Q.29 Habeas Corpus is the writ issued by the Court to bring before a court _____.

- Ans
- 1. a person who occupies a public office
 - 2. a person from illegal custody
 - 3. a tribunal from doing something in excess
 - 4. a person to perform his legal duty

Q.30 Who among the following chroniclers wrote his first chronicle in 1356?

- Ans
- 1. Minhaj-us-Siraj
 - 2. Ibn-Sina
 - 3. Ziyauddin Barani
 - 4. Al-Biruni

Q.31 The Olympic Games was organised in Asia for the first time in _____.

- Ans
- 1. 1968
 - 2. 1960
 - 3. 1964
 - 4. 1956

Q.32 The deficiency of iodine causes _____.

- Ans
- 1. goitre
 - 2. Scurvy
 - 3. Beriberi
 - 4. Rickets

Q.33 In which Olympics did PV Sindhu win a silver medal?

- Ans
- 1. 2012 Summer Olympics (London)
 - 2. 2008 Summer Olympics (Beijing)
 - 3. 2016 Summer Olympics (Rio)
 - 4. 2020 Summer Olympics (Tokyo)

Q.34 According to Livestock Census of India 2019, the population of which of the following categories of livestock recorded the highest?

- Ans
- 1. Goats
 - 2. Cattle
 - 3. Buffalo
 - 4. Sheep

Q.35 IR-8 is a dwarf variety of which crop?

- Ans
- 1. Rice
 - 2. Wheat
 - 3. Barley
 - 4. Maize

Q.36 Which of the following bodies looked after the various aspects of the Competition Act 2002?

- Ans
- 1. SEBI
 - 2. Competition Commission of India
 - 3. Reserve Bank of India
 - 4. UPSC

Q.37 In 1889, _____ established the Mukti Mission, in Pune, a refuge for young widows who had been deserted and abused by their families.

- Ans
- 1. Kasturba Gandhi
 - 2. Pandita Ramabai
 - 3. Laxmi Sehgal
 - 4. Sarojini Naidu

Q.38 Which of the following Ministries has the responsibility to organise the Republic Day Parade in Delhi ?

- Ans
- 1. Ministry of Culture
 - 2. Ministry of Defence
 - 3. Ministry of Home Affairs
 - 4. Ministry of Civil Aviation

Q.39 The tribal dance Daang is associated with which Indian state?

- Ans
- 1. Odisha
 - 2. Gujarat
 - 3. Karnataka
 - 4. Madhya Pradesh

Q.40 In which year was the Pradhan Mantri Kaushal Vikas Yojana launched?

- Ans
- 1. 2015
 - 2. 2014
 - 3. 2017
 - 4. 2016

Q.41 Deba Prasad Das, Pankaj Charan Das and Gangadhar Pradhan were the famous exponents of which of the following dance forms?

- Ans
- 1. Odissi
 - 2. Sattriya
 - 3. Kathak
 - 4. Bharatnatyam

Q.42 Which article empowers the Supreme Court to exercise the jurisdiction and powers of the federal court under any pre-constitution law?

- Ans
- 1. Article 140
 - 2. Article 135
 - 3. Article 144
 - 4. Article 139

Q.43 Due to the need for irrigation facilities and pesticides/fertilisers, the first phase of the Green Revolution benefitted few affluent states such as _____.

- Ans
- 1. Punjab, Andhra Pradesh and Uttar Pradesh
 - 2. Punjab, Andhra Pradesh and Bihar
 - 3. Punjab, Arunachal Pradesh and Uttar Pradesh
 - 4. Punjab, Andhra Pradesh and Tamil Nadu

Q.44 In Kabaddi, how many players per team are allowed on the field of play at any one time?

- Ans
- 1. 10
 - 2. 12
 - 3. 8
 - 4. 7

Q.45 Which of the following was the revenue collecting officer (collector general of revenue) in the Mauryan administration?

- Ans
- 1. Sannidhata
 - 2. Amatya
 - 3. Samaharta
 - 4. Antapala

Q.46 The city of Kolar in Karnataka is renowned for its _____ mines.

- Ans
- 1. copper
 - 2. gold
 - 3. limestone
 - 4. silver

Q.47 The Khilafat Movement started in India _____ .

- Ans
- 1. to oppose the restrictions upon freedom of press
 - 2. to oppose the massacre at Jallianwala Bagh
 - 3. to protest against communal electorates
 - 4. to defend the Islamic caliphate in Turkey

Q.48 By which of the following authors is the English novel 'Three Men in a Boat' written?

- Ans
- 1. Robert Louis Stevenson
 - 2. Mark Twain
 - 3. Arthur Conan Doyle
 - 4. Jerome K Jerome

Q.49 What was the launch year of 'Pandit Deen Dayal Upadhyay Unnat Krishi Shiksha Yojana'?

- Ans
- 1. 2015
 - 2. 2016
 - 3. 2000
 - 4. 1998

Q.50 Which of the following was first introduced in bacterial cells by the American molecular biologist Joshua Lederberg in 1952?

- Ans
- 1. Cytoplasm
 - 2. Plasmid
 - 3. Capsule
 - 4. Pili

Section : Reasoning

Prepare 50% Faster

Q.1 Which figure should replace the question mark (?) in the following series to continue the pattern?

0	3	3	S	S	=	=	0	
	D		=		3		6	?
6	=	S	0	D	6	D	6	0
							S	3
								D

Ans

✗ 1.

D		6
	S	
0	=	3

✓ 2.

0		6
	=	
3	D	S

✗ 3.

D		=
	0	
6	S	3

✗ 4.

6	=	
	0	
D	S	3

Q.2 Two statements are given followed by two conclusions numbered I and II. Assuming the statements to be true, even if they seem to be at variance from commonly known facts, decide which of the conclusions logically follow(s) from the statements.

Statements:

All Mugs are Buckets.

Some Mugs are Tumblers.

Conclusions:

I. All Tumblers are Mugs.

II. All Buckets are Tumblers.

Ans ✓ 1. Neither conclusion I nor II follows.

✗ 2. Only conclusion II follows.

✗ 3. Both conclusions I and II follow.

✗ 4. Only conclusion I follows.

Q.3 How many triangles are there in the given figure?

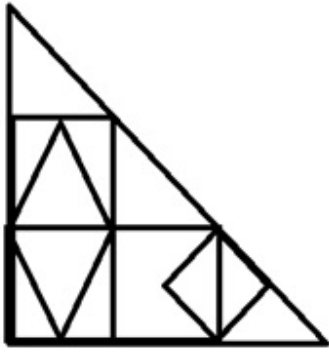

- Ans
- 1. 18
 - 2. 14
 - 3. 15
 - 4. 16

Q.4 In a certain code language, 'BATH' is written as '542311' and 'FUND' is written as '924177'. How will 'GOLD' be written in that language?

- Ans
- 1. 1018157
 - 2. 915157
 - 3. 914156
 - 4. 1016179

Q.5 Select the number from among the given options that can replace the question mark (?) in the following series.

15, 24, 42, 78, 150, ?

- Ans
- 1. 452
 - 2. 323
 - 3. 294
 - 4. 5432

Q.6 Select the set in which the numbers are NOT related in the same way as are the numbers of the following sets.

(7, 245, 7), (8, 200, 5)

(NOTE: Operations should be performed on the whole numbers, without breaking down the numbers into its constituent digits.)

- Ans
- 1. (6, 270, 9)
 - 2. (16, 560, 7)
 - 3. (12, 420, 7)
 - 4. (11, 396, 9)

Q.7 A square sheet of paper is folded along the dotted line successively along the directions shown and is then punched last. How would the paper look when unfolded?

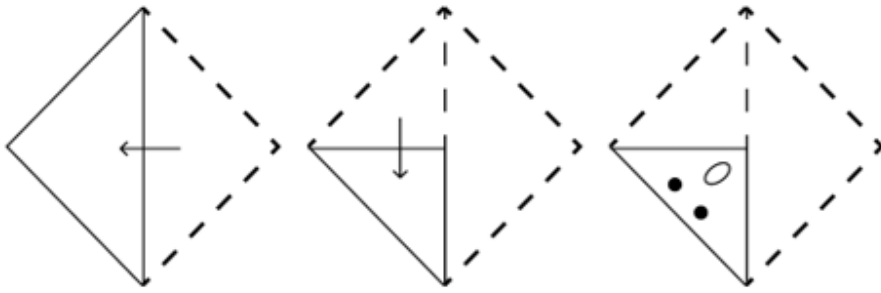

Ans

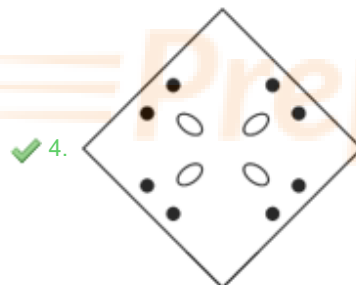
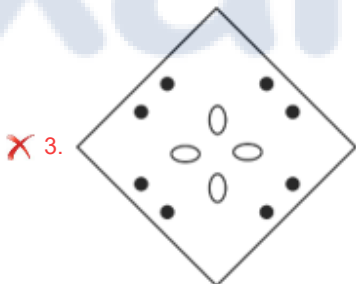
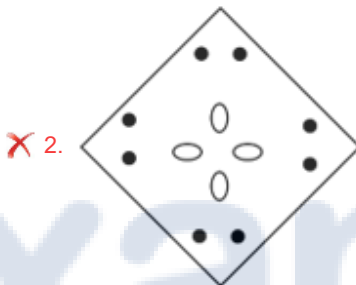
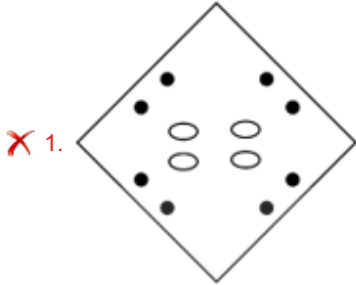

Q.8 Select the option that represents the letters that, when sequentially placed from left to right in the blanks below, will complete the letter series.
H A _ _ E _ _ Y N E H A Y _ _ H _ _ N E

- Ans
- ✓ 1. YNHANEAY
 - ✗ 2. YHNANEAY
 - ✗ 3. YHNENEAY
 - ✗ 4. YHNAEAEY

Q.9 Select the correct mirror image of the given combination when the mirror is placed at 'PQ' as shown below.

P
|
G Z E K 4 L
|
Q

- Ans
- 1. J 4 K E Z G
 - 2. J 4 K E Z G
 - 3. G Z E K 4 L
 - 4. J 4 K E Z G

Q.10 Three different positions of the same dice are shown. Find the number on the face opposite to the face showing '2'.

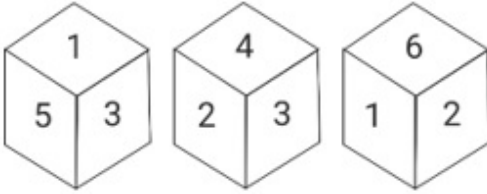

- Ans
- 1. 1
 - 2. 4
 - 3. 5
 - 4. 3

Q.11 Select the option that is related to the fourth term in the same way as the first term is related to the second term and the fifth term is related to the sixth term.
126 : 14 :: ? : 38 :: 207 : 23

- Ans
- 1. 354
 - 2. 342
 - 3. 380
 - 4. 364

Prepare 50% Faster

Q.12 Select the option figure that will replace the question mark (?) in the figure given below to complete the pattern.

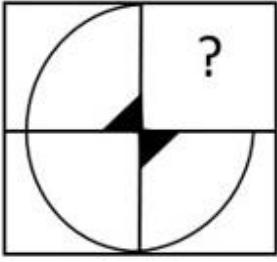

Ans

1.



2.

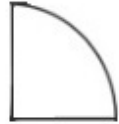

3.



4.



Q.13 Select the correct combination of mathematical signs that can sequentially replace the * signs and balance the given equation.

$$7 * 10 * 5 * 6 * 4 * 15$$

Ans 1. ÷, -, ×, +, =

2. +, -, ×, ÷, =

3. +, ×, -, ÷, =

4. +, ÷, ×, -, =

Q.14 Which of the following option figures will complete the pattern in the figure given below?



Ans

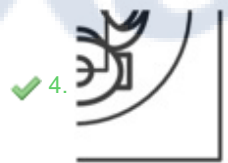
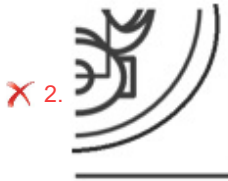

Prepare 50% Faster

Q.15 Select the figure that will replace the question mark (?) in the following figure series.

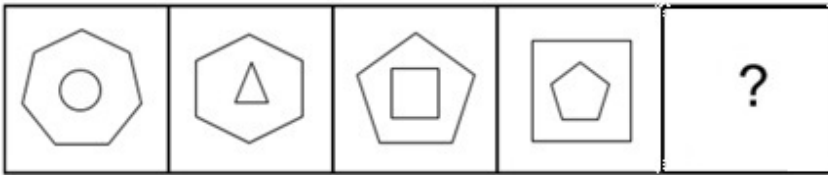

Ans

✗ 1.

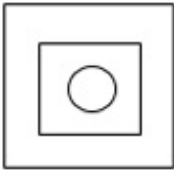

✓ 2.

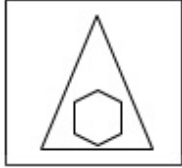

✗ 3.



✗ 4.

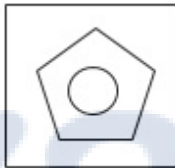

Q.16 Select the option that is related to the third word in the same way as the second word is related to the first word.
(The words must be considered as meaningful English words and must not be related to each other based on the number of letters / number of consonants / vowels in the word)
Phycology : Algae :: Palaeontology : ?

Ans

✗ 1. Fungi

✓ 2. Fossils

✗ 3. Insects

✗ 4. Plants

Prepare 50% Faster

Q.17 Select the option figure which is embedded in the given figure (Rotation is NOT allowed).

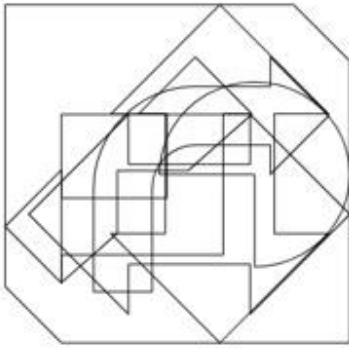

Ans

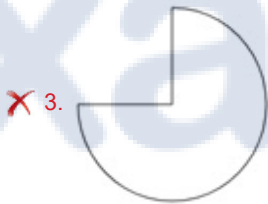

Q.18 Six students are sitting around a circular table facing the centre. Jasbir is an immediate neighbour of both Charan and Jagdish. Chetan is sitting second to the right of Jagdish. Palash is sitting third to the right of Charan. Pankaj is an immediate neighbour of both Charan and Chetan. Who is an immediate neighbour of both Jasbir and Palash?

- Ans
- ✗ 1. Pankaj
 - ✓ 2. Jagdish
 - ✗ 3. Chetan
 - ✗ 4. Charan

Q.19 Which figure should replace the question mark (?) in the following series to continue the pattern?

X P △ Z ↑ 6	P X D 6 Z △	↑ △ 6 X D Z	P 6 △ P ↑ X	Z	?
----------------------------	----------------------------	----------------------------	----------------------------	---	---

Ans

✓ 1.

X ↑ △ P D Z

✗ 2.

△ P ↑ D Z 6

✗ 3.

Z ↑ △ P 6 X

✗ 4.

D 6 △ P Z ↑

Q.20 Which two signs should be interchanged to make the following equation correct?

$$144 \div 12 + 6 \times 3 - 14 = 8$$

Ans

✗ 1. + and ×

✗ 2. ÷ and ×

✓ 3. - and +

✗ 4. - and ×

Q.21 Select the option in which the given figure is embedded (rotation is NOT allowed).



Ans

✓ 1.

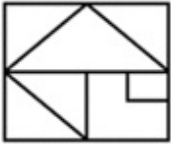

✗ 2.



✗ 3.

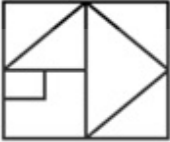

✗ 4.



Q.22 Select the correct mirror image of the given combination when the mirror is placed at 'MN' as shown below.

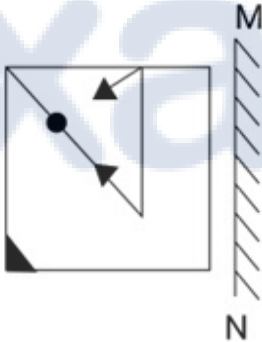

Ans

✗ 1.

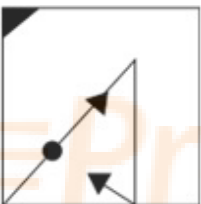

✗ 2.

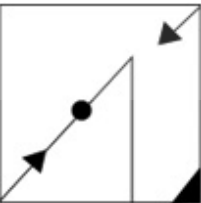

✗ 3.



✓ 4.

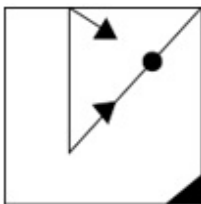

Q.23 Select the option figure that will replace the question mark (?) in the figure given below to complete the pattern.



Ans

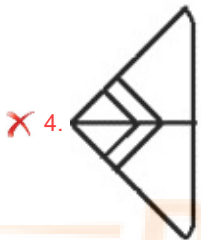
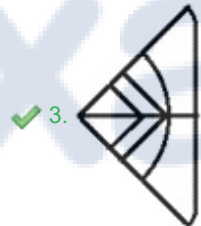
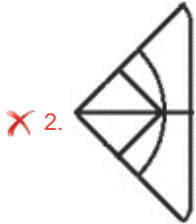
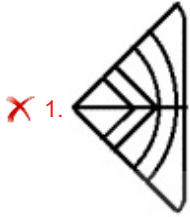

Q.24 Which of the following option figures will complete the pattern in the figure given below?

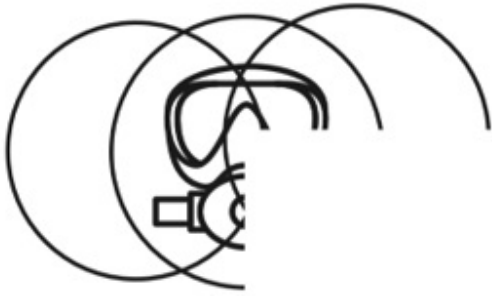

Ans



Prepare 50% Faster

Q.25 Select the option figure that will replace the question mark (?) in the figure given below to complete the pattern.

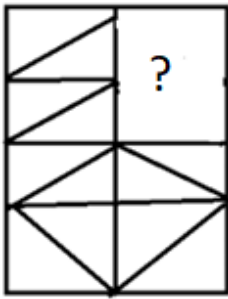

Ans

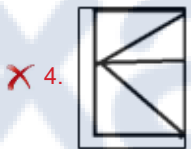
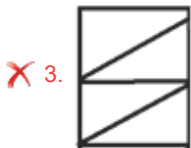
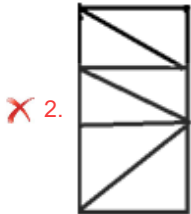
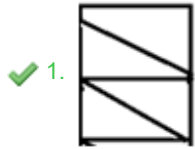

Section : Numerical Ability

Q.1 संख्या 0.0623, $\frac{1}{16}$ से कितनी कम है?

- Ans
- ✗ 1. $\frac{1}{1500}$
 - ✗ 2. $\frac{1}{15000}$
 - ✗ 3. $\frac{1}{500}$
 - ✓ 4. $\frac{1}{5000}$

Q.2 The radii of the bases of two cylinders are in the ratio 3 : 7 and their heights are in the ratio 7 : 9. Find the ratio of their curved surface areas.

(Take $\pi = \frac{22}{7}$)

- Ans
- ✗ 1. 2 : 3
 - ✗ 2. 3 : 1
 - ✓ 3. 1 : 3
 - ✗ 4. 3 : 4

Q.3 If the average of 5 consecutive even numbers is 70, then the largest even number is:

- Ans
- 1. 68
 - 2. 70
 - 3. 74
 - 4. 66

Q.4 The marked price of a commodity was ₹2,875. The seller offered a discount of 8% on its sale and still made a profit of 15%. What was the cost price (in ₹) of the commodity?

- Ans
- 1. 2275.75
 - 2. 2375
 - 3. 2300
 - 4. 2248.25

Q.5 6 boys can complete a work in 18 hours. In how many hours will 16 boys complete the same work?

- Ans
- 1. $6\frac{1}{4}$
 - 2. $5\frac{3}{4}$
 - 3. $6\frac{3}{4}$
 - 4. $3\frac{1}{4}$

Q.6 On a certain sum of money, the difference between the compound interest for a year payable half-yearly, and the simple interest for a year is ₹729. If the rate of interest in both the cases is 6%, then the sum is:

- Ans
- 1. ₹7,90,000
 - 2. ₹8,10,000
 - 3. ₹8,30,000
 - 4. ₹8,50,000

Q.7 Simplify.

$$0.7 \times 0.7 + 0.7 \div 7 + 7 \div 700$$

- Ans
- 1. 0.69
 - 2. 0.60
 - 3. 0.59
 - 4. 0.70

Q.8 A train travelling at a speed of 54 km/h catches another train travelling in the same direction and then leaves it 70 m behind in 14 seconds. The speed of the second train is:

- Ans
- 1. 24 km/h
 - 2. 54 km/h
 - 3. 36 km/h
 - 4. 48 km/h

Q.9 What number must be added to each term of ratio 3 : 5 so that it may equal to 5 : 6?

- Ans
- 1. 6
 - 2. 7
 - 3. 9
 - 4. 8

- Q.10** The monthly income of Amara is ₹80,200. If her income is decreased by 11%, then find her new monthly income (
- Ans** 1. 71,500
 2. 71,378
 3. 71,820
 4. 71,250

- Q.11** The area of a triangle is 182 cm^2 and the length of one of its sides is 28 cm. What is the length of the perpendicular line segment drawn to this side of the triangle from the opposite vertex (in cm)?
- Ans** 1. 12
 2. 13
 3. 14
 4. 6.5

- Q.12** A fruit seller sells $\left(\frac{2}{5}\right)$ part of the fruits at a profit of 15%, and remaining at a loss 5%. If the total profit is ₹1,800, then what is the total cost price of the fruits?
- Ans** 1. ₹45,000
 2. ₹50,000
 3. ₹55,000
 4. ₹60,000

- Q.13** The annual instalment of ₹750 in 5 years at 5% per annum simple interest will discharge a debt of _____.
- Ans** 1. ₹4,215
 2. ₹4,125
 3. ₹3,937.5
 4. ₹4,025

- Q.14** What is the remainder obtained when a prime number greater than 7 is divided by 6?
- Ans** 1. 1 or 5
 2. 2 or 3
 3. 3 or 5
 4. 2 or 5

- Q.15** The price of an article is first decreased by 25% and then increased by 35%. If the resulting price is ₹405, what was the original price of the article?
- Ans** 1. ₹300
 2. ₹350
 3. ₹450
 4. ₹400

Section : Computer Proficiency

- Q.1** Which folder in an email client is used to store received emails?
- Ans** 1. Inbox
 2. Sent Items
 3. Drafts
 4. Outbox

Q.2 What does the menu bar do in MS-Word 365?

- Ans**
- 1. It moves the window moving area upside
 - 2. Displays the title of the software
 - 3. Displays the current page number of the document
 - 4. Finds program essential functions

Q.3 In Microsoft Excel 365, which of the following keyboard shortcuts enables you to save a workbook?

- Ans**
- 1. Ctrl + G
 - 2. Ctrl + A
 - 3. Ctrl + F
 - 4. Ctrl + S

Q.4 Which operation can be used to move the text in a document of MS word 365?

- Ans**
- 1. Move-paste
 - 2. Cut-copy-paste
 - 3. Copy-paste
 - 4. Cut-paste

Q.5 In MS Excel 365, which of the following functions can be used to display the formula applied to a specific cell?

- Ans**
- 1. =FORMULATEXT(Cell_Reference)
 - 2. =RETFORMULA(Cell_Reference)
 - 3. =TEXTFORMULA(Cell_Reference)
 - 4. =CALLFORMULA(Cell_Reference)

Q.6 What is the primary function of FTP (File Transfer Protocol)?

- Ans**
- 1. Sending emails
 - 2. Video streaming
 - 3. Browsing websites
 - 4. Transferring files between computers

Q.7 Which of the following options is NOT used to set page margins in MS Word 365?

- Ans**
- 1. Left
 - 2. Header
 - 3. Bottom
 - 4. Right

Q.8 In MS-word 365, the keyboard shortcut Shift + F3 can be used to change the text document as:

- Ans**
- 1. Size of Font
 - 2. Bold Font
 - 3. Capitalize Each Word
 - 4. Highlight Text color

Q.9 What is the shortcut key for closing the documents in MS-Word 365?

- Ans**
- 1. Ctrl + W
 - 2. Ctrl + C
 - 3. Ctrl + Alt + S
 - 4. Ctrl + B

Q.10 In MS Excel 365, to enable the edit mode in MS-Excel worksheet, we should follow:

- Ans
- ✗ 1. File > Advanced > Editing options > Options
 - ✓ 2. File > Options > Advanced > Editing options
 - ✗ 3. File > Advanced > Editing options
 - ✗ 4. File > Options > Editing options



Prepare 50% Faster

Constable Executive Male and Female in Delhi Police Examination 2023

Exam Date	29/11/2023
Exam Time	3:00 PM - 4:30 PM
Subject	Constable Executive Male and Female in Delhi Police Examination 2023

Section : General Knowledge

Q.1 Which of the following statements about cell is correct?

- Ans**
- 1. Bacterial cell contains cellulose.
 - 2. Cell membrane of a cell is hard and rigid.
 - 3. Powerhouse of a cell is plastid.
 - 4. Cell is a functional unit of life.

Q.2 Who is the writer of the famous autobiography 'The Story of My Life'?

- Ans**
- 1. Anne Frank
 - 2. Steve Jobs
 - 3. Mahatma Gandhi
 - 4. Helen Keller

Q.3 Which part of our body is responsible for digestion?

- Ans**
- 1. Heart
 - 2. Kidney
 - 3. Gastric glands
 - 4. Hands

Q.4 The inscription on the pillar of Allahabad written by Harishena is in which language?

- Ans**
- 1. Persian
 - 2. Prakrit
 - 3. Pali
 - 4. Sanskrit

Q.5 _____ aims to provide permanent shelter equipped with essential services to the urban homeless in a phased manner under the Scheme of Shelter for Urban Homeless (SUH).

- Ans**
- 1. Gramin Awas Yojana
 - 2. National Urban Livelihoods Mission (NULM)
 - 3. Pradhan Mantri Awas Yojana
 - 4. Rajiv Awas Yojana

Q.6 Which of the following is a policy that promotes privatisation?

- A. Disinvestment
- B. Outsourcing
- C. Urbanisation

- Ans**
- 1. Only A
 - 2. All – A, B and C
 - 3. Only A and B
 - 4. Both A and C

Q.7 Which Constitution Amendment Act provided that all the citizens shall have the fundamental right to form co-operative societies?

- Ans
- 1. 91st Amendment Act
 - 2. 99th Amendment Act
 - 3. 89th Amendment Act
 - 4. 97th Amendment Act

Q.8 Which method of national income accounting involves classifying production centres into primary, secondary and tertiary sectors?

- Ans
- 1. Residual approach
 - 2. Production approach
 - 3. Income approach
 - 4. Expenditure approach

Q.9 Shyamji Krishnavarma set up the India Home Rule society popularly known as India House for India's liberation at which place?

- Ans
- 1. Paris
 - 2. Berlin
 - 3. San Francisco
 - 4. London

Q.10 Which Article of the Indian Constitution mentions that 'The advice tendered by Ministers to the Governor shall NOT be inquired into in any court'?

- Ans
- 1. Article 167
 - 2. Article 161
 - 3. Article 168
 - 4. Article 163

Q.11 In which of the following years was the Telangana Legislative Assembly established?

- Ans
- 1. 2010
 - 2. 2014
 - 3. 2012
 - 4. 2013

Q.12 In a cricket match, the number of balls in an over is _____.

- Ans
- 1. 5
 - 2. 8
 - 3. 7
 - 4. 6

Q.13 When a cell is not dividing, its nucleus has highly extended and elaborate nucleoprotein fibres. What is it called?

- Ans
- 1. Fibromatin
 - 2. Tubulin
 - 3. Bromatin
 - 4. Chromatin

Q.14 Allah Rakha, Sabir Khan, Pandit Kishan Maharaj, Pandit Jnan Prakash Ghosh and Sandeep Das are noted players of which of the following instruments?

- Ans
- 1. Pakhawaj
 - 2. Tabla
 - 3. Ghatam
 - 4. Mridangam

Q.15 According to Census 2011, which union territory has the highest male literacy rate?

- Ans**
- 1. Lakshadweep
 - 2. Daman & Diu
 - 3. Delhi
 - 4. Puducherry

Q.16 With which Indian classical dance form is Sujata Mohapatra associated?

- Ans**
- 1. Bharatanatyam
 - 2. Kathak
 - 3. Sattriya
 - 4. Odissi

Q.17 Makar Dhwaja Darogha was honoured with the Padma Shri for which form of dance?

- Ans**
- 1. Kalbelia
 - 2. Mohiniattam
 - 3. Chhau
 - 4. Kathak

Q.18 Which of the following Indian states is known for its extensive tea plantations?

- Ans**
- 1. Punjab
 - 2. Rajasthan
 - 3. Assam
 - 4. Gujarat

Q.19 Which of the following features in the Constitution of India has been taken from the Government of India Act, 1935?

- Ans**
- 1. Federal Scheme
 - 2. Idea of Republic
 - 3. Joint sitting of the two houses of the Parliament
 - 4. Suspension of fundamental rights during emergency

Q.20 Who among the following was the Turkish ruler who invaded India with intent to rob in 1398?

- Ans**
- 1. Shahrukh Mirza
 - 2. Guyuk Khan
 - 3. Timur Lang
 - 4. Genghis Khan

Q.21 Under the LERMS system, what percentage of foreign exchange earnings can be converted at the official rate?

- Ans**
- 1. 20
 - 2. 25
 - 3. 40
 - 4. 35

Q.22 The Mahabodhi Temple is in which of these states?

- Ans**
- 1. Uttar Pradesh
 - 2. Chhattisgarh
 - 3. Bihar
 - 4. Madhya Pradesh

Q.23 Which of the following players is associated with fencing?

- Ans
- 1. Navjeet Kaur Dhillon
 - 2. CA Bhavani Devi
 - 3. Hima Das
 - 4. Parul Chaudhari

Q.24 Which Indian state has the world's longest highway tunnel (as of July 2023)?

- Ans
- 1. Himachal Pradesh
 - 2. Rajasthan
 - 3. Gujarat
 - 4. West Bengal

Q.25 After MK Gandhi's returning to India in 1915, who among the following advised him to travel around India to know the land and its people?

- Ans
- 1. Bipin Chandra Pal
 - 2. Gopal Krishna Gokhale
 - 3. Bal Gangadhar Tilak
 - 4. Chittaranjan Das

Q.26 In northeast India, the Ahoms celebrate this festival in a common place to worship their ancestors on 31st January every year with all traditional costumes and fanfare. Identify the festival.

- Ans
- 1. Jonbeel Mela
 - 2. Rongker
 - 3. Me Dam Me Phi
 - 4. Doljatra

Q.27 Vempati Chinna Satyam won the Padma Bhushan in the year 1998 for which form of dance?

- Ans
- 1. Kathakali
 - 2. Bharatnatyam
 - 3. Kuchipudi
 - 4. Kathak

Q.28 Kailash temple at Ellora and the Ratha temples of Mahabalipuram are examples of which type of temple architecture?

- Ans
- 1. Rock-cut
 - 2. Low platform
 - 3. Monolithic
 - 4. Panchayatan

Q.29 Cricketer Ravi Shastri represented the _____ team in the Ranji Trophy tournament.

- Ans
- 1. Karnataka
 - 2. Delhi
 - 3. Calcutta
 - 4. Mumbai

Q.30 Consider the following statements with respect to the meaning of privatisation.

- (i) Non-transfer of ownership of public sector enterprises to the entrepreneurs in the private sector.
 - (ii) Transfer of Management of public sector enterprises to the entrepreneurs in the private sector.
- Choose the correct answer.

- Ans
- 1. Both (i) and (ii) are true
 - 2. Both (i) and (ii) are false
 - 3. Only (i) is true
 - 4. Only (ii) is true

Q.31 Which of the following was a drama based on the love story of King Dushyanta, written by Kalidasa during the Gupta period?

- Ans
- 1. Kumarasambhava
 - 2. Raghuvamsa
 - 3. Vikramorvashi
 - 4. Abhijnanashakuntala

Q.32 IK Gujral, one of the former PMs of India, has written which of the following autobiographies?

- Ans
- 1. From Corridors of Power
 - 2. Matters of Discretion
 - 3. Living History
 - 4. My Times

Q.33 The famous jewelled throne, popularly known as the Peacock throne, was commissioned by _____.

- Ans
- 1. Akbar
 - 2. Aurangzeb
 - 3. Humayun
 - 4. Shah Jahan

Q.34 Which of the following is an example of double displacement reaction?

- Ans
- 1. $2\text{Pb}(\text{NO}_3)_2 (\text{s}) + \text{Heat} \rightarrow 2\text{PbO} (\text{s}) + 4\text{NO}_2 (\text{g}) + \text{O}_2 (\text{g})$
 - 2. $\text{ZnO} + \text{C} \rightarrow \text{Zn} + \text{CO}$
 - 3. $\text{Fe} (\text{s}) + \text{CuSO}_4 (\text{aq}) \rightarrow \text{FeSO}_4 (\text{aq}) + \text{Cu} (\text{s})$
 - 4. $\text{Na}_2\text{SO}_4 (\text{aq}) + \text{BaCl}_2 (\text{aq}) \rightarrow \text{BaSO}_4 (\text{s}) + 2\text{NaCl} (\text{aq})$

Q.35 Which Article of the Indian Constitution mentions that it shall be the obligation of the State to protect every monument or place or object of artistic or historic interest?

- Ans
- 1. Article 49
 - 2. Article 51
 - 3. Article 45
 - 4. Article 47

Q.36 Which of the following pairs is INCORRECT?

- Ans
- 1. Third Five-Year Plan – Gadgil Yojana
 - 2. Fourth Five-Year Plan – Garibi Hatao target
 - 3. First Five-Year Plan – Agricultural development
 - 4. Second Five-Year Plan – Nehru Mahalanobis model

Q.37 The Geological Survey of India (GSI) was set up in 1851 primarily to find coal deposits for _____.

- Ans
- 1. export to Japan
 - 2. textile mills
 - 3. railways
 - 4. marine transport

Q.38 The voting age was reduced from 21 years to 18 years by the _____ Constitutional Amendment Act of 1988.

- Ans
- 1. 61st
 - 2. 71st
 - 3. 51st
 - 4. 41st

Q.39 Which of the following is the darkest, or least reflective object in the Solar System with an albedo of 0.03?

- Ans
- 1. 9P/Tempel 1
 - 2. 1P/Halley
 - 3. 2P/Encke
 - 4. 19P/Borrelly

Q.40 Karaikudi R Mani is India's renowned player of the _____.

- Ans
- 1. sitar
 - 2. mridangam
 - 3. santoor
 - 4. violin

Q.41 Which liberal Viceroy enacted local self-government for municipalities and repealed the unpopular Vernacular Press Act of 1878?

- Ans
- 1. Lord Lytton
 - 2. Lord Ripon
 - 3. Lord Dufferin
 - 4. Lord Ilbert

Q.42 Which of the following players won the Major Dhyan Chand Khel Ratna Award in Hockey in 2021?

- Ans
- 1. Sumit Antil
 - 2. Ravi Kumar Dahiya
 - 3. PR Sreejesh
 - 4. Lovlina Borgohain

Q.43 In the context of external debt, what do ECBs stands for?

- Ans
- 1. External Common Borrowings
 - 2. Essential Commercial Borrowings
 - 3. External Commercial Borrowings
 - 4. Essential Common Borrowings

Q.44 Srimanta Sankar Dev is associated with which of these dance forms?

- Ans
- 1. Kathak
 - 2. Manipuri
 - 3. Sattriya
 - 4. Odissi

Q.45 What percentage of people were below the poverty line in India in 2011-2012 as per the Economic Survey 2013-14, released by the Ministry of Finance, Government of India?

- Ans
- 1. 21.9%
 - 2. 18.7%
 - 3. 10.2%
 - 4. 12.4%

Q.46 Bihu festival is majorly celebrated in which of these states?

- Ans
- 1. Maharashtra
 - 2. Goa
 - 3. Assam
 - 4. Kerala

Q.47 Which of the following measures of the money supply is also known as the 'aggregate monetary resources of the

- Ans
- 1. M2
 - 2. M4
 - 3. M3
 - 4. M1

Q.48 Which of the following is a part of the earth's interior?

- Ans
- 1. Troposphere
 - 2. Thermosphere
 - 3. Stratosphere
 - 4. Asthenosphere

Q.49 Who among the following is NOT associated with 'Prarthana Samaj', a reformist society established in 1867?

- Ans
- 1. Govind Ranade
 - 2. RG Bhandarkar
 - 3. Atmaram Pandurang
 - 4. Bal Gangadhar Tilak

Q.50 Which of the following Schedules of the Constitution of India have immunity from Judicial Review?

- Ans
- 1. 4th
 - 2. 10th
 - 3. 9th
 - 4. 6th

Section : Reasoning

Q.1 Select the correct combination of mathematical signs to sequentially replace the * signs and to balance the given equation.
 $65 * 81 * 9 * 10 * 8 * 8$

- Ans
- 1. $\div + - \times =$
 - 2. $+ - \div \times =$
 - 3. $+ \div - = \times$
 - 4. $+ \div - \times =$

Q.2 Select the correct mirror image of the given combination when the mirror is placed at MN as shown below.



- Ans
- 1. F c d 7 4 k n
 - 2. F c 7 d 4 k n
 - 3. F c 7 q 4 k n
 - 4. F c 7 d 4 k n

Q.3 Which figure should replace the question mark (?) if the series were to be continued?

S		2		T		S		
△	X	2	O	S	X	E	2	S
	P	O		△	P		O	△
								△
								E
								O
								?

Ans

✗ 1.

7		
↑	E	T
	O	2

✗ 2.

2		
O	7	T
	↑	△

✗ 3.

2		
O	S	T
	△	E

✓ 4.

7		
↑	S	T
	△	E

Q.4 Which of the following option figures will complete the pattern in the figure given below?



Ans



Prepare 50% Faster

Q.5 A square sheet of paper is folded along the dotted line successively along the directions shown and is then punched last. How would the paper look when unfolded?

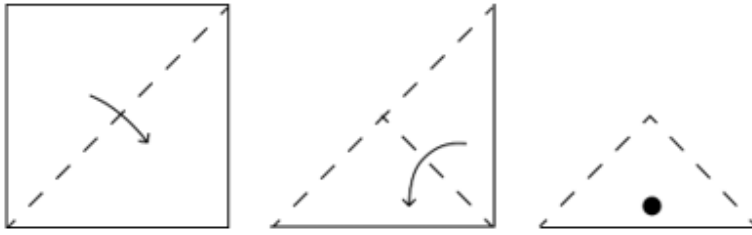

Ans

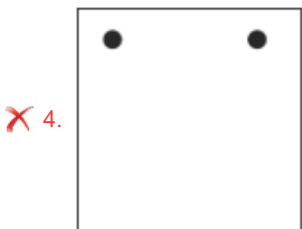
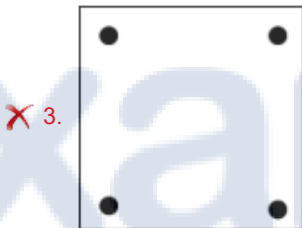
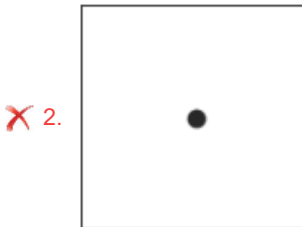
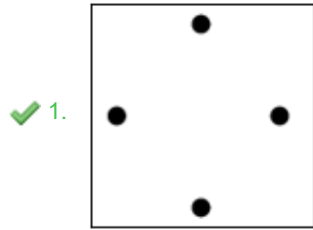

Q.6 Select the option that is related to the fourth number in the same way as the first number is related to the second number and the fifth number is related to the sixth number.
311 : 1244 :: ? : 1760 :: 531 : 2124

- Ans
- ✓ 1. 440
 - ✗ 2. 395
 - ✗ 3. 352
 - ✗ 4. 410

Q.7 Two statements are given followed by two conclusions numbered I and II. Assuming the statements to be true, even if they seem to be at variance from commonly known facts, decide which of the conclusions logically follow(s) from the statements.

Statements:

Some Baskets are Cakes.

Some Cakes are Tarts.

Conclusions:

I. Some Cakes are Baskets.

II. Some Tarts are Cakes.

- Ans
- ✗ 1. Only conclusion I follows.
 - ✗ 2. Only conclusion II follows.
 - ✓ 3. Both conclusions I and II follow.
 - ✗ 4. Neither conclusion I nor II follows.

Q.8 Select the figure from the options that can replace the question mark (?) complete the given pattern.

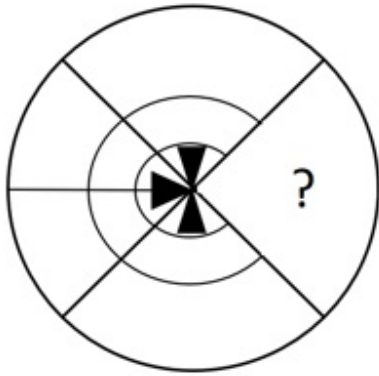

Ans

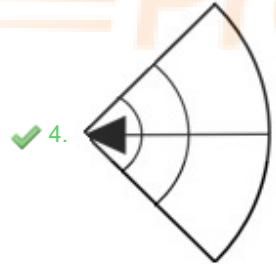
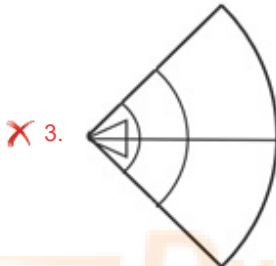
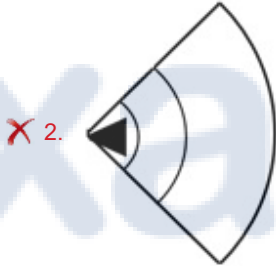
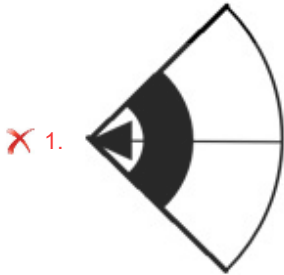

Q.9 The sequence of folding a piece of paper and the manner in which the folded paper is cut is shown in the following figures. How would this paper look when unfolded?

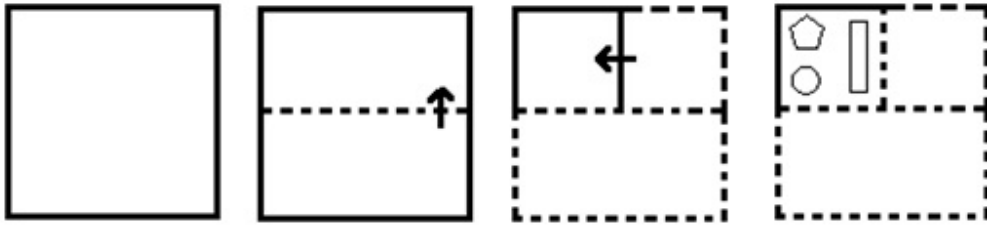

Ans

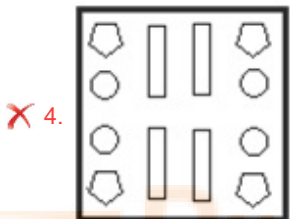
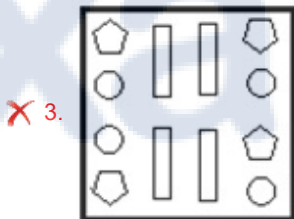
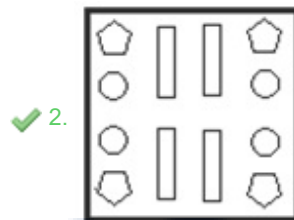
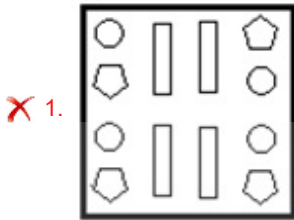

Q.10 A paper is folded and cut as shown below. How will it appear when unfolded?

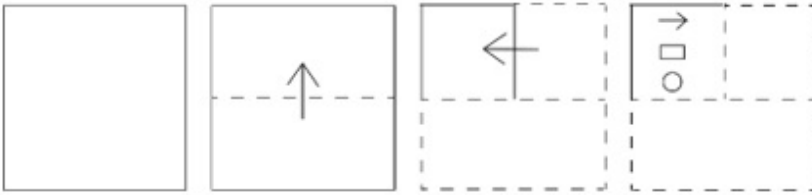

Ans

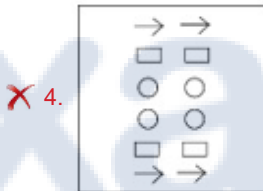
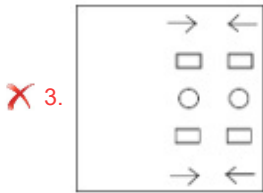
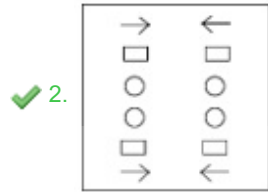
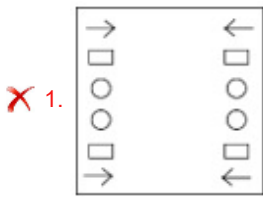

Q.11 In a certain code, if 15-20-17-2-7-0-18-5 denotes PURCHASE and 14-17-3-4-18 denotes ORDER, then what does 15-17-14-2-4-18-19 denote?

- Ans
- ✗ 1. PACKETS
 - ✓ 2. PROCESS
 - ✗ 3. ARRANGE
 - ✗ 4. PROCEED

Prepare 50% Faster

Q.12 Given below is a series of figures – A, B, C and D which follow a particular pattern. Which of the given option figure come in place of E to continue the series?

B	D	S	K	?
@	8	d	z	

(A) (B) (C) (D) (E)

Ans

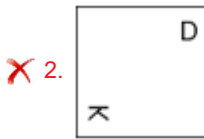

Q.13 Six letters, J, K, L, M, N and O, are written on the different faces of a dice. Two positions of this dice are shown in the given figure. Find the letter on the face opposite to M.

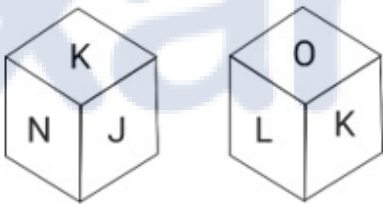

- Ans
- ✗ 1. O
 - ✗ 2. N
 - ✓ 3. K
 - ✗ 4. L

Prepare 50% Faster

Q.14 Select the correct mirror image of the given combination when the mirror is placed at 'MN' as shown below.

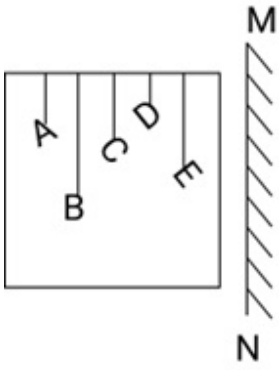

Ans

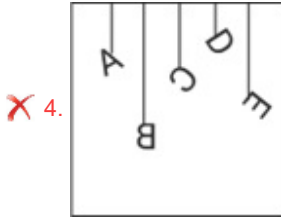
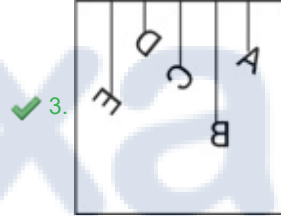
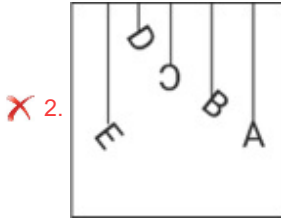
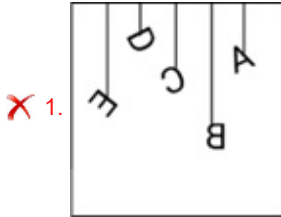

Q.15 Which two signs should be interchanged to make the given equation correct?
 $16 \div 4 + 20 \times 82 - 14 = 148$

- Ans
- ✗ 1. + and =
 - ✓ 2. + and ×
 - ✗ 3. + and -
 - ✗ 4. = and ×

Q.16 Select the option that represents the letters that, when sequentially placed from left to right in the blanks below, will complete the letter series.

D _ P _ U D N _ T _ _ _ P T U D _ _ T U

- Ans
- ✗ 1. TNUPDNNP
 - ✓ 2. NTPUDNNP
 - ✗ 3. NTUPNDPN
 - ✗ 4. TNPUNDPN

Q.17 Which of the following option figures will complete the pattern in the figure given below?



Ans

X 1.



✓ 2.



X 3.

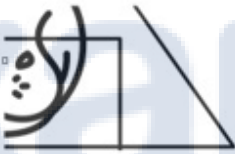

X 4.

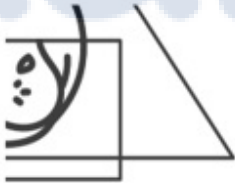

Prepare 50% Faster

Q.18 Select the option figure which is embedded in the given figure as its part (rotation is NOT

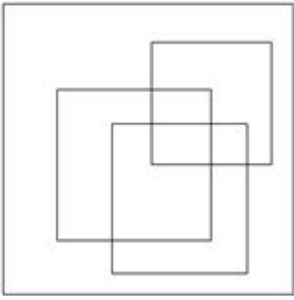

Ans

X 1.

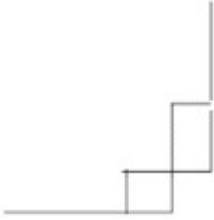

X 2.

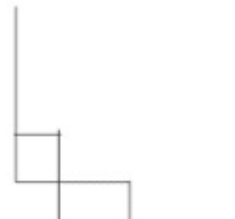

X 3.



✓ 4.



Q.19 Select a figure from amongst the four given options which, when placed in the blank space of figure (X), would complete the pattern.

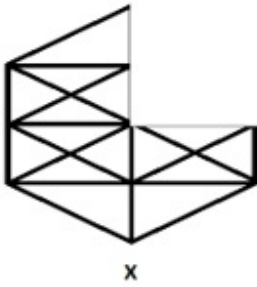

Ans

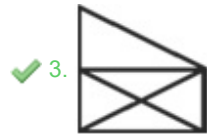
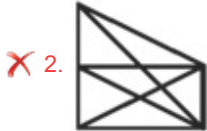

Q.20 Select the set in which the numbers are related in the same way as are the numbers of the following sets.
(NOTE: Operations should be performed on the whole numbers, without breaking down the numbers into its constituent digits. E.g., 13 – Operations on 13 such as adding/deleting/multiplying etc. to 13 can be performed. Breaking down 13 into 1 and 3 and then performing mathematical operations on 1 and 3 is not allowed)
(13, 5, 87)
(17, 6, 115)

- Ans
- ✗ 1. (9, 4, 6)
 - ✓ 2. (25, 8, 171)
 - ✗ 3. (21, 7, 153)
 - ✗ 4. (29, 9, 207)

Q.21 Six persons U, V, W, X, Y, Z are sitting in a circle facing each other. V is between X and W. U is between Y and W. Z is to the immediate right of X. Who is the immediate neighbour of both U and Z?

- Ans
- ✓ 1. Y
 - ✗ 2. W
 - ✗ 3. X
 - ✗ 4. V

Q.22 Select the number from among the given options that can replace the question mark (?) in the following series.

30, 45, 75, 135, 255, ?

- Ans
- ✓ 1. 495
 - ✗ 2. 568
 - ✗ 3. 430
 - ✗ 4. 634

Q.23 How many triangles are there in the given figure?

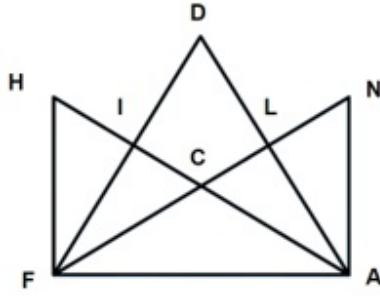

- Ans
- ✓ 1. 14
 - ✗ 2. 19
 - ✗ 3. 25
 - ✗ 4. 11

Q.24 Select the figure from among the given options that can replace the question mark (?) in the following series.

T R	□ E	V ☆	B R	
N E	V S	N R	□ S	N ☆
				?

- Ans
- ✗ 1.

●	□
N	B
S	☆
 - ✓ 2.

□	●
N	B
☆	S
 - ✗ 3.

●	S
N	□
☆	R
 - ✗ 4.

□	R
N	B
☆	S

Q.25 Select the option that is related to the fifth letter-cluster in the same way as the second letter-cluster is related to the first letter-cluster and the fourth letter-cluster is related to the third letter-cluster.
INCH : EKAG :: INKS : EKIR :: IDOL : ?

- Ans
- ✗ 1. EANJ
 - ✓ 2. EAMK
 - ✗ 3. DAML
 - ✗ 4. EANK

Q.1 The ratio of the number of boys to that of the girls in a school is 9 : 13. If the total number of boys and girls in the school is 2134, what is the number of boys in that school?

- Ans
- 1. 873
 - 2. 855
 - 3. 882
 - 4. 891

Q.2 Which of the following numbers is greater than the sum of all the prime factors of 1560?

- Ans
- 1. 22
 - 2. 23
 - 3. 21
 - 4. 41

Q.3 The marked price of a table lamp is ₹1,500. If the marked price is 20% above the cost price and the table lamp is sold at a discount of 10%, then find the profit percentage.

- Ans
- 1. 9%
 - 2. 10%
 - 3. 7%
 - 4. 8%

Q.4 The price of a computer is ₹34,000. What will be the price of the computer (in ₹) after a reduction of 17%?

- Ans
- 1. 26,200
 - 2. 30,500
 - 3. 28,220
 - 4. 27,380

Q.5 A garrison of 1500 men has provisions for 12 days. How long will the provisions last if the garrison is increased to 2000 men?

- Ans
- 1. 6 days
 - 2. 12 days
 - 3. 9 days
 - 4. 10 days

Q.6 What is the difference between the total surface area and the curved area of a hemisphere having a diameter of 14 cm? (Use $\pi = \frac{22}{7}$)

- Ans
- 1. 148 cm^2
 - 2. 180 cm^2
 - 3. 154 cm^2
 - 4. 108 cm^2

Q.7 Kajal goes to school on her bicycle. If she moves 4 km/h faster, she reaches the school 3 minutes before the scheduled time, if she moves 2 km/h slower, she reaches the school 2 minutes after the scheduled time. What is the distance (in km) of the school from her home?

- Ans
- 1. 4
 - 2. 6
 - 3. 8
 - 4. 3

Q.8 The simple interest on ₹24,000 at a certain rate of interest for 3 years is ₹7,200. What will be the compound interest(compounded annually) on the same sum at the same rate and for the same time?

- Ans
- 1. ₹7,854
 - 2. ₹7,954
 - 3. ₹7,845
 - 4. ₹7,944

Q.9 The LCM of two numbers is 18 times their HCF. The sum of the LCM and HCF is 855. If one number is 81, then what is the other number?

- Ans
- 1. 440
 - 2. 458
 - 3. 450
 - 4. 448

Q.10 The average height of 16 students of a group is 160 cm. If the average height of the first 6 students in the group is 150 cm and those of the last 8 students is 165 cm, then find the average height of the remaining two students, in cm.

- Ans
- 1. 340
 - 2. 260
 - 3. 150
 - 4. 170

Q.11 Simplify $(0.85 \times 3.4 \times 2.4) \div 0.3$.

- Ans
- 1. 23.12
 - 2. 23.02
 - 3. 24.34
 - 4. 24.04

Q.12 Ram takes a loan of ₹30,000 from Kishan on 20% simple interest. He agrees to clear the loan, along with the interest, in four equal instalments, each at the end of 1 year, for 4 years. However, Kishan puts forward a condition that he will continue to calculate the interest on the original amount lent till Ram completely pays off his loan. What will be the value of each instalment?

- Ans
- 1. ₹11,500
 - 2. ₹12,450
 - 3. ₹13,000
 - 4. ₹13,500

Q.13 Aman bought two chairs for ₹1,800. He sold the first chair at a 12% profit and the second one at a 20% profit. Had he sold the first chair at a 20% profit and the second one at a 12% profit, he would have received ₹36 more. Find the difference between the cost-price of the two chairs.

- Ans
- 1. ₹450
 - 2. ₹675
 - 3. ₹650
 - 4. ₹525

Q.14 The radius of a sphere is 1.65 cm. Find the exact surface area (in cm^2) of this sphere.

- Ans
- 1. 10.69π
 - 2. 10.89π
 - 3. 10.99π
 - 4. 10.79π

Q.15 The salaries of P and Q together amount to ₹4,32,000. P and Q spend 75% and 61% of their salaries, respectively. savings are equal, then what is P's salary?

- Ans**
- 1. ₹2,36,250
 - 2. ₹2,36,750
 - 3. ₹2,63,750
 - 4. ₹2,63,250

Section : Computer Proficiency

Q.1 Which of the following is NOT a characteristic of communication on the internet?

- Ans**
- 1. It is interactive.
 - 2. It is global.
 - 3. It is asynchronous.
 - 4. It is always private.

Q.2 In MS Excel 365, if you set a row height to 0 (zero), what happens to the row?

- Ans**
- 1. It returns to the last entered value.
 - 2. It asks for a new value.
 - 3. It sets the default height.
 - 4. It hides the row.

Q.3 Which action in MS-Word 365, allows you to remove selected text from its original location and place it on the clipboard?

- Ans**
- 1. Select All
 - 2. Copy
 - 3. Cut
 - 4. Paste

Q.4 Which of the following is the shortcut key to Paste text in MS Word 365?

- Ans**
- 1. Shift+V
 - 2. Ctrl+V
 - 3. Ctrl+Shift+V
 - 4. Ctrl+C

Q.5 Which of the following statements related to attaching a file to an email is correct?

- Ans**
- 1. We can't use CC field while sending an attachment.
 - 2. Writing a subject field is mandatory while sending an attachment.
 - 3. In Gmail, If your file is greater than 25 MB, Gmail automatically adds a Google Drive link in the email instead of including it as an attachment.
 - 4. We can't attach an audio file in an email attachment.

Q.6 In Microsoft Excel 365, which of the following functions is used for displaying the current date?

- Ans**
- 1. Today()
 - 2. Now()
 - 3. Day()
 - 4. Time()

Q.7 When we press the control key with the letter E, what happens to the text in the MS-Word 365?

- Ans**
- 1. Left aligns the contents on the page.
 - 2. Right aligns the contents on the page.
 - 3. Centers the contents on the page.
 - 4. It selects the whole content on the file.

Q.8 In MS-Word 365, which option allows you to customize various aspects of a document's layout, such as paper size, orientation, and page numbering?

- Ans**
- 1. Document Inspector
 - 2. Navigation Pane
 - 3. Page Setup
 - 4. Print Layout View

Q.9 In MS Excel 365, what is the keyboard shortcut to automatically adjust the width of a column to fit the content in Excel?

- Ans**
- 1. ALT + H then O and then I
 - 2. Ctrl + Spacebar
 - 3. Ctrl + W
 - 4. Ctrl + A

Q.10 Which of the following is NOT a common method of opening a document in a web-based document editor like Google Docs?

- Ans**
- 1. Creating a new document from a template
 - 2. Uploading the document from your computer
 - 3. Typing the entire document from scratch
 - 4. Importing a document from a web link

ixamBee

Prepare 50% Faster

Constable Executive Male and Female in Delhi Police Examination 2023

Exam Date	30/11/2023
Exam Time	9:00 AM - 10:30 AM
Subject	Constable Executive Male and Female in Delhi Police Examination 2023

Section : General Knowledge

Q.1 According to the 2011 Census, the literacy rate among females in India is _____ compared to males.

- Ans**
- 1. higher
 - 2. lower
 - 3. unpredictable
 - 4. equal

Q.2 Bhajan Sopori is associated with which of the following instruments?

- Ans**
- 1. Santoor
 - 2. Sarod
 - 3. Violin
 - 4. Been

Q.3 With which of the following states is the 'Popir' dance associated?

- Ans**
- 1. Arunachal Pradesh
 - 2. Madhya Pradesh
 - 3. Jharkhand
 - 4. Chhattisgarh

Q.4 Who among the following wrote 'Nirmala'?

- Ans**
- 1. Shrilal Shukla
 - 2. Munshi Premchand
 - 3. Ramdhari Singh
 - 4. Jaishankar Prasad

Q.5 Which of the following countries is the winner of the FIFA Football World Cup 2022?

- Ans**
- 1. Argentina
 - 2. England
 - 3. Japan
 - 4. Brazil

Q.6 The horizontal distance between two adjacent crests or troughs is known as the _____.

- Ans**
- 1. wave length
 - 2. wave frequency
 - 3. wave period
 - 4. wave speed

Q.7 Which edition of the FIFA U-17 Women's World Cup was hosted by India in 2022?

- Ans
- 1. Fifth
 - 2. Sixth
 - 3. Fourth
 - 4. Seventh

Q.8 Which of the following Articles of the Indian Constitution is related with equal justice and free legal aid?

- Ans
- 1. Article 43 A
 - 2. Article 39 A
 - 3. Article 48 A
 - 4. Article 51 A

Q.9 'Koman' and 'Kuruwa' are the names of _____ in India.

- Ans
- 1. artificial lakes
 - 2. slash and burn agriculture
 - 3. tribes of Himalaya
 - 4. peaks of Western Ghats

Q.10 From which country is the legislative procedure in the Indian Constitution taken from?

- Ans
- 1. Ireland
 - 2. Australia
 - 3. Japan
 - 4. United Kingdom

Q.11 Majority of India's foreign trade is carried out by which means of transportation?

- Ans
- 1. Rail transportation
 - 2. Sea transportation
 - 3. Air transportation
 - 4. Road transportation

Q.12 The capital of Satakarni I of the Satavahanas was _____.

- Ans
- 1. Anahilapatan
 - 2. Anahilapura
 - 3. Prabhas Patan
 - 4. Pratisthana

Q.13 The Ramakrishna Mission was founded by _____ to regenerate Indian society by promoting the Vedanta philosophy.

- Ans
- 1. Swami Vivekananda
 - 2. Raja Ram Mohan Roy
 - 3. Swami Dayananda Saraswati
 - 4. Debendranath Tagore

Q.14 सर्वोच्च न्यायालय के क्षेत्राधिकार की गारंटी निम्नलिखित में से किसके द्वारा दी जाती है?

- Ans
- 1. मुख्य न्यायाधीश
 - 2. राष्ट्रपति
 - 3. संसद
 - 4. संविधान

- Q.15** Which of the following were NOT part of the comprehensive liberalisation reforms introduced in July 1991?
- Ans**
- 1. Financial sector reforms
 - 2. Demographic reforms
 - 3. Trade and capital flow reforms
 - 4. Disinvestment and public enterprise reforms

- Q.16** The inscription in Sanskrit, recording the repairing of the Mauryan dam at Junagarh belonged to whom among the following?
- Ans**
- 1. Rudradaman
 - 2. Gautamiputra Satakarni
 - 3. Kanishka
 - 4. Menander

- Q.17** Which of the following is the function of trade barriers?
- Ans**
- 1. Restrict the flow of Indian goods and services in India
 - 2. Restrict packed goods
 - 3. Restrict the flow of international goods and services
 - 4. Ban making goods

- Q.18** Match the diseases in group I with the modes of transmission in group II.

Group I		Group II	
(a)	Meningitis	(i)	inoculation into skin or mucosa
(b)	Rabies	(ii)	contaminated food or water
(c)	Typhoid	(iii)	contact with soil
(d)	Tetanus	(iv)	droplet infection

- Ans**
- 1. (a)-(iv), (b)-(i), (c)-(iii), (d)-(ii)
 - 2. (a)-(ii), (b)-(i), (c)-(iv), (d)-(iii)
 - 3. (a)-(i), (b)-(iv), (c)-(ii), (d)-(iii)
 - 4. (a)-(iv), (b)-(i), (c)-(ii), (d)-(iii)

- Q.19** Which of the following is known as the power house of cells?
- Ans**
- 1. Cytoplasm
 - 2. Ribosomes
 - 3. Mitochondria
 - 4. Nucleus

- Q.20** Who among the following has the power to make provision as he/she may think fit for the discharge of the functions of the Governor of a State in any contingency?
- Ans**
- 1. Prime Minister
 - 2. Chief Justice of the High Court
 - 3. President
 - 4. Chief Justice of India

- Q.21** Lai Haraoba, which literally means 'the festival of gods', is primarily celebrated in which state of India?
- Ans**
- 1. Kerala
 - 2. Uttarakhand
 - 3. Manipur
 - 4. Himachal Pradesh

Q.22 Annapurna Finance Private Limited had its origin as a not-for-profit company called _____, an NGO that hel women in Odisha.

- Ans
- 1. Alternative for Rural Movement
 - 2. Peoples Forum
 - 3. All India Development Trust
 - 4. Action for Rural Transformation

Q.23 The first Battle of Panipat was fought on 20 April 1526 between Babur and _____.

- Ans
- 1. Bahlul Lodi
 - 2. Ibrahim Lodi
 - 3. Mahmud Lodi
 - 4. Sikandar Lodi

Q.24 Which of the following rivers is also known as 'Dakshin Ganga'?

- Ans
- 1. Mahanadi River
 - 2. Godavari River
 - 3. Pranhita River
 - 4. Bhargavi River

Q.25 'The Story of My Experiments with Truth' is an autobiography of _____.

- Ans
- 1. Jawaharlal Nehru
 - 2. Bhimrao Ambedkar
 - 3. Sardar Vallabhbhai Patel
 - 4. Mahatma Gandhi

Q.26 Who among the following, as Indian slide instrumentalist, vocalist and composer, initiated the Planet Symphony Orchestra in 2019?

- Ans
- 1. Mohan Kannon
 - 2. Rahul Ram
 - 3. Abhay Jodhpurkar
 - 4. Narasimhan Ravikiran

Q.27 From which Five-Year Plan period was the formulation and implementation of the Five-Year Plan discontinued by the Government of India?

- Ans
- 1. Ninth Five-Year Plan
 - 2. Tenth Five-Year Plan
 - 3. Twelfth Five-Year Plan
 - 4. Eleventh Five-Year Plan

Q.28 Which festival is celebrated to commemorate the birth anniversary of Lord Buddha?

- Ans
- 1. Kathina
 - 2. Parinirvana Day
 - 3. Vesak
 - 4. Ullambana

Q.29 Which of the following statements about water resource is correct?

- Ans
- 1. Water is a biotic resource.
 - 2. Water is both, biotic and abiotic resource.
 - 3. Water is a cyclic resource.
 - 4. Water is a non-renewable resource.

Q.30 Which Article of the Indian Constitution restricts and prohibits religious instructions in the educational institutions are maintained by the Government and funded by the government?

- Ans**
- 1. Article 25
 - 2. Article 29
 - 3. Article 23
 - 4. Article 28

Q.31 Bhagat Singh and _____ threw a bomb in the Central Legislative Assembly on 8 April 1929.

- Ans**
- 1. Sukhdev Thapar
 - 2. Jaidev Kapoor
 - 3. Shivaram Rajguru
 - 4. Batukeshwar Dutt

Q.32 How many of the main fixed instruments can be found in the Jantar Mantar, Jaipur?

- Ans**
- 1. 20
 - 2. 17
 - 3. 15
 - 4. 25

Q.33 Fundamental duties were first added by which Constitutional Amendment Act?

- Ans**
- 1. 48th Constitutional Amendment Act
 - 2. 44th Constitutional Amendment Act
 - 3. 42nd Constitutional Amendment Act
 - 4. 46th Constitutional Amendment Act

Q.34 Irregular growth of teeth is due to the deficiencies of vitamin _____.

- Ans**
- 1. D
 - 2. K
 - 3. A
 - 4. B

Q.35 In which year did Mihir Sen create history by being the only man to swim the five oceans in one calendar year?

- Ans**
- 1. 1950
 - 2. 1966
 - 3. 1958
 - 4. 1949

Q.36 हनुक्का एक _____ त्यौहार है।

- Ans**
- 1. जैन
 - 2. यहूदी
 - 3. सिख
 - 4. बौद्ध

Q.37 In which of the following sessions did the Indian National Congress decide to boycott the Simon Commission?

- Ans**
- 1. Bombay session
 - 2. Allahabad session
 - 3. Madras session
 - 4. Poona session

Q.38 Veeranatyam is an ancient form of dance from which of these states?

- Ans
- 1. Uttar Pradesh
 - 2. Andhra Pradesh
 - 3. Rajasthan
 - 4. Punjab

Q.39 On which of the following matters of the State List can Delhi's Legislature make laws?

- Ans
- 1. Police
 - 2. Land
 - 3. Health
 - 4. Public order

Q.40 In 1991, India met with an economic crisis where the _____ reserves fell so low that they were not sufficient for even a _____.

- Ans
- 1. gold; year
 - 2. gold; month
 - 3. foreign exchange; fortnight
 - 4. foreign exchange; quarter

Q.41 Suppose a person has four acres of land in India, and he actually needs only two workers and himself to carry out various operations on his farm in a year, but if he employs five workers and his family members such as his wife and children", this situation known as _____.

- Ans
- 1. Seasonal Unemployment
 - 2. Transitional Unemployment
 - 3. Open Unemployment
 - 4. Disguised Unemployment

Q.42 According to Planning commission of India (2011-12), which group of states has the highest poverty ratio?

- Ans
- 1. Maharashtra and Gujarat
 - 2. Chhattisgarh and Jharkhand
 - 3. Punjab and Haryana
 - 4. Madhya Pradesh and Uttar Pradesh

Q.43 Which form of dance does Kumudini Lakhia perform?

- Ans
- 1. Kathak
 - 2. Bharatanatyam
 - 3. Manipuri
 - 4. Kathakali

Q.44 In an economy, if the gross national product at factor cost is ₹10,000 crores, depreciation is ₹250 crores, the net factor income from abroad is ₹500 crores, what is the value of national income?

- Ans
- 1. ₹9,250 crores
 - 2. ₹10,750 crores
 - 3. ₹10,250 crores
 - 4. ₹9,750 crores

Q.45 In the context of globalisation, FDI is an important term. What does the I stand for in FDI?

- Ans
- 1. Investment
 - 2. International
 - 3. Interest
 - 4. Investor

Q.46 Rashtrakuta ruler Dantidurga died without a male heir and was succeeded by his uncle_____.

- Ans
- 1. Krishna I
 - 2. Govinda I
 - 3. Indra I
 - 4. Amoghavarsha I

Q.47 When did the Pro Wrestling League start in India?

- Ans
- 1. 2017
 - 2. 2014
 - 3. 2010
 - 4. 2015

Q.48 Who among the following published the book 'Stripurushtulna', criticising the social differences between men and women?

- Ans
- 1. Ishwar Chandra Vidyasagar
 - 2. Vijaya Laxmi Pandit
 - 3. Tarabai Shinde
 - 4. Pandita Ramabai

Q.49 Which famous chemist refuted the theory of 'vitalism' by saying that organic substances can only be produced from living things?

- Ans
- 1. John Dalton
 - 2. Antoine Lavoisier
 - 3. Friedrich Wohler
 - 4. Marcellin Berthelot

Q.50 Kailasa temple is made up of which of the following types of rock?

- Ans
- 1. Basalt
 - 2. Marble
 - 3. Granite
 - 4. Pumice

Section : Reasoning

Q.1 Select the option that represents the letters that, when sequentially placed from left to right in the blanks below, will complete the letter series.

_ L _ O P H _ N _ P H L N _ _ H L _ O _

- Ans
- 1. HNLOOPNP
 - 2. HNOLOPPN
 - 3. NHOLOPPN
 - 4. NHLOPONP

Q.2 In a certain code language, 'JAM' is written as 'KCP' and 'MUG' is written as 'NWJ'. How will 'TEA' be written in that language?

- Ans
- 1. UFC
 - 2. UGC
 - 3. UGD
 - 4. UFB

Q.3 Select the figure from the options that can replace the question mark (?) :  Prepare 50% Faster



Ans

✗ 1.



✓ 2.



✗ 3.



✗ 4.



Q.4 Given below is a series of figures – A, B, C and D which follow a particular pattern. Which of the given option figures should come in place of E to continue the series?

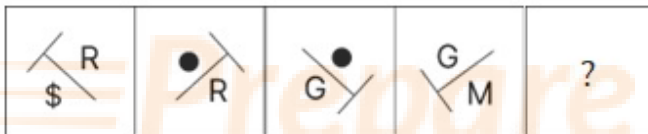

(A)

(B)

(C)

(D)

(E)

Ans

✓ 1.



✗ 2.



✗ 3.



✗ 4.



Q.5 Which of the following option figures will complete the pattern in the figure given below?



Ans

X 1.



X 2.



X 3.



✓ 4.



Q.6 Six numbers, 7, 8, 9, 10, 11 and 12 are written on different faces of a dice. Three positions of this dice are shown here. Find the number on the face opposite 11.

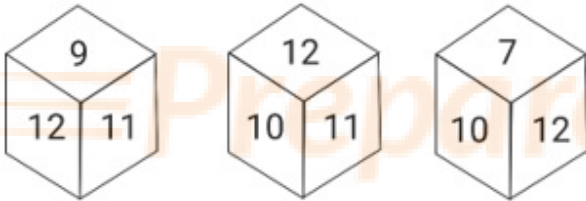

Ans

X 1. 9

X 2. 10

✓ 3. 7

X 4. 8

Q.7 How many triangles are there in the given figure?

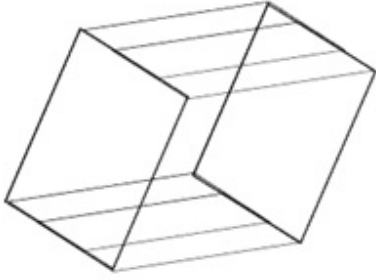

- Ans
- 1. 4
 - 2. 6
 - 3. 5
 - 4. 7

Q.8 Which of the following option figures will complete the pattern in the figure given below?



- Ans
- 1.
 - 2.
 - 3.
 - 4.

Q.9 Select the option figure which is embedded in the given figure as its part (rotation is NOT allowed).

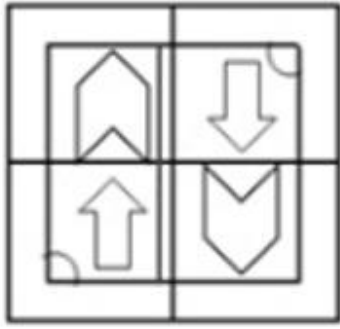

Ans

- 1.
- 2.
- 3.
- 4.

Q.10 Three different positions of the same dice are shown. Find the number on the face opposite the face having '1'.

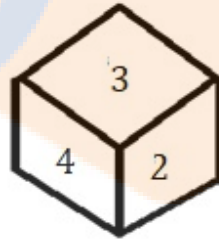
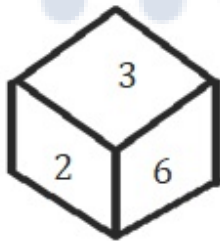
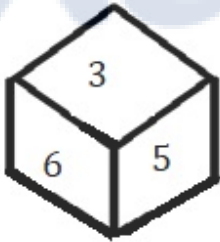

- Ans
- 1. 2
 - 2. 4
 - 3. 6
 - 4. 3

Q.11 Select the option that is related to the third word in the same way as the second word is related to the first word. (The words must be considered as meaningful English words and must NOT be related to each other based on the number of letters/number of consonants/vowels in the word)

Hot : Summer :: Cold : ?

- Ans
- 1. February
 - 2. April
 - 3. August
 - 4. Winter

Q.12 Seven kids, G, H, I, J, K, L and M, are sitting in a straight row facing north. Only two people sit to the right of H. Only three people sit between H and I. J sits to the immediate right of H and to the immediate left of G. K sits to the immediate right of L and is not a neighbour of H. Who sits second from the extreme left end of the row?

- Ans
- 1. L
 - 2. H
 - 3. I
 - 4. K

Q.13 Select the figure that will replace the question mark (?) in the following figure series.

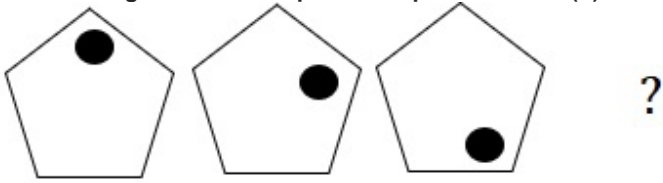

Ans

✓ 1.

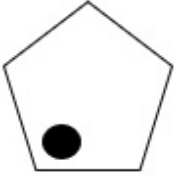

✗ 2.

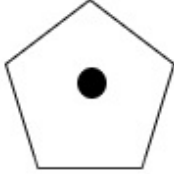

✗ 3.

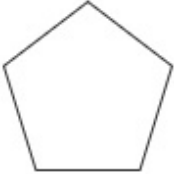

✗ 4.



ixamBee

Prepare 50% Faster

Q.14 The given figure is followed by four option figures. Select the option figure in which this figure is embedded (i.e., this figure in the same form; rotation is NOT allowed).



Ans

✓ 1.

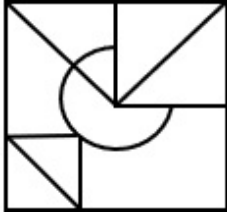

✗ 2.

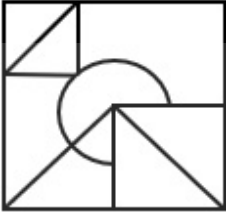

✗ 3.

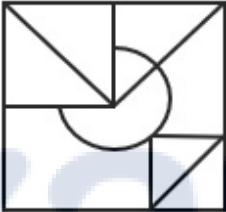

✗ 4.

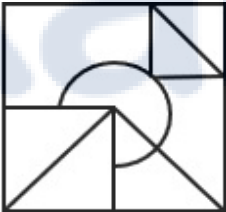

Q.15 Which figure should replace the question mark (?) if the following series were to be continued?

♥	P	K	♥	I	
P I 3 K	N 3 I ♥	♥ N 3 I	P 3 N K	K P 3 N	?
N	K	P	I	♥	

Ans

- 1.

♥
N 3 P K
I
- 2.

N
♥ 3 P I
K
- 3.

♥
N K P 3
I
- 4.

K
♥ 3 P I
N

Q.16 Select the set in which the numbers are related in the same way as are the numbers of the following sets. (NOTE : Operations should be performed on the whole numbers, without breaking down the numbers into its constituent digits. E.g. 13 – Operations on 13 such as adding /deleting /multiplying etc. to 13 can be performed. Breaking down 13 into 1 and 3 and then performing mathematical operations on 1 and 3 is NOT allowed) (6, 48), (12, 168)

- Ans
- 1. (13, 182)
 - 2. (14, 224)
 - 3. (16, 278)
 - 4. (19, 342)

Q.17 Two statements are given, followed by two conclusions numbered I and II. Assuming the statements to be true, even if they seem to be at variance with commonly known facts, decide which of the conclusions logically follow(s) from the statements.

Statements:

All houses are buildings.

Some houses are apartments.

Conclusions:

I. All buildings are houses.

II. Some buildings are apartments.

- Ans
- 1. Both Conclusions I and II follow.
 - 2. Only Conclusion I follows.
 - 3. Neither Conclusion I nor II follows.
 - 4. Only Conclusion II follows.

Q.18 A square sheet of paper is folded along the dotted line successively along the directions shown and is then punched last. How would the paper look when unfolded?

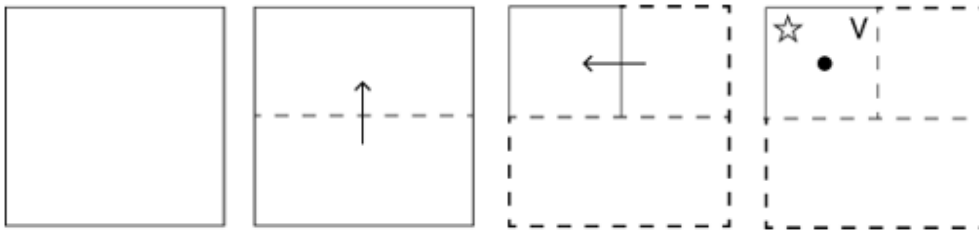

Ans

✗ 1.

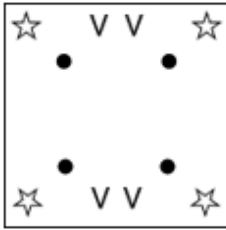

✗ 2.

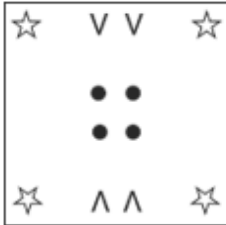

✗ 3.



✓ 4.

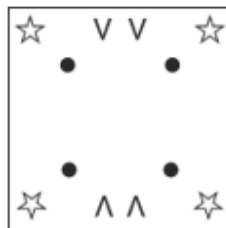

Q.19 16 is related to 24 following a certain logic. Following the same logic, 22 is related to 33. To which of the following is 36 related, following the same logic?
(NOTE: Operations should be performed on the whole numbers, without breaking down the numbers into their constituent digits. E.g. 13 – Operations on 13 such as adding/subtracting/multiplying etc. to 13 can be performed. Breaking down 13 into 1 and 3 and then performing mathematical operations on 1 and 3 is not allowed.)

- Ans
- ✗ 1. 49
 - ✗ 2. 45
 - ✗ 3. 51
 - ✓ 4. 54

Q.20 Which of the following options will replace the question mark (?) in the given series?
47, 56.4, 67.68, 81.216, ?

- Ans
- ✓ 1. 97.4592
 - ✗ 2. 9.7632
 - ✗ 3. 86.9544
 - ✗ 4. 91.3462

Q.21 Select the correct mirror image of the given combination when the mirror is placed at 'MN' as shown below.

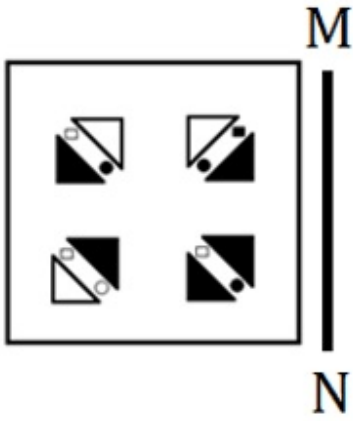

Ans

✓ 1.

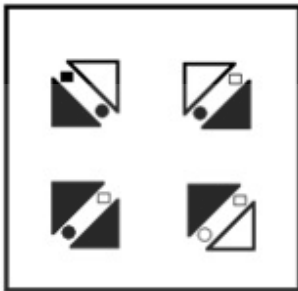

✗ 2.

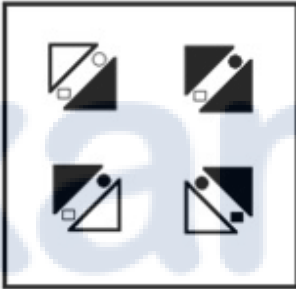

✗ 3.

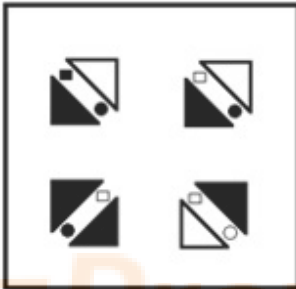

✗ 4.

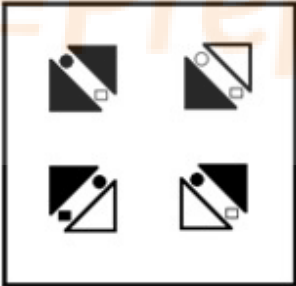

Q.22 Which of the following answer figures complete the pattern by replacing the question mark? (rotation is NOT allowed).

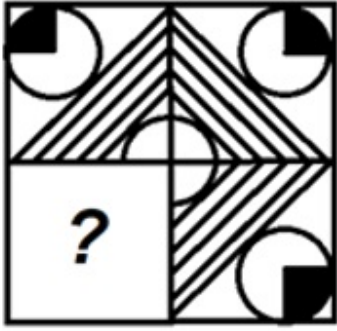

Ans

- 1.
- 2.
- 3.
- 4.

Q.23 If P denotes 'x', Q denotes '÷', R denotes '+', and S denotes '-', then what will come in place of '?' in the following equation?
 $(7)^2 R (8 Q 2) P 13 R (63 Q 7) P 8 S 41 = ?$

- 1. 128
- 2. 140
- 3. 132
- 4. 136

Prepare 50% Faster

Q.24 A paper is folded and cut as shown below. How will it appear when unfolded?

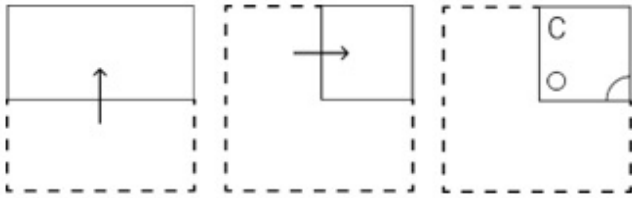

Ans

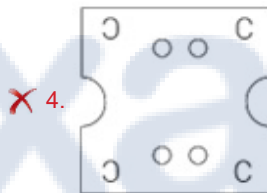
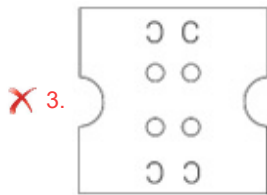
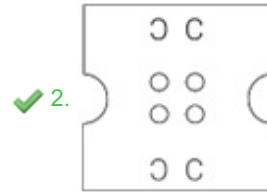
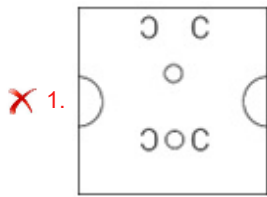

Q.25 Select the correct combination of mathematical signs that can sequentially replace the * signs and balance the given equation.

$$6 * 12 * 3 * 8 * 3 * 35$$

- Ans
- 1. $\div, -, \times, +, =$
 - 2. $+, \div, \times, -, =$
 - 3. $+, -, \times, \div, =$
 - 4. $+, \times, -, \div, =$

Section : Numerical Ability

Q.1 A missile travels at 1152 km/h. How much distance (in m) does it travel in one second?

- Ans
- 1. 340
 - 2. 380
 - 3. 360
 - 4. 320

Q.2 If $184 \div 11.5 = 16$, then $1.84 \div 1.15$ is:

- Ans
- 1. 1.06
 - 2. 0.6
 - 3. 1.6
 - 4. 0.16

Q.3 The number of all prime numbers less than 40 is:

- Ans
- 1. 10
 - 2. 11
 - 3. 13
 - 4. 12

Q.4 A table is sold for ₹5,862 with 20% profit. The gain or loss percentage (to one decimal place) if it had been sold at ₹5,000, is:

- Ans
- 1. 1.5% loss
 - 2. 2.4% profit
 - 3. 1.6% profit
 - 4. 2.3% loss

Q.5 The average of 7.012, 4.018, 6.012, 4.048, and 3.91, is:

- Ans
- 1. 3.5
 - 2. 4.5
 - 3. 5
 - 4. 7

Q.6 Ramesh sells an article at a discount of 15% of the marked price and he gains 25%. If the marked price of the article is ₹7,600, then the cost price of the article is:

- Ans
- 1. ₹5,188
 - 2. ₹5,178
 - 3. ₹5,168
 - 4. ₹5,198

Q.7 Simplify $\frac{7 \div (7 \times 7)}{(7 \div 7) \times 7}$

- Ans
- 1. 49
 - 2. 7
 - 3. 1
 - 4. $\frac{1}{49}$

Q.8 A person spends 80% of his income. His income increases by 30% and his expenditure also increases by 10%. By what percentage will his savings increase?

- Ans
- 1. 104%
 - 2. 110%
 - 3. 90%
 - 4. 98%

Q.9 A sum of money was lent at 12.5% rate of yearly compound interest for three years. If the present value (i.e. after three years) of the sum of money is ₹13,851, then how much money (in ₹) was lent?

- Ans
- 1. 8728
 - 2. 10000
 - 3. 10278
 - 4. 9728

Q.10 What is the principal on a certain sum of money at 5% per annum for $2\frac{2}{5}$ years if the amount is ₹1,120?

- Ans
- 1. ₹1,000
 - 2. ₹2,000
 - 3. ₹5,000
 - 4. ₹500

Q.11 In an election, there were three candidates: Ram, Ramesh and Ganesh. Ram received 48% votes and Ramesh received 36% votes. If the total number of votes polled was 40,000, find the number of votes received by Ganesh.

- Ans
- 1. 6900
 - 2. 7800
 - 3. 6400
 - 4. 7400

Q.12 If $x : y = 2 : 3$, $y : z = 4 : 7$ and $z : w = 7 : 3$, then $x : y : z : w$ is:

- Ans
- 1. 8 : 12 : 21 : 9
 - 2. 12 : 8 : 21 : 9
 - 3. 8 : 4 : 21 : 9
 - 4. 4 : 21 : 9 : 8

Q.13 Find the number of lead balls, each 2 cm in diameter, that can be made from a sphere of diameter 20 cm.

- Ans
- 1. 1500
 - 2. 1000
 - 3. 100
 - 4. 150

Q.14 A, B and C can do a piece of work in 40, 60 and 120 days, respectively. In how many days can A do the work if he is assisted by B and C on every third day?

- Ans
- 1. 35
 - 2. 20
 - 3. 30
 - 4. 25

Q.15 If the diameter of a solid sphere is 28 cm, its hemisphere will have curved surface area (in cm^2) of:

(Take $\pi = \frac{22}{7}$)

- Ans
- 1. 1232
 - 2. 1731
 - 3. 1764
 - 4. 1844

Section : Computer Proficiency

Q.1 Which of the following options defines the 'Clipboard' in Microsoft Word 365?

- Ans
- 1. Accessing the internet
 - 2. Creating hyperlinks
 - 3. Changing font settings
 - 4. Storing and managing copied or cut text and objects

Q.2 In MS Excel 365, Which of the following is used to open a save dialog box in MS-Excel?

- Ans**
- 1. View -> save
 - 2. File -> save
 - 3. Home -> save
 - 4. Data -> save

Q.3 Which of the following types of networking is used to connect all the computers within a school or within an office?

- Ans**
- 1. Local Area Network
 - 2. Metropolitan Area Network
 - 3. Wide Area Network
 - 4. Personal Area Network

Q.4 What is the full form of email?

- Ans**
- 1. Electro mail
 - 2. Express mail
 - 3. Electronic mail
 - 4. Efficient mail

Q.5 In Microsoft Excel 365, which type of sorting places values from smallest to largest?

- Ans**
- 1. Ascending order
 - 2. Descending order
 - 3. Random order
 - 4. Alphanumeric order

Q.6 Which of the following is used to select the entire paragraph in MS-Word 365?

- Ans**
- 1. Double-click
 - 2. Scroll
 - 3. Single-click
 - 4. Triple-click

Q.7 The keyboard shortcut _____ is used to create bullets in MS Word 2010.

- Ans**
- 1. Ctrl + Alt + B
 - 2. Ctrl + Alt + L
 - 3. Ctrl + Shift + B
 - 4. Ctrl + Shift + L

Q.8 In MS Excel 365, Which option is typically used to save a new spreadsheet for the first time?

- Ans**
- 1. Save and New
 - 2. Save and Print
 - 3. Close
 - 4. Save As

Q.9 The thesaurus tool in MS word 365 is used for _____.

- Ans**
- 1. finding similar words in the document
 - 2. checking for synonyms and antonyms
 - 3. finding repeated words in the document
 - 4. checking for nouns and verbs

Q.10 Which of the following shortcut key is used to convert the selected font to subscript in MS Word 365?

- Ans
- 1. Shift + +
 - 2. Ctrl + =
 - 3. Ctrl + +
 - 4. Shift + =



 Prepare 50% Faster

Constable Executive Male and Female in Delhi Police Examination 2023

Exam Date	30/11/2023
Exam Time	12:00 PM - 1:30 PM
Subject	Constable Executive Male and Female in Delhi Police Examination 2023

Section : General Knowledge

Q.1 Who among the following Gupta emperors held the title of Vikramaditya?

- Ans**
- 1. Skandagupta
 - 2. Chandragupta II
 - 3. Budhagupta
 - 4. Chandragupta I

Q.2 In which year did India's 'National Food for Work Programme' begin?

- Ans**
- 1. 2000
 - 2. 2003
 - 3. 2004
 - 4. 2002

Q.3 The victory of the _____ marked the foundation stone of the Delhi Sultanate in India.

- Ans**
- 1. Afghans
 - 2. Turks
 - 3. Persians
 - 4. Arabs

Q.4 In which year did the Indian Badminton team create history by winning the Thomas Cup tournament?

- Ans**
- 1. 2022
 - 2. 2020
 - 3. 2019
 - 4. 2021

Q.5 Which of the following structures stores carbohydrates?

- Ans**
- 1. Elaioplast
 - 2. Amyloplast
 - 3. Chloroplast
 - 4. Aleuroplast

Q.6 Man became a food producer from which period in history?

- Ans**
- 1. Mesolithic Age
 - 2. Palaeolithic Age
 - 3. Chalcolithic Age
 - 4. Neolithic Age

Q.7 The Statue of Unity is located at the bank of which of these rivers?

- Ans**
- 1. Ganga
 - 2. Krishna
 - 3. Narmada
 - 4. Yamuna

Q.8 In the game of javelin throw the weight of Javelin for women is:

- Ans**
- 1. 600 gm
 - 2. 825 gm
 - 3. 800 gm
 - 4. 700 gm

Q.9 How many gold medals has the Indian Hockey team won in the Olympics till 2023?

- Ans**
- 1. 11
 - 2. 10
 - 3. 7
 - 4. 8

Q.10 Which of the following sections of the Constitution of India has been referred to as 'Conscience of the Indian Constitution'?

- Ans**
- 1. Centre-State relationship
 - 2. Citizenship
 - 3. Fundamental Rights
 - 4. Fundamental Duties

Q.11 Which Article of the Constitution of India debar the courts to inquire into the proceedings of the State Legislature?

- Ans**
- 1. Article 212
 - 2. Article 209
 - 3. Article 211
 - 4. Article 210

Q.12 With reference to the travellers who visited India, who among the following was from Portugal?

- Ans**
- 1. François Bernier
 - 2. Duarte Barbosa
 - 3. Ibn Batuta
 - 4. Nicolo Conti

Q.13 The virgin vegetation, which are purely Indian are termed as endemic or indigenous species, while those that have come from outside India are called:

- Ans**
- 1. Non-native species
 - 2. Exotic species
 - 3. Endangered species
 - 4. Native species

Q.14 From which of the following countries has 'advisory jurisdiction of the Supreme Court' been adopted in the Constitution of India?

- Ans**
- 1. Cuba
 - 2. Germany
 - 3. Canada
 - 4. Portugal

Q.15 Which ethnic group is the largest in China, accounting for over 90% of the population?

- Ans**
- 1. Uighur
 - 2. Zhuang
 - 3. Han
 - 4. Manchu

Q.16 Consider the below mentioned statements and select the correct option with respect to the Indian folk and tribal dance forms:

- i) Matki is the folk dance of Assam.
- ii) Thang Ta is the folk dance of Manipur.
- iii) Fugdi is the folk dance of Goa.

- Ans**
- 1. Only (i) is right.
 - 2. Both (i) and (ii) are right.
 - 3. Both (ii) and (iii) are right.
 - 4. Only (ii) is right.

Q.17 Excessive use of pesticides, insecticides and inorganic fertilisers is not good for human health. This is due to the phenomena called:

- Ans**
- 1. intoxication
 - 2. biomagnification
 - 3. biotransformation
 - 4. biodilution

Q.18 The movie RRR has recently been honoured with the prestigious Golden Globe award for the Best Original Song for the track 'Natu Natu'. Who are the singers of this song?

- Ans**
- 1. KJ Yesudas and Anirudh Ravichander
 - 2. Silambarasan TR and Vineeth Sreenivasan
 - 3. Rahul Sipligunj and Kaala Bhairava
 - 4. Shankar Mahadevan and Rajesh Krishnan

Q.19 Which of the following types of patterns was followed in the Mohenjo-Daro town planning?

- Ans**
- 1. Grid
 - 2. Cylindrical
 - 3. Rectangular
 - 4. Circular

Q.20 Who among the following received the National Award for 'Best Music Direction' in September 2022 for his song 'Marange Toh Vahin Jaa Kar' in the documentary film '1232 KMs'?

- Ans**
- 1. Vishal Bharadwaj
 - 2. Amit Trivedi
 - 3. Swanand Kirkire
 - 4. Ajay Atul

Q.21 Rural Self-Employment Training Institute is an initiative of which Ministry of the Government of India?

- Ans**
- 1. Ministry of Labour and Employment
 - 2. Ministry of Rural Development
 - 3. Ministry of Finance
 - 4. Ministry of Agriculture

Q.22 Which Article of the Constitution of India mentions that the state shall make effective provision for securing public assistance in cases of unemployment, old age, sickness and disablement?

- Ans**
- 1. Article 41
 - 2. Article 39
 - 3. Article 45
 - 4. Article 47

Q.23 The All India Trade Union Congress worked for the improvement of the workers' working and living conditions. One of the main leaders of this was _____.

- Ans**
- 1. MG Ranade
 - 2. MN Roy
 - 3. Jyotirao Phule
 - 4. GB Pant

Q.24 Which of the following statements are correct regarding the tribal Festival Medaram Jathara?

- A. This is the largest tribal festival of India.
- B. This festival is celebrated by the Koya community of Telangana.
- C. This festival is celebrated once in two years in the month of 'Magha' (February) on the full moon day.

- Ans**
- 1. A and B only
 - 2. B and C only
 - 3. A and C only
 - 4. A,B and C

Q.25 Under Liberalisation in 1991, several foreign exchange reforms were initiated. In this context, which of the following is true for devaluation of domestic currency?

- Ans**
- 1. Fixing the domestic currency to all foreign currency
 - 2. Lowering the value of domestic currency in relation to foreign currency
 - 3. Lowering the value of foreign currency in relation to domestic currency
 - 4. Increasing value of domestic currency in relation to foreign currency

Q.26 Padma Bhushan and Sangeet Natak Akademi award winner Rukmini Devi Arundale was an exponent of _____.

- Ans**
- 1. Kathakali
 - 2. Bharatanatyam
 - 3. Kathak
 - 4. Sattriya

Q.27 Which Five-Year Plan was formulated by governments of two political parties?

- Ans**
- 1. Fifth Five-Year Plan
 - 2. Eighth Five-Year Plan
 - 3. Sixth Five-Year Plan
 - 4. Ninth Five-Year Plan

Q.28 Which of the following is the correct statement about the directive principles of state policy?

- Ans**
- 1. Articles 62-71 of the constitution of India deals with directive principles.
 - 2. Articles 12-35 of the constitution of India deals with directive principles.
 - 3. Articles 36-51 of the constitution of India deals with directive principles.
 - 4. Articles 52-62 of the constitution of India deals with directive principles.

Q.29 Which scheme was started in 2000 for additional central assistance to be given to states for basic services such health, primary education, rural shelter, etc.?

- Ans
- 1. Rural Employment Generation Programme
 - 2. Prime Minister Rojgar Yojana
 - 3. Swarnajayanti Gram Swarojgar Yojana
 - 4. Pradhan Mantri Gramodaya Yojana

Q.30 Which American President has written 'Dreams from My Father', an autobiography?

- Ans
- 1. John Kennedy
 - 2. George Bush
 - 3. George Washington
 - 4. Barack Obama

Q.31 Terekhol, Chapora, Mapusa, Sal, Zuari etc. are the major rivers of which state?

- Ans
- 1. Gujarat
 - 2. Chhattisgarh
 - 3. Goa
 - 4. Telangana

Q.32 Terraces that are level on opposite sides of the valley are referred to as _____ terraces.

- Ans
- 1. symmetrical
 - 2. horizontal
 - 3. triangular
 - 4. paired

Q.33 Which of these festivals commemorates the resurrection of Jesus from the dead?

- Ans
- 1. New Year
 - 2. Easter
 - 3. Good Friday
 - 4. Christmas

Q.34 The Konkan Railway line passes through which of the following groups of states?

- Ans
- 1. Madhya Pradesh, Goa and Karnataka
 - 2. Maharashtra, Goa and Telangana
 - 3. Maharashtra, Goa and Karnataka
 - 4. Maharashtra, Gujarat and Karnataka

Q.35 Surat, Navsari and Bhavnagar are known for their involvement in which industry?

- Ans
- 1. Diamond industry
 - 2. Automobile industry
 - 3. Software industry
 - 4. Iron and steel industry

Q.36 After which infamous incident of 1919 was the Hunter Commission appointed?

- Ans
- 1. Indian educational reforms
 - 2. Komagata Maru
 - 3. Kheda mill strike
 - 4. Jallianwala Bagh massacre

Q.37 The first National Winter Games were hosted by _____ .

- Ans
- 1. Auli
 - 2. Manali
 - 3. Srinagar
 - 4. Gulmarg

Q.38 Liberalisation is a part of _____ reforms.

- Ans
- 1. land
 - 2. economic
 - 3. social
 - 4. political

Q.39 Which of the following was NOT a disadvantage of the green revolution?

- Ans
- 1. It reduced India's import of food grains
 - 2. Most of the crops introduced during green revolution were intensive crops.
 - 3. It promoted extensive use of chemicals.
 - 4. High use of fertilisers and pesticides resulted in health illnesses.

Q.40 Of which state was Mirza Wajid Ali Shah the king in 1856, when it was annexed into the British Empire in India under the doctrine of lapse policy?

- Ans
- 1. Awadh
 - 2. Nagpur
 - 3. Satara
 - 4. Jhansi

Q.41 Tejan Bai, a well-known artist, is related to which of the following?

- Ans
- 1. Tippani
 - 2. Bhavai
 - 3. Kalbeliya
 - 4. Pandwani

Q.42 Who among the following was the Secretary of State of India and a member of the Cabinet Mission sent to India by the British Government in 1946?

- Ans
- 1. Lord Pethick-Lawrence
 - 2. Stafford Cripps
 - 3. Lord Irwin
 - 4. John Simon

Q.43 A 20-page autobiography, 'Waiting for a Visa', is written by _____, which is about his experiences with untouchability.

- Ans
- 1. Bhimrao Ramji Ambedkar
 - 2. Jyotiba Phule
 - 3. Mahatma Gandhi
 - 4. Gopal Krishna Gokhale

Q.44 The students in a physics lab have been asked to measure the amount of electric current in a circuit. Which device should they use?

- Ans
- 1. Voltmeter
 - 2. Ohmmeter
 - 3. Ammeter
 - 4. Altimeter

Q.45 Which of the below mentioned items are NOT the part of revenue expenditure as per government budget?

- Ans
- 1. Infrastructural Development Expenditure
 - 2. Interest payments
 - 3. Subsidies
 - 4. Salaries and Pensions

Q.46 Which of the following Constitutional Amendment Acts of the Indian Constitution facilitated the appointment of the same person as governor for two or more states?

- Ans
- 1. 8th
 - 2. 7th
 - 3. 5th
 - 4. 10th

Q.47 The Dancer Couple Dhananjayans were awarded the Rashtriya Kalidas Samman Award (2019-2020) for their contribution to which Indian dance form?

- Ans
- 1. Kathak
 - 2. Mohiniyattam
 - 3. Kuchipudi
 - 4. Bharatanatyam

Q.48 Which of the following statements is correct with respect to the Attorney General of India?

- Ans
- 1. He/She cannot participate in joint sitting of the parliament.
 - 2. He/She does not enjoy any immunity or privileges as compared to members of the parliament.
 - 3. He/She can participate in sessions of the parliament.
 - 4. He/She can vote in the Lok Sabha during the passage of confidence motion and no-confidence motion.

Q.49 Goods and services that are provided by the government to all the people and whose consumption is not rivalrous are known as:

- Ans
- 1. public goods
 - 2. final goods
 - 3. private goods
 - 4. intermediate goods

Q.50 Choose the correct group of greenhouse gases.

- Ans
- 1. CH₄, O₂, CO₂, N₂
 - 2. CH₄, O₂, CO₂, O₃
 - 3. CH₄, N₂O, CO₂, O₃
 - 4. H₂, O₂, CO₂, N₂

Section : Reasoning

Q.1 Select the number from among the given options that can replace the question mark (?) in the following series.

9, 20, 53, 152, 449, ?

- Ans
- 1. 4344
 - 2. 3146
 - 3. 4233
 - 4. 1340

Q.2 Which figure should replace the question mark (?) if the following series were to be continued?

C	O	T	T	3	↑	3	↑	T	T	O	X	O	X	T	
3		V	V		O	O		V	V		↑	↑		V	?
	↑			C			X			3			6		

Ans

✗ 1.

T	O	X
V		6
	↑	

✓ 2.

T	↑	6
V		X
		O

✗ 3.

T	V	6
X		↑
		O

✗ 4.

6	↑	O
V		X
		T

Prepare 50% Faster

Q.3 Select the option in which the given figure is embedded (rotation is NOT allowed).



Ans

✗ 1.

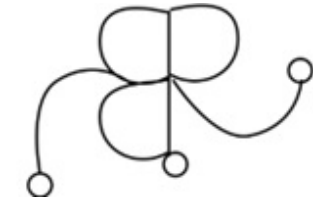

✓ 2.

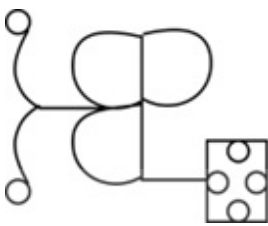

✗ 3.

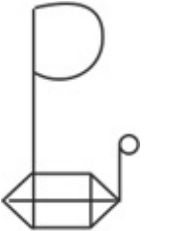

✗ 4.

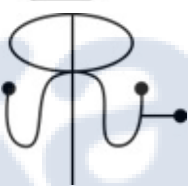

Q.4 Select the option that is related to the third word in the same way as the second word is related to the first word.
(The words must be considered as meaningful English words and must not be related to each other based on the number of letters / number of consonants / vowels in the word)
Editor : Newspaper :: Dramatist : ?

- Ans
- ✓ 1. Play
 - ✗ 2. Create
 - ✗ 3. Role
 - ✗ 4. Design

Prepare 50% Faster

Q.5 Select the option in which the given figure is embedded (rotation is NOT allowed).

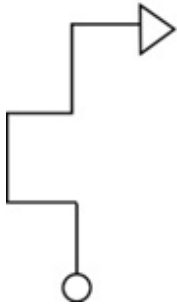

Ans

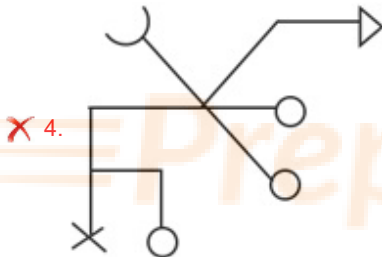
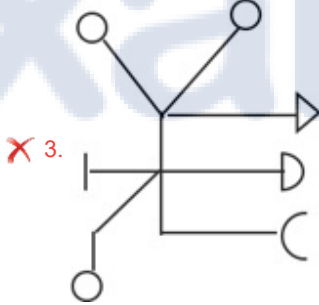
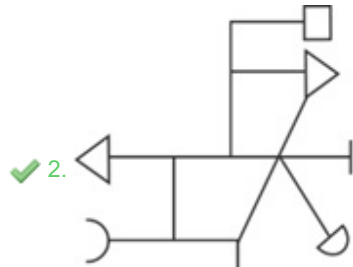
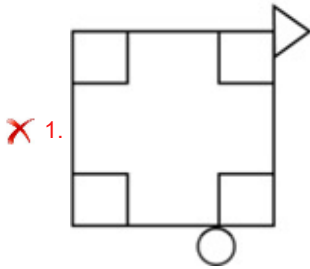

Q.6 Six dogs - P, Q, R, S, T and U - were sitting around a circular table, equidistant to one another. They were facing the centre of the table. Q was exactly between P and S. U was to the immediate right of R. T was to the immediate left of S. Who among the following was sitting third to the left of S?

- Ans
- ✗ 1. P
 - ✗ 2. U
 - ✓ 3. R
 - ✗ 4. Q

Q.7 Select the option in which the given figure is embedded (rotation is NOT allowed).

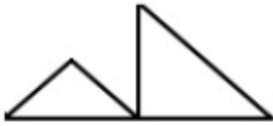

Ans

1.

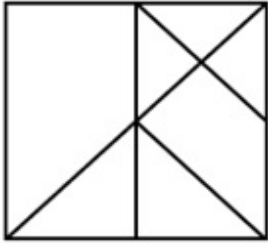

2.

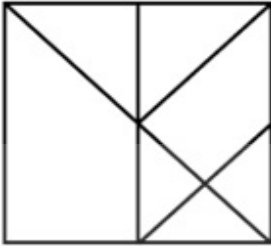

3.

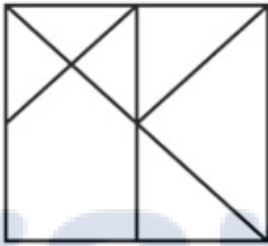

4.



Q.8 How many triangles are there in the given figure?

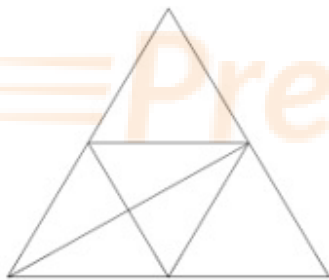

Ans 1. 14

2. 12

3. 11

4. 13

Q.9 Select the option figure that will replace the question mark (?) in the figure given below to complete the pattern.

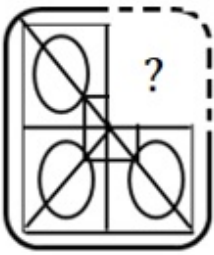

Ans

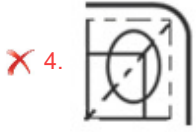
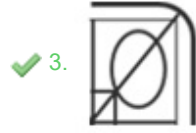
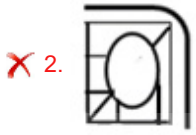
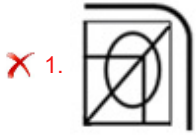

Q.10 Select the figure from the given options that will replace the question mark (?) in the figure given below and complete the pattern.

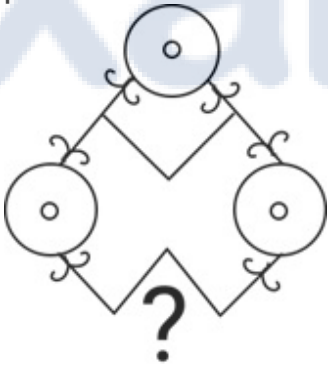

Ans

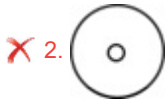

Q.11 Which figure should replace the question mark (?) if the following series were to be continued?

U	↓	∩	→	→	∩	↑	∩	∩	∩
Z		♡		B		S		3	
T	D	←	∩	∩	←	∩	∩	↑	∩

Ans

✗ 1.

∩	↑
	0
∩	D

✗ 2.

U	↓
	3
T	D

✗ 3.

U	↓
	0
T	D

✓ 4.

∩	→
	0
T	D

Prepare 50% Faster

Q.12 The sequence of folding a piece of paper and the manner in which the folded paper is cut are shown in the following. How would this paper look when unfolded?

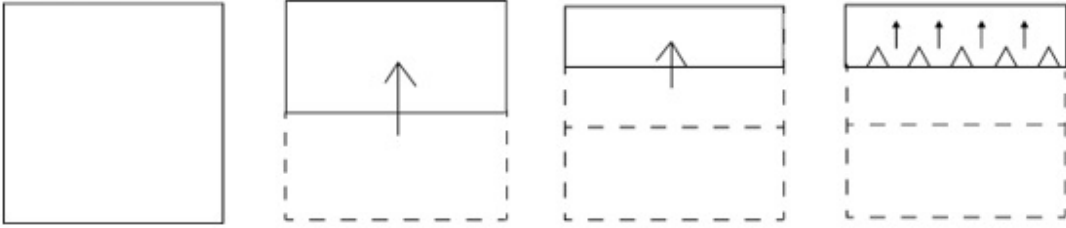

Ans

✗ 1.

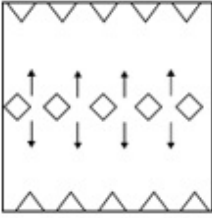

✓ 2.

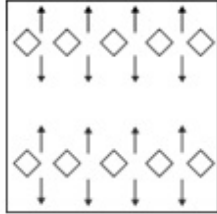

✗ 3.

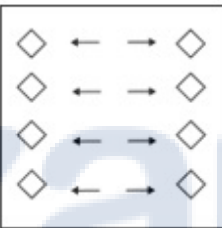

✗ 4.

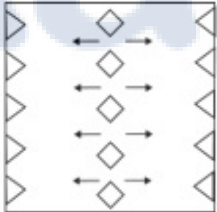

Prepare 50% Faster

Q.13 A square sheet of paper is folded along the dotted line successively along the directions shown and is then punched last. How would the paper look when unfolded?

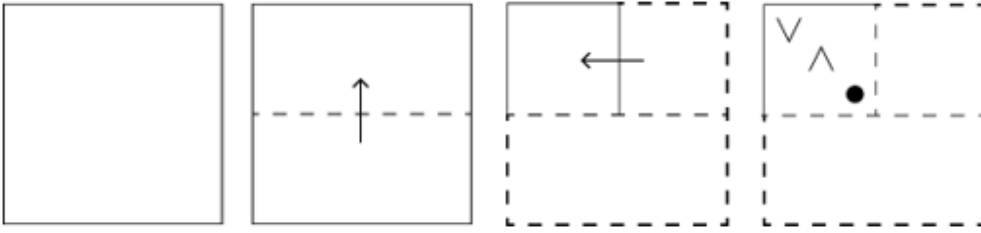

Ans

X 1.

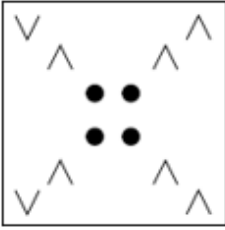

X 2.



✓ 3.



X 4.

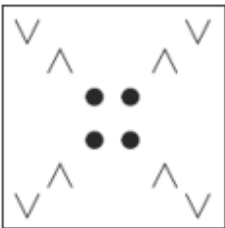

Q.14 Select the figure from among the given options that can replace the question mark (?) in the following series.

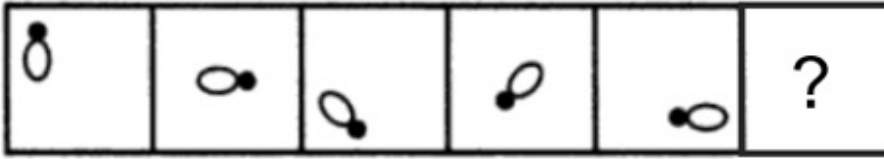

Ans

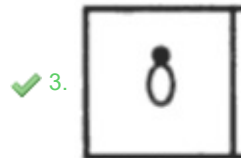
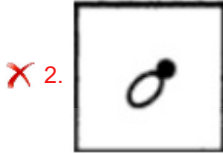
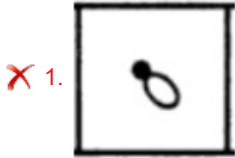

Q.15 Select the set in which the numbers are related in the same way as are the numbers of the following sets.

(NOTE : Operations should be performed on the whole numbers, without breaking down the numbers into its constituent digits. E.g. 13 – Operations on 13 such as adding /deleting /multiplying etc. to 13 can be performed. Breaking down 13 into 1 and 3 and then performing mathematical operations on 1 and 3 is not allowed.)

(40, 8, 24)
(60, 12, 36)

- Ans
- ✗ 1. (70, 14, 44)
 - ✗ 2. (80, 14, 44)
 - ✓ 3. (70, 14, 42)
 - ✗ 4. (80, 14, 42)

Q.16 Select the figure from the options that can replace the question mark (?) and complete the given pattern.

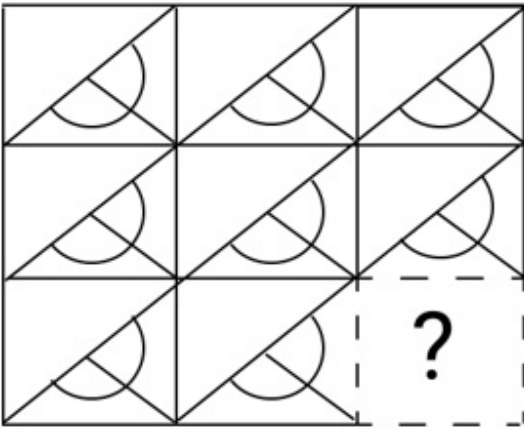

Ans

- 1.
- 2.
- 3.
- 4.

Q.17 Which two signs should be interchanged to make the following equation correct?

$$59 - 44 \div 11 \times 13 + 2 = 81$$

- 1. - and \times
- 2. + and +
- 3. + and \times
- 4. + and -

Q.18 Six letters A, B, C, P, Q and R are written on different faces of a dice. Two positions of this dice are shown in the figure. Find the letter on the face opposite to A.

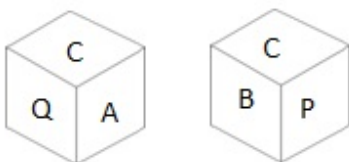

- 1. P
- 2. R
- 3. B
- 4. Q

Q.19 Two statements are given followed by two conclusions numbered I and II. Assuming the statements to be true, even if they seem to be at variance from commonly known facts, decide which of the conclusions logically follow(s) from the statements.

Statements:

All Peanuts are Almonds.

All Almonds are Butters.

Conclusions:

I. All Butters are Almonds.

II. All Peanuts are Butters.

- Ans
- 1. Both conclusions I and II follow.
 - 2. Only conclusion I follows.
 - 3. Only conclusion II follows.
 - 4. Neither conclusion I nor II follows.

Q.20 Select the correct combination of mathematical signs to sequentially replace the * signs and to balance the given equation.
 $88 * 4 * 15 * 3 * 1 * 4$

- Ans
- 1. $\div - \times + =$
 - 2. $\div - = \times +$
 - 3. $- \div = \times +$
 - 4. $- = \times + \div$

Q.21 Which of the following terms will replace the question mark (?) in the given series?
 YXQM, UUOL, QRMK, MOKJ, ?

- Ans
- 1. ILII
 - 2. OLJI
 - 3. NKII
 - 4. INJI

Q.22 In a certain code language, 'SENSE' is written as 'GUPGU' and 'PAINT' is written as 'VPKCR'. How will 'KNIFE' be written in that language?

- Ans
- 1. GHOMK
 - 2. GHKPM
 - 3. MOKHG
 - 4. GHMPK

Q.23 Select the correct mirror image of the given combination when the mirror is placed at 'XY' as shown below.

C J R Q 7 5 1 R

X
|
Y

- Ans
- 1. R 1 5 7 Q R J C
 - 2. B T 2 1 0 B 1 C
 - 3. R 1 5 7 Q R J C
 - 4. R 1 5 7 Q R J C

Q.24 A paper is folded and cut as shown below. How will it appear when unfolded?

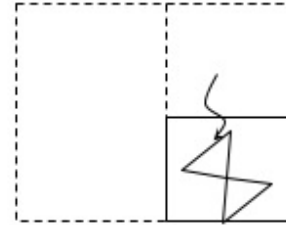
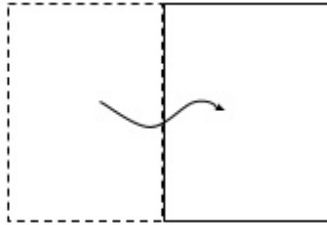

Ans

1.

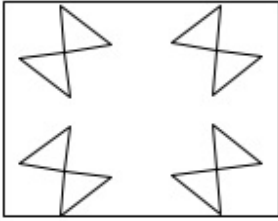

2.

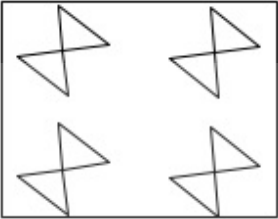

3.

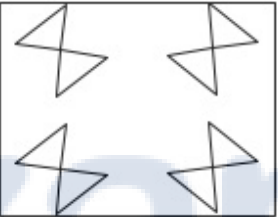

4.

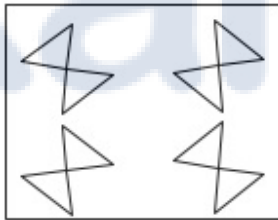

Q.25 Select the option that is related to the third term in the same way as the second term is related to the first term and the sixth term is related to the fifth term.

8 : 17 :: 14 : ? :: 20 : 41

Ans 1. 53

2. 29

3. 44

4. 30

Section : Numerical Ability

Q.1 What is the average of the numbers 15, 27, 34 and 48?

Ans 1. 31

2. 33

3. 29

4. 32

Q.2 The sum of the radius of the base and the height of a solid cylinder is 42 m. If the total surface area of the cylinder is 3696 m^2 , then find its volume.

(Where $\pi = \frac{22}{7}$)

- Ans
- 1. 16445 m^3
 - 2. 18258 m^3
 - 3. 17248 m^3
 - 4. 19240 m^3

Q.3 A shopkeeper gains 35% after allowing a discount of 15% on the marked price of an article. Find his profit per cent if the articles are sold at a marked price allowing no discount.

- Ans
- 1. 60%
 - 2. 65%
 - 3. 58.82%
 - 4. 62%

Q.4 Ritika is riding her motorcycle at a speed of 84 km/h. How many metres will Ritika cover in 45 seconds if she rides at the same speed?

- Ans
- 1. 1050
 - 2. 1035
 - 3. 1020
 - 4. 1080

Q.5 Ankit is twice as old as Reena, while Reena is three times older than Sanjana. What is the ratio of the ages of Ankit, Reena and Sanjana?

- Ans
- 1. 2:1:3
 - 2. 8:4:3
 - 3. 1:3:6
 - 4. 6:3:1

Q.6 The length of the rectangle is increased by 5% and its breadth is decreased by 5%. The area of the new rectangle is:

- Ans
- 1. decreased by 0.25%
 - 2. neither increased nor decreased
 - 3. decreased by 1%
 - 4. increased by 0.25%

Q.7 Meena has ₹20,000 in her savings account. If she spends ₹6,000, what is the decrease in saving as a percentage?

- Ans
- 1. 22%
 - 2. 12%
 - 3. 20%
 - 4. 30%

Q.8 P, Q, R and S are four prime numbers such that their sum equals 45. If it is given that $P < Q < R < S$; then the value of $P^4 + 2P$ is:

- Ans
- 1. 220
 - 2. 87
 - 3. 635
 - 4. 20

Q.9 The population of a village is 8,00,865. If it increases at the rate of 11% per annum, then what was the population village 2 years ago?

- Ans
- 1. 4,50,000
 - 2. 6,50,000
 - 3. 8,65,000
 - 4. 5,65,000

Q.10 Mr. Singh invests (Simple interest) a sum of ₹1,264 at 5% p.a. in a bank. What is the amount that he will get after 3 years?

- Ans
- 1. ₹2,145.80
 - 2. ₹1,848.80
 - 3. ₹1,453.60
 - 4. ₹1,285.80

Q.11 The sum of two numbers is 72 and their difference is $\frac{1}{9}$ of their sum. Their LCM is:

- Ans
- 1. 120
 - 2. 160
 - 3. 8
 - 4. 320

Q.12 If 56 workers earn ₹4,050 in 5 days, how much will 48 workers earn in 14 days?

- Ans
- 1. ₹6,128
 - 2. ₹9,720
 - 3. ₹5,968
 - 4. ₹9,980

Q.13 To wrap a cylinder from all sides, the cloth required to cover the curved area is double the cloth required to cover the flat areas. What is the ratio of the height of the cylinder to the radius of the cylinder?

- Ans
- 1. $1 : \sqrt{2}$
 - 2. $2 : 1$
 - 3. $\sqrt{2} : 1$
 - 4. $1 : 2$

Q.14 If $x = 0.35$ and $y = \frac{6}{5}$, then the value of $x \times y \div (100x - 30y) \times \left(\frac{y}{2.1}\right) + \frac{6}{y}$ is _____.

- Ans
- 1. 4.76
 - 2. 4.67
 - 3. 6.47
 - 4. 7.46

Q.15 A man sold two cupboards for ₹650 each, gaining 30% on one and losing 20% on the other. Had he sold the two cupboards for ₹875 each, his net gain/loss percentage (rounded off to the nearest integer) is:

- Ans
- 1. 35% profit
 - 2. 33% profit
 - 3. 42% loss
 - 4. 36% loss

Q.1 In Microsoft Word 365, what does the 'B' icon usually represent?

- Ans**
- 1. Bullet points
 - 2. Page break
 - 3. Bold formatting
 - 4. Italic formatting

Q.2 In the process of composing a new email, where is the usual location for entering the primary recipient's email address?

- Ans**
- 1. Subject line
 - 2. 'To' field
 - 3. 'CC' field
 - 4. Body of the email

Q.3 In MS Excel 365, which of the following is the correct shortcut key used to paste data in MS Excel?

- Ans**
- 1. Ctrl + V
 - 2. Alt + V
 - 3. Shift + V
 - 4. Ctrl + C

Q.4 Which of the following icons are a part of the Design menu in MS Word 365?

- Ans**
- 1. Icons to change themes, colours, fonts, effects and page borders
 - 2. Icons for spelling and grammar check, thesaurus and word count
 - 3. Icons for zooming in and out, print layout, switching windows and splitting windows
 - 4. Icons to change font size, style, alignment and borders

Q.5 Among the following, under which tab will you find the Bullets and Numbering in MS-Word 365?

- Ans**
- 1. Page Layout
 - 2. Insert
 - 3. References
 - 4. Home

Q.6 What is the purpose of sorting data in Microsoft Excel 365?

- Ans**
- 1. To apply formatting to the cells only
 - 2. To calculate averages of the data
 - 3. To organise data in a specific order based on values
 - 4. To create charts and graphs

Q.7 Which keyboard shortcut is commonly used to create a new blank document in MS Word 365?

- Ans**
- 1. Ctrl + C
 - 2. Ctrl + N
 - 3. Ctrl + S
 - 4. Ctrl + O

Q.8 Which of the following keyboard shortcuts helps you copy data in MS Excel 365?

- Ans**
- 1. Ctrl + C
 - 2. Ctrl + Z
 - 3. Ctrl + X
 - 4. Ctrl + Y

Q.9 Which option in the context menu allows you to paste the copied text with formatting removed in Microsoft Word

Ans 1. Paste

2. Paste as Plain Text

3. Paste Special

4. Paste as Unformatted Text

Q.10 What does 'ISP' stand for in the context of internet access?

Ans 1. Internet Service Provider

2. International Security Protocol

3. Internet System Protocol

4. Internet Security Program



Prepare 50% Faster

Constable Executive Male and Female in Delhi Police Examination 2023

Exam Date	30/11/2023
Exam Time	3:00 PM - 4:30 PM
Subject	Constable Executive Male and Female in Delhi Police Examination 2023

Section : General Knowledge

Q.1 In the Eleventh Five-Year Plan, the Planning Commission targeted reducing the gender gap in literacy to _____ percentage points by 2011-2012.

- Ans**
- 1. 30
 - 2. 20
 - 3. 40
 - 4. 10

Q.2 What is the ornate mountain-like entrance gateway before entering the premises of temples located in South India called?

- Ans**
- 1. Garbagriha
 - 2. Jagati
 - 3. Kalasha
 - 4. Gopuram

Q.3 The fifth Khelo India Youth Games was hosted by _____.

- Ans**
- 1. Madhya Pradesh
 - 2. Maharashtra
 - 3. Haryana
 - 4. Punjab

Q.4 MK Saroja, a Padma Shri awardee, is known for which form of dance?

- Ans**
- 1. Kathak
 - 2. Kathakali
 - 3. Garba
 - 4. Bharatnatyam

Q.5 Which of the following Harappan structures had a thin lining of bitumen to prevent the seepage of water ?

- Ans**
- 1. Granaries
 - 2. Roads
 - 3. Great Bath
 - 4. Drainage

Q.6 Which musical instrument does Gulam Ahmed, who hails from Uttar Pradesh and has made contributions in the field of art, play apart from Sarod?

- Ans**
- 1. Zirbaghali
 - 2. Doyra
 - 3. Afghani Ghichak
 - 4. Afghani Rabab

Q.7 In a food chain, the base of energy pyramid consists of:

- Ans
- 1. secondary consumers
 - 2. producers
 - 3. tertiary consumers
 - 4. primary consumers

Q.8 Who wrote the novel 'Vanity Fair'?

- Ans
- 1. William Thackeray
 - 2. Charles Dickens
 - 3. George Eliot
 - 4. Lewis Carroll

Q.9 Who among the following social reformers developed the modern Bengali Alphabet in British India?

- Ans
- 1. Keshab Chandra Sen
 - 2. Ishwar Chandra Vidyasagar
 - 3. Rabindra Nath Tagore
 - 4. Bankim Chandra Chatterjee

Q.10 In which Budget was Disinvestment Fund and Asset Management Company set up?

- Ans
- 1. 2003-04
 - 2. 2000-01
 - 3. 1992-93
 - 4. 1991-92

Q.11 निम्नलिखित में से किस देश से भारत ने 'विधि द्वारा स्थापित प्रक्रिया' को अपनाया?

- Ans
- 1. ब्राजील
 - 2. जापान
 - 3. अमेरिका
 - 4. श्रीलंका

Q.12 The Nizam Shahi dynasty of Ahmednagar was founded by _____ in 1490.

- Ans
- 1. Malik Ahmed Nizamul Mulk Bahri
 - 2. Alauddin Bahman Shah
 - 3. Mohammed Shah I
 - 4. Tajuddin Firuz Shah

Q.13 The Chief Minister of Delhi is appointed by the _____.

- Ans
- 1. Lieutenant Governor
 - 2. Governor
 - 3. President of India
 - 4. Prime Minister

Q.14 India topped the medals tally in the International Shooting Sport Federation (ISSF) World Cup-2022, which was held in Cairo, Egypt from _____.

- Ans
- 1. 12 January 2022 to 22 January 2022
 - 2. 5 June 2022 to 15 June 2022
 - 3. 10 April 2022 to 19 April 2022
 - 4. 26 February 2022 to 8 March 2022

Q.15 In the northern hemisphere, summer solstice occurs on:

- Ans**
- 1. 21st March
 - 2. 21st May
 - 3. 21st June
 - 4. 21st April

Q.16 Who of the following Chola rulers initially occupied the northern part of Sri Lanka in his raids?

- Ans**
- 1. Rajaraja I
 - 2. Rajadhiraja I
 - 3. Rajendra I
 - 4. Parantaka I

Q.17 Which is the lengthiest written Constitution in the world?

- Ans**
- 1. French Constitution
 - 2. US Constitution
 - 3. Indian Constitution
 - 4. British Constitution

Q.18 Who founded the Satya Shodhak Samaj ?

- Ans**
- 1. Jyotirao Phule
 - 2. BR Ambedkar
 - 3. Narayan Guru
 - 4. CN Annadurai

Q.19 Which of the following elements is present in common table salt?

- Ans**
- 1. Calcium
 - 2. Copper
 - 3. Magnesium
 - 4. Sodium

Q.20 According to the Census of India 2011, which Union Territory recorded the lowest literacy rate?

- Ans**
- 1. Daman and Diu
 - 2. Puducherry
 - 3. Lakshadweep
 - 4. Dadra and Nagar Haveli

Q.21 In which year was the National Rural Health Mission launched in India to provide accessible, affordable and quality health care to the rural population?

- Ans**
- 1. 2010
 - 2. 2001
 - 3. 2005
 - 4. 2007

Q.22 In 1953, who among the following dancers was called to perform for the coronation festivities of Queen Elizabeth (II)?

- Ans**
- 1. Sonal Mansingh
 - 2. Shovana Narayan
 - 3. Kumari Kamala
 - 4. Mrinalini Sarabhai

Q.23 According to Census 2011, which union territory of India has the lowest population?

- Ans
- 1. Dadra and Nagar Haveli
 - 2. Puducherry
 - 3. Lakshadweep
 - 4. Daman and Diu

Q.24 Which letter code of Köppen climate characterises a hot-summer humid continental climate?

- Ans
- 1. Dfa
 - 2. ETf
 - 3. BSh
 - 4. Cfc

Q.25 Who is the author of the historical fiction 'Legend of Suheldev: The King Who Saved India'?

- Ans
- 1. Nandini Sengupta
 - 2. Ranjit Desai
 - 3. Amish Tripathi
 - 4. Ramchandra Guha

Q.26 The Directive Principles of State Policy resembles the 'Instrument of Instructions' enumerated in the _____.

- Ans
- 1. Government of India Act of 1942
 - 2. Government of India Act of 1909
 - 3. Government of India Act of 1919
 - 4. Government of India Act of 1935

Q.27 Which Article of the Constitution of India is associated with the protection and improvement of the environment and safeguarding of forests and wild life?

- Ans
- 1. Article 39 A
 - 2. Article 43 A
 - 3. Article 48 A
 - 4. Article 51 A

Q.28 Who among the following does NOT participate in the election of the President of India?

- Ans
- 1. Elected members of Lok Sabha
 - 2. Elected members of Rajya Sabha
 - 3. Elected members of legislative assembly
 - 4. Elected members of legislative council of state

Q.29 Under competitive assets market condition, the price of a bond must always be _____ to its present value in equilibrium.

- Ans
- 1. thrice
 - 2. equal
 - 3. twice
 - 4. half

Q.30 According to the Economic Survey 2019-20, the top five trading partners of India continue to be USA, China, UAE and _____.

a) Saudi Arabia, b) Hong Kong, c) Singapore, d) Sri Lanka

- Ans
- 1. Both A and D
 - 2. Both A and B
 - 3. Both C and D
 - 4. Both B and C

Q.31 In which of the following places is the Losar Festival celebrated?

- Ans
- 1. Nagaland
 - 2. Himachal Pradesh
 - 3. Lakshadweep
 - 4. Ladakh

Q.32 Chaupakhya Festival is celebrated in the state of _____.

- Ans
- 1. Uttarakhand
 - 2. Chhattisgarh
 - 3. Jharkhand
 - 4. Rajasthan

Q.33 Which Indian classical dance is shown in the sculptures at the ancient Konark Sun Temple?

- Ans
- 1. Kuchipudi
 - 2. Manipuri
 - 3. Odissi
 - 4. Mohiniyattam

Q.34 According to the seventh schedule of the Indian Constitution, Agriculture is in which list?

- Ans
- 1. Both Union and State List
 - 2. Concurrent list
 - 3. State list
 - 4. Union list

Q.35 What process was discovered in the early 1990s that is currently used to remove ammonia from wastewater and contributes significantly to the loss of fixed nitrogen from the oceans?

- Ans
- 1. Anammox
 - 2. Volatilisation
 - 3. Coalescence
 - 4. Pervasion

Q.36 The most common route for MNC investment is to buy up _____.

- Ans
- 1. local technology
 - 2. local resources
 - 3. excess land and factories
 - 4. local companies

Q.37 Which athlete won the gold medal in the Men's Javelin Throw F46 category at the Para Athletics World Championships 2023?

- Ans
- 1. Sumit Antil
 - 2. Khilari Sachin
 - 3. Nishad Kumar
 - 4. Ajeet Singh

Q.38 In which year did the Central Government merge the CSO and NSSO and establish NSO under the Ministry of Statistics and Programme Implementation (MoSPI)?

- Ans
- 1. 2017
 - 2. 2019
 - 3. 2016
 - 4. 2018

Q.39 The chemical name of baking soda is:

- Ans
- 1. sodium hydrogen carbonate (NaHCO_3)
 - 2. sodium citrate ($\text{Na}_3\text{C}_6\text{H}_5\text{O}_7$)
 - 3. calcium hydrogen bicarbonate (CaHCO_3)₂
 - 4. sodium carbonate (Na_2CO_3)

Q.40 Who among the following personalities is a Sangeet Natak Akademi award-winning folk dancer from Punjab?

- Ans
- 1. Mamta Chandrakar
 - 2. Balkar Singh Sidhu
 - 3. Nathoo Lal Solanki
 - 4. Ram Lal

Q.41 Which of the following is an example of eastern coast port?

- Ans
- 1. Kandla Port
 - 2. Mumbai Port
 - 3. Chennai port
 - 4. New Mangalore port

Q.42 According to their notion of kingship, many Kushana rulers adopted the title of _____.

- Ans
- 1. Devaputra
 - 2. Suryaputra
 - 3. Aryaputra
 - 4. Dhartiputra

Q.43 The 'Kalol', 'Mehsana' and 'Nawagam' oil fields are associated with which state?

- Ans
- 1. Gujarat
 - 2. Maharashtra
 - 3. Rajasthan
 - 4. Assam

Q.44 Which of the following won the highest number of gold medals in the 36th national games?

- Ans
- 1. Haryana
 - 2. Maharashtra
 - 3. Services Sports Control Board
 - 4. Punjab

Q.45 As per Article 118 of the Constitution of India, who presides over the joint sitting of the two houses?

- Ans
- 1. President
 - 2. Chairman
 - 3. Prime Minister
 - 4. Speaker

Q.46 Which of the following educational institute was established by Raja Ram Mohan Roy with the cooperation of David Hare in 1817 in Calcutta?

- Ans
- 1. Vedanta College
 - 2. Sanskrit College
 - 3. Calcutta Madrasa
 - 4. Hindu College

Q.47 WTO was formed in the year 1995 to replace which of the following institutions?

- Ans**
- 1. World Bank
 - 2. Industrial Board of Reconstruction and Development
 - 3. International Monetary Fund
 - 4. General Agreement of Trade and Tariff

Q.48 Who among the following social reformers founded the Ramakrishna Mission?

- Ans**
- 1. Swami Vrajananda
 - 2. Swami Vivekananda
 - 3. Swami Dayanand
 - 4. Swami Shradddhanand

Q.49 Faiyyaz Khan, Latafat Hussein Khan and Dinkar Kaikini are famous exponents from which of the following Gharanas?

- Ans**
- 1. Agra
 - 2. Benaras
 - 3. Patiala
 - 4. Jaipur

Q.50 Which among the following is NOT a basic attribute of Dhamma mentioned in the Ashokan edicts?

- Ans**
- 1. Compassion
 - 2. Truthfulness
 - 3. Celibacy
 - 4. Charity

Section : Reasoning

Q.1 In a certain code language, 'LAND' is written as 'BLYJ' and 'BIRD' is written as 'BPGZ'. How will 'WAIT' be written in that language?

- Ans**
- 1. YURG
 - 2. RGYU
 - 3. UYGR
 - 4. RGUY

Q.2 Select the option that represents the letters that, when sequentially placed from left to right in the blanks below, will complete the letter series.

T _ _ E S _ Y R _ S T Y _ E _ T Y _ _ S

- Ans**
- 1. YETERESE
 - 2. YRETRSRE
 - 3. YTRERSRE
 - 4. YRTERSRE

Q.3 Select the number from among the given options that can replace the question mark (?) in the following series.
1, ?, 42, 78, 127, 191

- Ans**
- 1. 21
 - 2. 16
 - 3. 15
 - 4. 17

Q.4 A paper is folded and cut as shown below. How will it appear when unfolded?

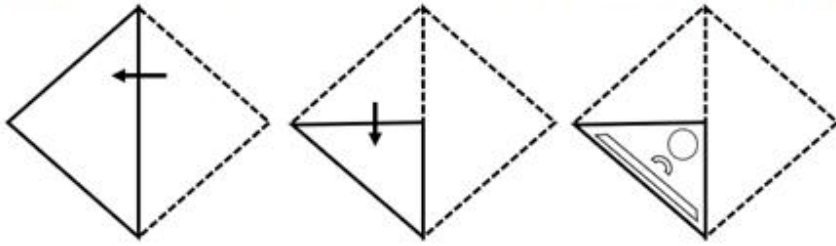

Ans

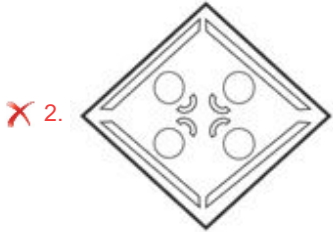
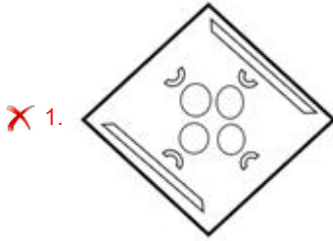

Q.5 If + means \div , - means +, \times means - and \div means \times , what is the value of the following expressions?
 $20 \div 4 - 27 + 3 \times 12 = ?$

- Ans
- ✗ 1. 80
 - ✗ 2. 79
 - ✓ 3. 77
 - ✗ 4. 75

Q.6 Two statements are given, followed by two conclusions numbered I and II. Assuming the statements to be true, even if they seem to be at variance with commonly known facts, decide which of the conclusions logically follow(s) from the statements.

Statements :

All trees are greens.

Some trees are conifers.

Conclusions:

I. All conifers are greens.

II. Some greens are trees.

- Ans
- ✗ 1. Neither Conclusion I nor II follows.
 - ✗ 2. Only Conclusion I follows.
 - ✓ 3. Only Conclusion II follows.
 - ✗ 4. Both Conclusions I and II follow.

Q.7 Select the set in which the numbers are related in the same way as are the numbers of the following sets.
(NOTE: Operations should be performed on the whole numbers, without breaking down the numbers into its constituent digits. E.g. 13 – Operations on 13 such as adding/deleting/multiplying etc. to 13 can be performed. Breaking down 13 into 1 and 3 and then performing mathematical operations on 1 and 3 is not allowed)

- Ans
- ✓ 1. (8, 11, 183)
 - ✗ 2. (7, 10, 174)
 - ✗ 3. (9, 12, 232)
 - ✗ 4. (5, 8, 86)

Q.8 Select the correct mirror image of the given figure when the mirror is placed at PQ as shown below.

(-)/(=+*&#)(X)#

P

|

Q

- Ans
- ✗ 1. #(X()#&#*+=)\(-)
 - ✓ 2. #(X)(#&#*+=)\(-)
 - ✗ 3. #(X)(#&#+*+=)\(-)
 - ✗ 4. #)X)(#&#*+=)\(-)

Q.9 Select the option that is related to the fifth letter cluster in the same way as the second letter cluster is related to the first letter cluster and the fourth letter cluster is related to the third letter cluster.
JFBW : FMXD :: KDZI : GKVP :: PRDY : ?

- Ans
- ✗ 1. LAPD
 - ✗ 2. NRHX
 - ✓ 3. LYZF
 - ✗ 4. GRUE

Prepare 50% Faster

Q.10 Select the figure from the given options that will replace the question mark (?) in the figure given below and complete the pattern.

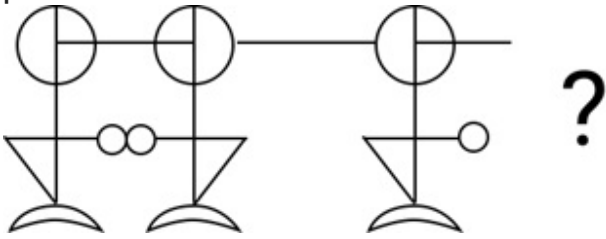

Ans

X 1.

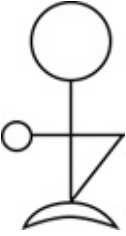

X 2.

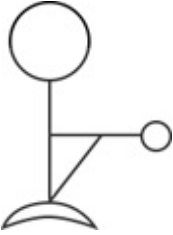

✓ 3.

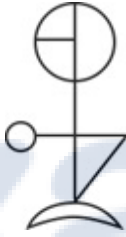

X 4.

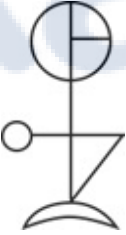

Prepare 50% Faster

Q.11 The sequence of folding a piece of paper and the manner in which the folded paper is cut is shown in the following figures. How would this paper look when unfolded?

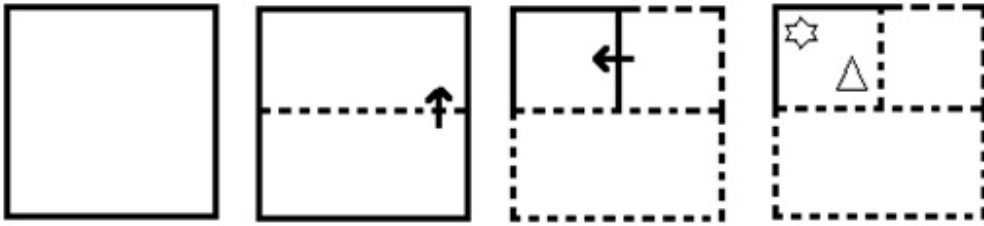

Ans

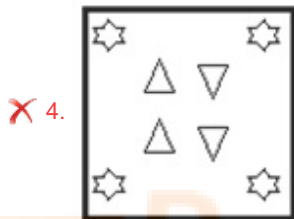
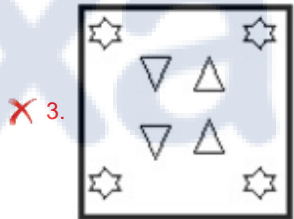
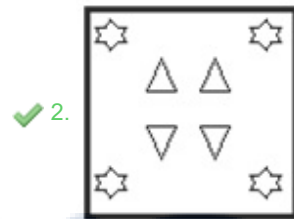
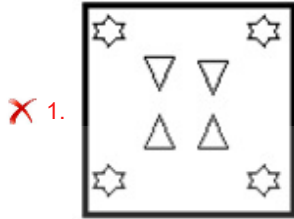

Q.12 Which of the following option figures will complete the pattern in the figure given below?



Ans

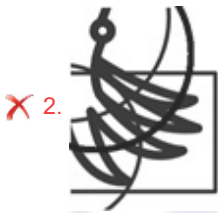

Q.13 A paper is folded and cut as shown below. How will it appear when unfolded?

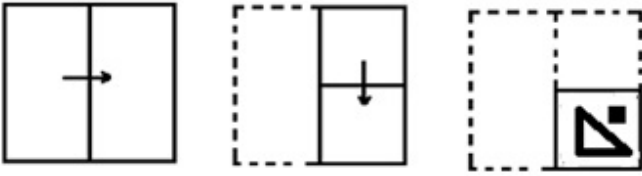

Ans

X 1.

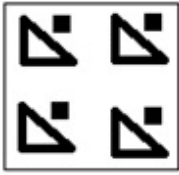

X 2.



X 3.

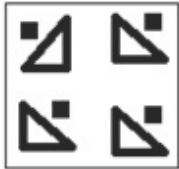

✓ 4.



Q.14 Which figure should replace the question mark (?) in the following series to continue the pattern?

2	△	0	9	9	T	2	A													
A	S	T	E	R	2	E	S	T	△	△	O	E	S	R	9	S	O	E	T	?
O	9	A	R	2	A	△	R													

Ans

✗ 1.

E	R
A	9 2 S T
△	0

✗ 2.

△	2
S	O E T 9
R	A

✓ 3.

A	E
T	2 S O R
9	△

✗ 4.

A	R
T	9 S O E
2	△

Prepare 50% Faster

Q.15 Select the figure from the given options that will replace the question mark (?) in the figure given below to complete the pattern.

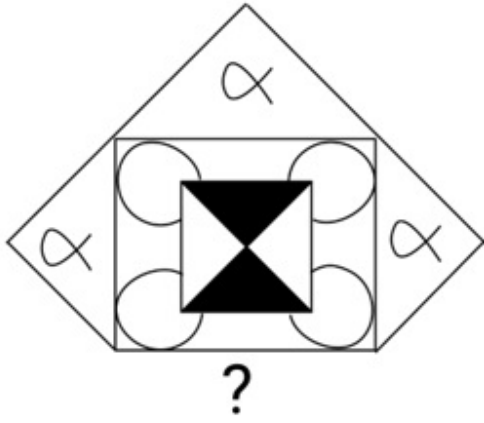

Ans

✗ 1.



✗ 2.

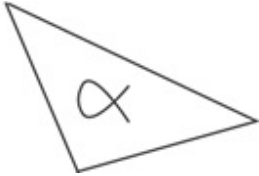

✗ 3.



✓ 4.

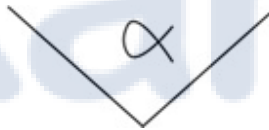

Prepare 50% Faster

Q.16 Select the figure from among the given options that can replace the question mark (?) in the following series.

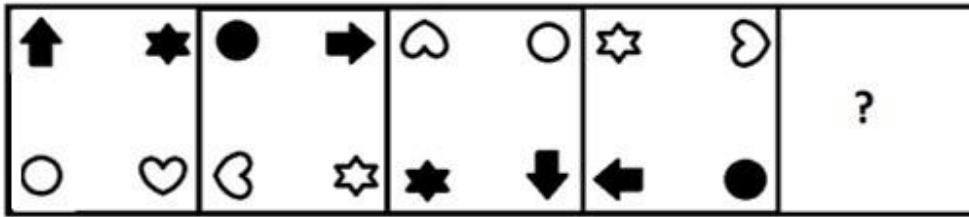

Ans

✗ 1.



✗ 2.



✗ 3.



✓ 4.

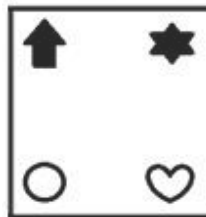

Q.17 Six letters, M, N, O, P, Q and R are written on different faces of a dice. Three positions of this dice are shown here. Find the letter on the face opposite O.

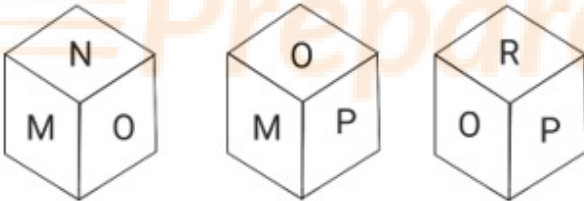

Ans

✗ 1. R

✓ 2. Q

✗ 3. P

✗ 4. N

Q.18 Which figure should replace the question mark (?) if the series were to be continued?

S	T	T	O	A	U	U	Z					
D	O	U	R	S	D	T	Z	O	R	A	T	?
R	A	A	U	R	D	D	O					

Ans

✗ 1.

D	O	
T	B	R
U	Z	

✗ 2.

D	U	
T	R	A
O	Z	

✓ 3.

D	O	
U	B	Z
R	T	

✗ 4.

D	T	
U	B	O
R	Z	

Q.19 A paper is folded and cut as shown below. How will it appear when unfolded?

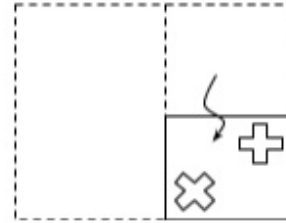
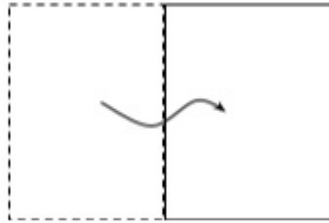

Ans

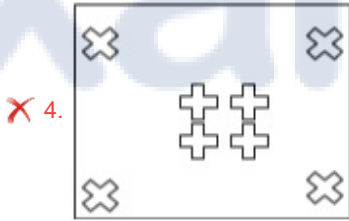
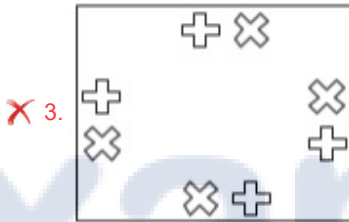
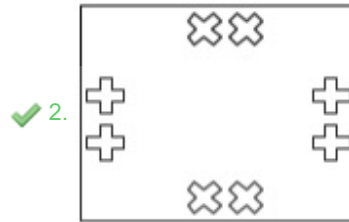
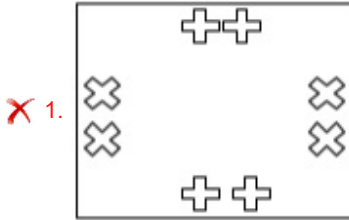

Q.20 Select the correct combination of mathematical signs to sequentially replace the * signs and to balance the given equation.
 $87 * 2 * 80 * 4 * 150 * 4$

- Ans
- ✗ 1. $\times - + + =$
 - ✗ 2. $\div \times - = +$
 - ✗ 3. $\times - = + +$
 - ✓ 4. $\times - \div = +$

Q.21 How many triangles are there in the given figure?

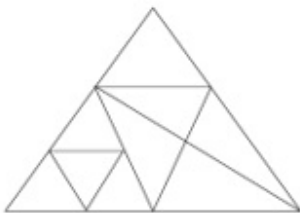

- Ans
- ✗ 1. 12
 - ✓ 2. 17
 - ✗ 3. 14
 - ✗ 4. 15

Q.22 Six students are sitting around a circular table facing the centre. Dwiti is an immediate neighbour of both Durga & Dheeraj. Dilip is sitting second to the right of Dwiti. Dev is sitting third to the left of Dheeraj. Dilip is an immediate of both Daksh and Dheeraj. Who is an immediate neighbour of both Daksh and Durga?

- Ans
- ✓ 1. Dev
 - ✗ 2. Dwiti
 - ✗ 3. Dilip
 - ✗ 4. Dheeraj

Q.23 Select the correct mirror image of the given figure when the mirror is placed at MN as shown below.

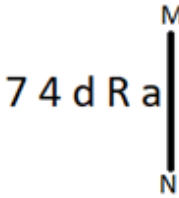

- Ans
- ✓ 1. ɹ ʌ q R ɹ
 - ✗ 2. 7 4 q R ɹ
 - ✗ 3. R a b ɹ ɿ
 - ✗ 4. ʌ q ɹ ɿ 7

Q.24 A paper is folded and cut as shown below. How will it appear when unfolded?

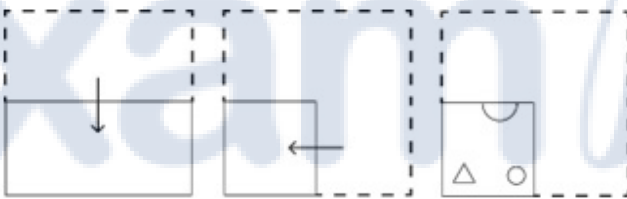

- Ans
- ✗ 1.
 - ✗ 2.
 - ✓ 3.
 - ✗ 4.

Q.25 Select the option that is related to the third term in the same way as the second term is related to the first term as term is related to the fifth term.
225 : 15 :: 1225 : ? :: 2025 : 45

- Ans
- 1. 20
 - 2. 35
 - 3. 30
 - 4. 25

Section : Numerical Ability

Q.1 The difference between the simple interests on ₹1,800 for 3 years at different rates is ₹40. The difference between the rates of interest is:

- Ans
- 1. $\frac{20}{27}\%$
 - 2. $\frac{23}{27}\%$
 - 3. $\frac{13}{27}\%$
 - 4. $\frac{11}{27}\%$

Q.2 How many digits will be there after the decimal point in the product of 0.325 and 1.0302?

- Ans
- 1. 8
 - 2. 7
 - 3. 5
 - 4. 6

Q.3 A sum of money was borrowed and paid back in two annual installments of ₹960 each, allowing 5% compound interest. The sum borrowed was:

- Ans
- 1. ₹1,875.03
 - 2. ₹1,785.03
 - 3. ₹1,695.05
 - 4. ₹1,850.05

Q.4 The side of a triangle is 17 cm and height of the triangle from this side is 10 cm. Find the area of the triangle.

- Ans
- 1. 75 cm^2
 - 2. 95 cm^2
 - 3. 85 cm^2
 - 4. 90 cm^2

Q.5 If the diameter of a hemisphere is 8 cm, then the volume of the hemisphere (in cm^3) is:

- Ans
- 1. $48\frac{1}{3}\pi$
 - 2. $41\frac{2}{3}\pi$
 - 3. $46\frac{1}{3}\pi$
 - 4. $42\frac{2}{3}\pi$

Q.6 A student goes to school at a speed of 20 km/h and reaches 6 min late. If he goes at a speed of 30 km/h, he is 6 min early. What is the distance to the school?

- Ans
- 1. 17 km
 - 2. 18 km
 - 3. 16 km
 - 4. 12 km

Q.7 Ram sold a chair at a profit of $7\frac{1}{2}\%$. If he had sold it for ₹1,430 more, he would have gained 35%. What is the cost price of the chair?

- Ans
- 1. ₹4,800
 - 2. ₹5,000
 - 3. ₹5,200
 - 4. ₹4,000

Q.8 The HCF of $\frac{1}{3}, \frac{2}{3}, \frac{2}{9}$ and $\frac{3}{12}$ is:

- Ans
- 1. $\frac{1}{12}$
 - 2. $\frac{1}{60}$
 - 3. $\frac{1}{48}$
 - 4. $\frac{1}{36}$

Q.9 Farida shifted to a job in the social sector at a monthly salary that was 28% less than the monthly salary she was getting in her previous job. If Farida's monthly salary in the job in the social sector is ₹27,000, what was her monthly salary (in ₹) in the previous job?

- Ans
- 1. 37500
 - 2. 36000
 - 3. 38250
 - 4. 38500

Q.10 A works twice as fast as B. If both of them together can finish a piece of work in 12 days, then B alone can do it in:

- Ans
- 1. 36 days
 - 2. 38 days
 - 3. 34 days
 - 4. 32 days

Q.11 If the average of 5 consecutive numbers is 24, then the smallest number is:

- Ans
- 1. 22
 - 2. 20
 - 3. 23
 - 4. 21

Q.12 There are only two hostels in XYZ University, Hostel P and Hostel Q, wherein an equal number of students were living in both hostels in year 2021. The total number of persons living in both hostels of XYZ University fell by 33% to 8,375 in 2022 from 2021. How many students were living in Hostel P in 2021?

- Ans**
- 1. 5,612
 - 2. 5,750
 - 3. 12,500
 - 4. 6,250

Q.13 What is the LCM of 9, 8.1, 0.27, 0.09?

- Ans**
- 1. 801
 - 2. 81
 - 3. 8100
 - 4. 810

Q.14 The ratio of incomes of A, B and C is 3 : 5 : 4. If the income of A is tripled, the income of C is doubled and the income of B remains the same, what is the ratio of their new incomes?

- Ans**
- 1. 5 : 8 : 9
 - 2. 9 : 5 : 8
 - 3. 8 : 5 : 9
 - 4. 9 : 8 : 5

Q.15 After allowing a discount of 20% on the marked price of an article, it is sold for ₹500. Find its marked price.

- Ans**
- 1. ₹550
 - 2. ₹520
 - 3. ₹625
 - 4. ₹525

Section : Computer Proficiency

Q.1 In MS Excel 365, Which of the following keyboard shortcuts is used to auto fit row height manually in MS Excel?

- Ans**
- 1. Alt + O + C + N
 - 2. Alt + H + O + H
 - 3. Alt + H + O + A
 - 4. Alt + O + C + W

Q.2 In MS-Word 365, which text alignment option is commonly used for legal documents, as it aligns the text along both the left and right margins, leaving a jagged edge on the right side?

- Ans**
- 1. Right Align
 - 2. Center Align
 - 3. Justify
 - 4. Left Align

Q.3 Which protocol allows users to make real-time voice and video calls over the internet?

- Ans**
- 1. DNS
 - 2. FTP
 - 3. Email
 - 4. VoIP

Q.4 Which of the following shortcut keys is used to make Centre-aligned text in MS-Word 365?

- Ans**
- 1. Ctrl + R
 - 2. Ctrl + C
 - 3. Ctrl + J
 - 4. Ctrl + E

Q.5 When you 'reply' to an email, what does it mean?

- Ans**
- 1. You're sending the email to a different recipient.
 - 2. You're sending the same email back to the original sender.
 - 3. You're deleting the email.
 - 4. You're sending a new email to the same recipient.

Q.6 In MS Word 365 which of the following menus is used to open a word document?

- Ans**
- 1. Power
 - 2. Control panel
 - 3. Start
 - 4. Mozilla

Q.7 In Microsoft Word 365, the AutoCorrect feature is used for _____.

- Ans**
- 1. formulas
 - 2. short repetitive text
 - 3. outside margin text
 - 4. misspelled text

Q.8 Which of the following tabs is used in MS Word 365 if we want to delete a table?

- Ans**
- 1. File tab
 - 2. Layout tab
 - 3. Edit tab
 - 4. Insert tab

Q.9 In MS Excel 365, which of the following is the correct shortcut key to open an existing spreadsheet in MS Excel?

- Ans**
- 1. Press Alternate (Alt) + O
 - 2. Press Control (Ctrl) + O
 - 3. Press Control (Ctrl) + N
 - 4. Press Alternate (Alt) + N

Q.10 In MS Excel 365, which of the following groups contains the Insert and Delete command in the Home tab of the ribbon in MS-Excel 365?

- Ans**
- 1. Editing
 - 2. Cells
 - 3. Font
 - 4. Alignment

Constable Executive Male and Female in Delhi Police Examination 2023

Exam Date	01/12/2023
Exam Time	9:00 AM - 10:30 AM
Subject	Constable Executive Male and Female in Delhi Police Examination 2023

Section : General Knowledge

Q.1 Which of the following are also known as a stratovolcanoes, a large volcano generally composed of lava flows, pyroclastic deposits, and mudflow deposits, as well as lava domes?

- Ans**
- 1. Shield volcanoes
 - 2. Mid-ocean ridge volcanoes
 - 3. Composite volcanoes
 - 4. Cinder cone volcanoes

Q.2 Which of the following statements is INCORRECT?

- Ans**
- 1. NNP at factor cost is referred to as the national income.
 - 2. Personal Income and Personal Disposable Incomes are concepts related to households' income.
 - 3. GNP includes output produced by a nation's owned factors of production
 - 4. From the point of view of employment generation at home, GNP is more relevant than GDP.

Q.3 According to the Census of India 2011, which state of India has the highest Buddhist population?

- Ans**
- 1. Assam
 - 2. Maharashtra
 - 3. Madhya Pradesh
 - 4. Sikkim

Q.4 Which Article of the Constitution of India says that the State shall endeavour to secure for the citizens a uniform civil code throughout the territory of India?

- Ans**
- 1. Article 51
 - 2. Article 44
 - 3. Article 42
 - 4. Article 40

Q.5 Which of the following committees was constituted in 2012 to review the Poverty Measurement Methodology and submitted its report in June 2014?

- Ans**
- 1. Dandekar Committee
 - 2. Kirit Parikh Committee
 - 3. Rangarajan Committee
 - 4. Lakdawala Committee

Q.6 When does the Raksha Bandhan fall according to the Hindu calendar?

- Ans**
- 1. Bhadrapada Poonima (Shukla)
 - 2. Kartika Poonima (Shukla)
 - 3. Shravana Poonima (Shukla)
 - 4. Phalguna Poonima (Shukla)

Q.7 Identify the correct statement in the context of National Income Accounting.
 (i) Depreciation is unexpected obsolescence.
 (ii) Capital loss is unexpected obsolescence.
 (iii) Intermediate goods get completely used up or are resold during a given year.

- Ans**
- 1. Only (iii)
 - 2. Only (ii)
 - 3. Both (i) and (iii)
 - 4. Only (i)

Q.8 'My Days' is an autobiography written by whom among the following authors?

- Ans**
- 1. Shashi Kapoor
 - 2. RK Narayan
 - 3. Hema Malini
 - 4. Vajayantimala

Q.9 Which of the following Writs protects the right to life and personal liberty?

- Ans**
- 1. Prohibition
 - 2. Mandamus
 - 3. Habeas Corpus
 - 4. Quo Warranto

Q.10 Akbar's half-brother Mirza Hakim was the ruler of _____ and revolted against Akbar.

- Ans**
- 1. Lahore
 - 2. Kabul
 - 3. Iran
 - 4. Ferghana

Q.11 From which of the following states does singer Shyamamani Devi hail?

- Ans**
- 1. Uttar Pradesh
 - 2. Madhya Pradesh
 - 3. Tripura
 - 4. Odisha

Q.12 Siri Fort at New Delhi of medieval times is an epitome of which of the following architectures?

- Ans**
- 1. Mauryan architecture
 - 2. Kalinga architecture
 - 3. Dravidian architecture
 - 4. Islamic Architecture

Q.13 Which of the following institutions govern and control the cricket matches?

- Ans**
- 1. FIDE
 - 2. FIH
 - 3. FIFA
 - 4. ICC

Q.14 According to Census of India 2011, what was the population density of India?

- Ans**
- 1. 384 person/km²
 - 2. 386 person/km²
 - 3. 388 person/km²
 - 4. 382 person/km²

Q.15 Which of the following Articles of the Constitution of India talks about equality before law or equal protection of t
Ans 1. Article 17
 2. Article 23
 3. Article 14
 4. Article 21

Q.16 In cricket, the field is oval with a rectangular area in the middle, known as 'pitch', which is _____ wide.
Ans 1. 11 yards (10.97 m) by 9 feet (2.26 m)
 2. 22 yards (20.12 m) by 10 feet (3.04 m)
 3. 13 yards (13.52 m) by 7 feet (1.84 m)
 4. 15 yards (15.11 m) by 8 feet (2.04 m)

Q.17 Which of the following statements is/are correct regarding the Directive Principles of State Policy of the Indian Constitution?
A. The 42nd Constitutional Amendment Act of 1976 added six Directive Principles of State Policy to the Constitution.
B. The 86th Constitutional Amendment Act of 2002 substituted a new article for Article 45 and made elementary education as a Fundamental Right.
Ans 1. Both A and B
 2. A only
 3. Neither A nor B
 4. B only

Q.18 Where was Mahatma Gandhi's first major public appearance in India after his return from South Africa?
Ans 1. At the Indigo Satyagraha at Champaran, in 1917
 2. At the mill workers' protest at Kheda, in 1917
 3. At the protest against the King's visit at Bombay, in 1916
 4. At the opening ceremony of the Banaras Hindu University, Banaras, in 1916

Q.19 उच्चतम न्यायालय या उच्च न्यायालय के न्यायाधीश को किस आधार पर पद से हटाया जा सकता है?
Ans 1. केवल सिद्ध कदाचार
 2. असमर्थता और राजनीतिक संबंध
 3. केवल असमर्थता
 4. सिद्ध कदाचार और असमर्थता

Q.20 Which is India's biggest football stadium?
Ans 1. Jawaharlal Nehru Stadium
 2. Salt Lake City Stadium
 3. Chandrasekharan Nair Stadium
 4. Indira Gandhi Stadium

Q.21 Which type of jurisdiction of the Supreme Court can be invoked for the given category of case if the High Court on appeal reverses an order of acquittal of an accused person and sentences him to death?
Ans 1. Review of judgments or orders by the Supreme Court (Art. 137)
 2. Appellate jurisdiction in regard to civil matters (Art. 133)
 3. Appellate jurisdiction in regard to criminal matters (Art. 134)
 4. Appellate jurisdiction in appeals from High Courts in certain cases (Art. 132)

Q.22 The National Waterways-4 (NW-4) is associated with which rivers from among the following?
Ans 1. Narmada and Tapi
 2. Godavari and Krishna
 3. Chambal and Mahanadi
 4. Ganga and Yamuna

Q.23 The part of the Peninsular plateau lying north of the Narmada river is known as:

- Ans
- 1. Western Ghats
 - 2. Deccan Plateau
 - 3. Central Highlands
 - 4. Eastern Ghats

Q.24 Kalamandalam Gopi was awarded the Padma Shri for which form of dance?

- Ans
- 1. Kuchipudi
 - 2. Kathakali
 - 3. Kathak
 - 4. Bharatanatyam

Q.25 Which of the following is absent in prokaryotic cells?

- Ans
- 1. Ribosomes
 - 2. Nuclear membrane
 - 3. Cell wall
 - 4. Cytoplasm

Q.26 Who was the Sultan of the Delhi Sultanate when the Bahmani Kingdom was established in South India?

- Ans
- 1. Alauddin Khalji
 - 2. Muhammad-bin-Tughlaq
 - 3. Ibrahim Lodi
 - 4. Shamsud-Din Iltutmish

Q.27 Where did Mangal Pandey refuse to use the greased cartridge?

- Ans
- 1. Meerut
 - 2. Kanpur
 - 3. Barrackpore
 - 4. Delhi

Q.28 Name the dance of Rajasthan which uses a fake horse ride as a prop.

- Ans
- 1. Pavri Naach
 - 2. Ghode Modni
 - 3. Dindi and Kala
 - 4. Kacchi Ghodi

Q.29 Which of the following are used as soil binders?

- Ans
- 1. Algae
 - 2. Pteridophytes
 - 3. Fungi
 - 4. Bryophytes

Q.30 Pulakeshin II who defeated Harshavardhana belonged to _____ dynasty.

- Ans
- 1. Chola
 - 2. Chera
 - 3. Chalukya
 - 4. Pallava

Q.31 Pandit Ravi Shankar is known to be a legend in Hindustani classical music. He is associated with which of the following instruments?

- Ans**
- 1. Violin
 - 2. Rudra veena
 - 3. Guitar
 - 4. Sitar

Q.32 Impeachment charges against the President can be initiated by either House of the Parliament, but the charges must be signed by _____ members of the impeachment house.

- Ans**
- 1. one-sixth
 - 2. one-third
 - 3. one-tenth
 - 4. one-fourth

Q.33 It has been proved that, during a chemical reaction, atoms are neither created nor destroyed. This law is also known as the:

- Ans**
- 1. law of conservation of charge
 - 2. law of conservation of momentum
 - 3. law of conservation of energy
 - 4. law of conservation of mass

Q.34 New economic policy is also known as _____.

- Ans**
- 1. new economic reforms
 - 2. globalisation
 - 3. new economic law
 - 4. new economic region

Q.35 Which of the following schemes is for collateral free loans to small/micro business enterprises and individuals in the non-agricultural sector?

- Ans**
- 1. PMRPY
 - 2. PMJDY
 - 3. PMEGP
 - 4. PMMY

Q.36 In India, who is regarded as the father of modern dance?

- Ans**
- 1. Vempati Chinna Satyam
 - 2. Kelucharan Mahapatra
 - 3. Uday Shankar
 - 4. Bipin Singh

Q.37 Which of the following rivers is NOT the part of Sapta-Sindhu, the region where early Vedic Aryans lived?

- Ans**
- 1. Bhagirathi
 - 2. Parushni
 - 3. Vitasta
 - 4. Asikni

Q.38 Which is the oldest living tree species with fan-shaped leaves commonly used in the treatment of blood disorders and memory issues?

- Ans**
- 1. Alder
 - 2. Cedar
 - 3. Willow
 - 4. Ginkgo

Q.39 Which of the following is NOT a characteristic of the 4th plan of India?

- Ans**
- 1. It had twin objectives of "growth with stability" and "progressive achievement of self-reliance".
 - 2. Implementation of Family Planning Programmes was among the major targets of the Plan.
 - 3. The influx of Bangladeshi refugees before and after the 1971 Indo-Pak war was an important issue.
 - 4. The plan is considered a big success.

Q.40 What does 'Toran' in the Stupa Architecture refers to?

- Ans**
- 1. Entry gates
 - 2. Umbrella
 - 3. Pillars
 - 4. Dome

Q.41 Who among the following artists received the Padma Shri award in 2021 for his contribution to keep alive the tribal folk dance 'Gussadi'?

- Ans**
- 1. Padmaja Reddy
 - 2. Gopal Prasad
 - 3. R Muthukannammal
 - 4. Kanaka Raju

Q.42 Magma is defined as:

- Ans**
- 1. the extremely hot water springs of the Atlantic region
 - 2. the extremely hot liquid and semi-liquid rock located under the Earth's surface
 - 3. the volatile gaseous environment under the Earth's surface
 - 4. the extremely hot solid core of the Earth

Q.43 Who led the famous Satyagraha of Bardoli?

- Ans**
- 1. Mahatma Gandhi
 - 2. Rajendra Prasad
 - 3. Vithalbhai Patel
 - 4. Sardar Vallabhbhai Patel

Q.44 The Planning Commission looks after crucial aspects such as formulation, implementation and regulation of the Five-Year Plans. In which year was the Planning Commission replaced by a think tank called NITI Aayog?

- Ans**
- 1. 2015
 - 2. 2020
 - 3. 2012
 - 4. 2017

Q.45 Who among the following was the recruiter, caretaker and commander of the Rani of Jhansi Regiment?

- Ans**
- 1. Usha Mehta
 - 2. Bhikaiji Cama
 - 3. Sucheta Kriplani
 - 4. Lakshmi Swaminathan

Q.46 Which of the following statements are correct regarding the Pushkar Fair of Rajasthan?

- A. The main aim of the Pushkar Fair is to promote show cattle such as camels, horses, cows, goats, sheep etc.
- B. This festival is celebrated in the month of November at the time of Kartik Purnima.
- C. Although this festival is an animal festival, the trade of animals is prohibited in the fair.

- Ans**
- 1. B and C only
 - 2. A and C only
 - 3. A,B and C
 - 4. A and B only

Q.47 Where is the headquarters of the Squash Rackets Federation of India located?

- Ans
- 1. Chennai
 - 2. Mumbai
 - 3. New Delhi
 - 4. Bangalore

Q.48 Which of the following groups of crops is related to the Kharif season in the northern states of India?

- Ans
- 1. Jute, Wheat, Pea
 - 2. Wheat, Gram, Rapeseed
 - 3. Barley, Gram, Mustard
 - 4. Rice, Maize, Bajra

Q.49 'The Race of My Life' is written by which of the following personalities?

- Ans
- 1. PT Usha
 - 2. Milkha Singh
 - 3. Dutee Chand
 - 4. Praveen Kumar

Q.50 Which of the following is NOT one of the tax slabs under GST?

- Ans
- 1. 5%
 - 2. 12%
 - 3. 30%
 - 4. 28%

Section : Reasoning

Q.1 Select the correct combination of mathematical signs to sequentially replace the * signs and to balance the given equation.
 $263 * 225 * 5 * 76 * 98 * 3$

- Ans
- 1. = ÷ - + ×
 - 2. ÷ - - + × =
 - 3. = - - + × ÷
 - 4. = - ÷ + ×

Prepare 50% Faster

Q.2 Select the option figure that will replace the question mark (?) in the figure given below to complete the pattern.

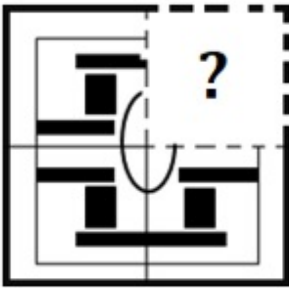

Ans

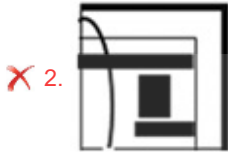
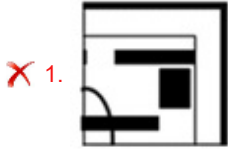

Q.3 Select the option in which the given figure is embedded (rotation is NOT allowed).



Ans

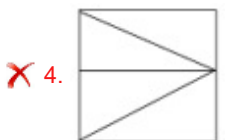
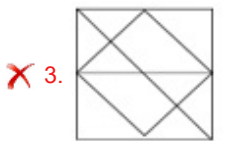
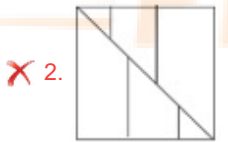

Q.4 P, Q, R, S, T, U and V were sitting in a straight row, facing north. T was to the immediate left of U. V was second to the left of P. Only R was to the right of U. P was exactly between Q and S. Who among the following was at the third position from the left?

- Ans
- ✓ 1. P
 - ✗ 2. Q
 - ✗ 3. S
 - ✗ 4. T

Q.5 Select the option in which the given figure is embedded (rotation is NOT allowed).



- Ans
- ✓ 1.
 - ✗ 2.
 - ✗ 3.
 - ✗ 4.

Prepare 50% Faster

Q.6 A paper is folded and cut as shown below. How will it appear when unfolded?

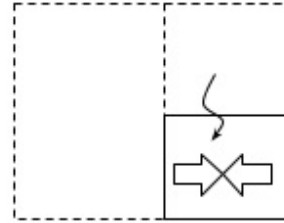
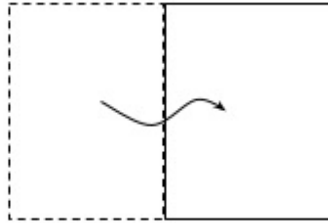

Ans

✗ 1.

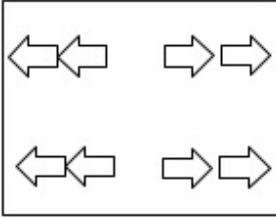

✓ 2.

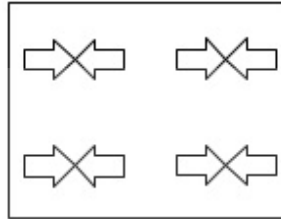

✗ 3.

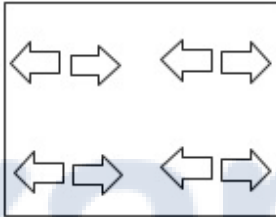

✗ 4.

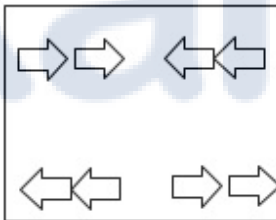

Q.7 Which figure should replace the question mark (?) if the series were to be continued?

LOVER	OVERA	EOVAR	OVART	?
-------	-------	-------	-------	---

Ans

1. TOVAR

2. VAOTR

3. AOVTR

4. VOTAR

Q.8 Select the correct combination of mathematical signs to sequentially replace the * signs and to balance the given equation.
 $999 * 111 * 67 * 87 * 2 * 116$

Ans 1. $++-x=$

2. $\div--+x=$

3. $++-x=$

4. $\div-x+=$

Q.9 Select the word-pair that best represents a similar relationship to the one expressed in the pair of words given below.
 (The words must be considered as meaningful English words and must not be related to each other based on the number of letters/number of consonants/vowels in the word.)
 Water : Hydrology

Ans 1. Monuments : Archaeologist

2. Chemistry : Chemist

3. Space : Astronomy

4. Book : Reading

Q.10 Select the option that is related to the third term in the same way as the second term is related to the first term and the sixth term is related to the fifth term.
 $2 : 9 :: 8 : ? :: 4 : 65$

Ans 1. 344

2. 511

3. 65

4. 513

Q.11 Select the option figure which is embedded in the given figure (Rotation is NOT allowed).

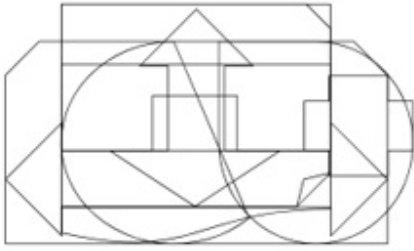

Ans

X 1.



X 2.



X 3.



✓ 4.



Q.12 Select the option in which the given figure is embedded (rotation is NOT allowed).



Ans

✗ 1.



✗ 2.



✗ 3.



✓ 4.

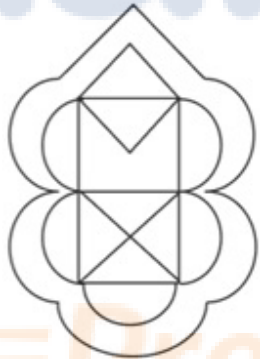

Q.16 Read the given statements and conclusions carefully. Assuming that the information given in the statements is true and it appears to be at variance with commonly known facts, decide which of the given conclusions logically follow(s) from the statements.

Statements:

All mangoes are grapes.

All grapes are guava.

Conclusions:

I. Some guavas are grapes.

II. Some grapes are mangoes.

- Ans
- 1. Only conclusion I follows
 - 2. Neither conclusion I nor II follows
 - 3. Only conclusion II follows
 - 4. Both conclusions I and II follow

Q.17 Select the option which when placed in the blank space of the given figure will complete the pattern.

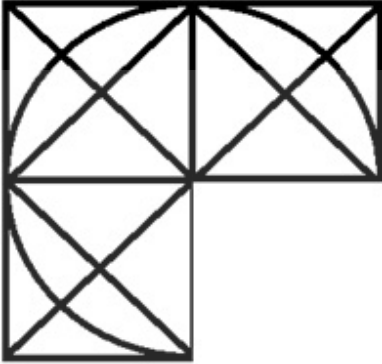

Ans

1.



2.



3.



4.



Q.18 Which figure should replace the question mark (?) if the following series were to be continued?

H	3	□	C	□	D	6	0	A	X	A	□	H	3	C	?
C	0	D	H	3	0	X	3	□	6	0	3	D	0	A	
X	6	A	A	X	6	D	H	C	C	D	H	□	6	X	

Ans

✗ 1.

□	C	A
H	3	0
D	X	6

✓ 2.

D	C	A
H	3	0
X	□	6

✗ 3.

□	6	X
H	3	C
D	0	A

✗ 4.

D	0	3
H	A	C
X	□	6

Q.19 Select the number from among the given options that can replace the question mark (?) in the following series.

10, 24, 66, 192, 570, ?

Ans ✓ 1. 1704

✗ 2. 1699

✗ 3. 1500

✗ 4. 2353

Prepare 50% Faster

Q.20 Select the figure from among the given options that can replace the question mark (?) in the following series.

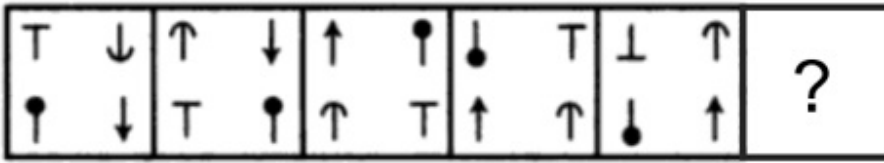

Ans

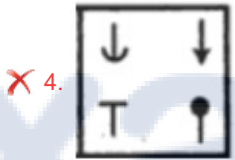
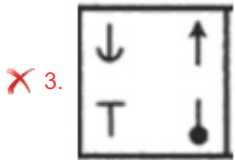
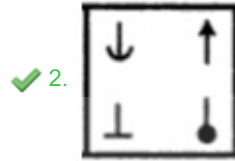
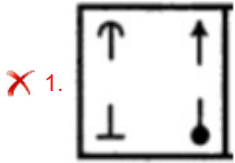

Q.21 Select the correct mirror image of the given figure when the mirror is placed at PQ as shown below.



Q.22 How many triangles are there in the given figure?

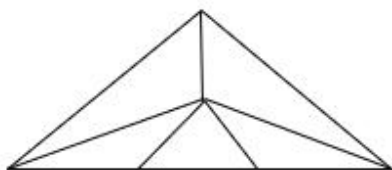

Ans ✗ 1. 8

✓ 2. 9

3. 10

4. 6

Q.23 Which of the following terms will replace the question mark (?) in the given series?

BMRG, FKUF, ?, NGAD, REDC

- Ans
- 1. IMYD
 - 2. IJXE
 - 3. JIXE
 - 4. JHYD

Q.24 Study the given pattern carefully and select the number that can replace the question mark (?) in it.

First row - 3, 16, 13

Second row - 25, 625, 650

Third row - 11, 64, ?

(NOTE : Operations should be performed on the whole numbers, without breaking down the numbers into its constituent digits. Eg. 13 – Operations on 13 such as adding /subtracting/multiplying etc. to 13 can be performed. Breaking down 13 into 1 and 3 and then performing mathematical operations on 1 and 3 is not allowed)

- Ans
- 1. 138
 - 2. 167
 - 3. 169
 - 4. 129

Q.25 Select the correct mirror image of the given figure when the mirror is placed at 'AB' as shown.

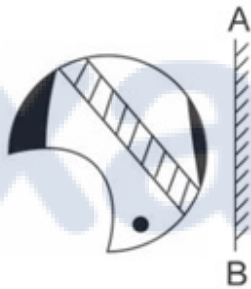

Ans

- 1.
- 2.
- 3.
- 4.

Q.1 The price of sugar goes up by 25%. By how much percentage must a family reduce their consumption of sugar so that their expenditure on sugar remains the same?

- Ans
- 1. 20%
 - 2. 25%
 - 3. 26%
 - 4. 23%

Q.2 The greatest number that exactly divides 126, 198 and 162 is:

- Ans
- 1. 27
 - 2. 18
 - 3. 81
 - 4. 9

Q.3 The HCF of 0.0006, 0.006, 0.06, 0.6 and 6 is:

- Ans
- 1. 0.0006
 - 2. 0.6
 - 3. 0.06
 - 4. 6

Q.4 The average age of three persons is 54 years and their ages are in the proportion 2 : 3 : 4. Find the age of the youngest person.

- Ans
- 1. 36 years
 - 2. 34 years
 - 3. 28 years
 - 4. 32 years

Q.5 A person promised to pay ₹9,048 to the bank in 5 equal annual instalments at the rate of 8% per annum simple interest. The annual instalment (in ₹) paid is:

- Ans
- 1. 1650
 - 2. 1100
 - 3. 1050
 - 4. 1560

Q.6 The sum of three distinct prime numbers is 44. What is the largest possible prime number?

- Ans
- 1. 43
 - 2. 41
 - 3. 31
 - 4. 37

Q.7 Pihu buys a chocolate for ₹225 and sells it for ₹300. What will be her gain percentage? (Rounded off to two decimal places)

- Ans
- 1. 30.35%
 - 2. 25.58%
 - 3. 33.33%
 - 4. 28.25%

Q.8 In five subjects of equal marks, S gets 45, 78, 36, 65 and 56 in the first semester and 48, 72, 55, 46 and 79 in the second semester. What are his average marks in the first year?

- Ans
- 1. 57
 - 2. 56
 - 3. 58
 - 4. 58.5

Q.9 Asha deposits ₹12,500 in a private bank at the rate of 15%, compounded half-yearly. Find the amount Asha earns (in ₹) in $1\frac{1}{2}$ years (rounded off to two decimal places).

- Ans**
- 1. 15028.71
 - 2. 15258.71
 - 3. 15528.71
 - 4. 13404.76

Q.10 A garrison of 1500 men has provisions for 11 days. How long will the provisions last if the garrison is increased by 1800 men?

- Ans**
- 1. 5 days
 - 2. 3 days
 - 3. 6 days
 - 4. 4 days

Q.11 The radius of the base of a conical tent is 20 feet and the slant height of the cone is 35 feet. Find the area (in square feet) of the canvas that is required for making this tent. Ignore the wastage of canvas.

(Use $\pi = \frac{22}{7}$)

- Ans**
- 1. 2175
 - 2. 2150
 - 3. 2225
 - 4. 2200

Q.12 If a number P is 15% less than another number Q, and Q is 12% more than 156, then what is the value of P?

- Ans**
- 1. 148.51
 - 2. 138.52
 - 3. 168.52
 - 4. 178.52

Q.13 A person got a new chair at 35% discount. Had he got no discount, he would have had to pay ₹224 more. What is the marked price (in ₹) of the chair?

- Ans**
- 1. 640
 - 2. 735
 - 3. 750
 - 4. 600

Q.14 Shanti while driving her car at a speed of 68 km/h, observes that at some moment a moving bus is 40 m ahead of her car. After 10 sec she finds that she is 60 m ahead of the bus. What is the speed of the bus?

- Ans**
- 1. 30 km/h
 - 2. 32 km/h
 - 3. 25 km/h
 - 4. 38 km/h

Q.15 The areas of two similar triangles are 48 cm^2 and 156 cm^2 . If the height of the smaller triangle is 6 cm, then the corresponding height (in cm) of the bigger triangle is:

- Ans
- 1. $\sqrt{119}$
 - 2. $\sqrt{121}$
 - 3. $\sqrt{117}$
 - 4. $\sqrt{118}$

Section : Computer Proficiency

Q.1 Which of the following is an example of internet service provider?

- Ans
- 1. Airtel
 - 2. Google
 - 3. Outlook
 - 4. Mozilla

Q.2 Which of the following statements is FALSE regarding attaching a file in an email?

- Ans
- 1. Multiple files can be attached in an email message.
 - 2. You can remove or change attachments before sending the email.
 - 3. The size of the attachment is unlimited.
 - 4. Attachments can be previewed within the email composition window.

Q.3 In MS word 365, While working with the text the thesaurus tool is used for:

- Ans
- 1. corrects misspelling word
 - 2. correct the format of the text
 - 3. check for synonyms and antonyms
 - 4. finding repeated words in the document

Q.4 Which of the following is the purpose of the "Zoom" icon in Microsoft Word 365?

- Ans
- 1. To change the document's page layout
 - 2. To delete the current page
 - 3. To increase the font size
 - 4. To adjust the visual appearance of our document to suit our reading or editing needs

Q.5 In MS Excel 365, Which of the following charts in MS Excel shows the change of magnitude over a period of time?

- Ans
- 1. Area chart
 - 2. Bar chart
 - 3. Line chart
 - 4. Pie chart

Q.6 Which of the following keyboard shortcut keys is used to copy the selected text in MS-Word 365?

- Ans
- 1. Ctrl + C
 - 2. Ctrl + X
 - 3. Ctrl + V
 - 4. Ctrl + P

Q.7 What feature in Microsoft Word 365 allows you to create a numbered list with different levels of indentation?

- Ans**
- 1. Multi-spaced numbering
 - 2. Multi-indenting numbering
 - 3. Multi-hierarchy numbering
 - 4. Multilevel numbering

Q.8 In MS Excel 365, the VLOOKUP function in Microsoft Excel is primarily used for:

- Ans**
- 1. calculating percentages
 - 2. creating pivot tables
 - 3. finding the total of a range
 - 4. searching for a value in a table and returning a corresponding value

Q.9 In MS Excel 365 how can you add a specific number of days to a date in Excel?

- Ans**
- 1. Using the EDATE function
 - 2. Using the WORKDAY function
 - 3. Using the DATE function
 - 4. Using the DAY function

Q.10 Which of the following options allows you to change page orientation in MS Word 365?

- Ans**
- 1. Page break
 - 2. Page layout
 - 3. Paragraph alignment
 - 4. Margins

Constable Executive Male and Female in Delhi Police Examination 2023

Exam Date	01/12/2023
Exam Time	12:00 PM - 1:30 PM
Subject	Constable Executive Male and Female in Delhi Police Examination 2023

Section : General Knowledge

Q.1 Who among the following was the founder of Al-Hilal newspaper during British India?

- Ans**
- 1. Hasrat Mohani
 - 2. Mohammad Ajmal Khan
 - 3. Syed Hasan Imam
 - 4. Maulana Abul Kalam Azad

Q.2 Which age group of children was considered to find the child sex ratio in Census 2011?

- Ans**
- 1. 2 to 5 years
 - 2. 0 to 6 years
 - 3. 0 to 4 years
 - 4. 2 to 6 years

Q.3 As per Article 170 of the Constitution of India, the Legislative Assembly of each State shall consist of NOT more than _____ and not less than 60 members.

- Ans**
- 1. 500
 - 2. 550
 - 3. 600
 - 4. 400

Q.4 Which of the following refers to 'net indirect taxes'?

- Ans**
- 1. Indirect taxes + subsidies
 - 2. Direct Taxes + subsidies
 - 3. Indirect taxes – subsidies
 - 4. Direct taxes – subsidies

Q.5 Who among the following attended all the three Round Table Conferences held in London?

- Ans**
- 1. Tej Bahadur Sapru
 - 2. Sarojini Naidu
 - 3. Mahatma Gandhi
 - 4. Rajendra Prasad

Q.6 The Gangaur festival of Rajasthan starts and ends on which days as per the Hindu calendar?

- Ans**
- 1. First day of Phalguna (Krishna)-Third day of Phalguna (Shukla)
 - 2. First day of Ashadh (Krishna)-Third day of Ashadh (Shukla)
 - 3. First day of Jyeshtha (Krishna)-Third day of Jyeshtha (Shukla)
 - 4. First day of Chaitra (Krishna)-Third day of Chaitra (Shukla)

Q.7 The process of privatisation covers three sets of measures. Which of the following is NOT one of those?

- Ans
- 1. Operational measures
 - 2. Organisational measures
 - 3. Accounting measures
 - 4. Ownership measures

Q.8 'The Truths We Hold: An American Journey' is an autobiography of which political leader?

- Ans
- 1. Elise Stefanik
 - 2. Alexandria Ocasio-Cortez
 - 3. Drew Zachary
 - 4. Kamala Harris

Q.9 Which country is the host of the 2023 ODI Cricket World Cup event?

- Ans
- 1. Sri Lanka
 - 2. Australia
 - 3. Bangladesh
 - 4. India

Q.10 Which of the following statements about the Mitochondria is INCORRECT?

- Ans
- 1. The body uses energy stored in ATP for making new chemical compounds and for mechanical work.
 - 2. Mitochondria are not capable of making their own proteins.
 - 3. Mitochondria have two membrane coverings.
 - 4. ATP generating chemical reactions get enhanced by the deeply folded surface area of the mitochondria.

Q.11 _____ empowers the President to remove inconsistencies between laws passed by the Parliament and State Legislatures and the subjects included in the concurrent list.

- Ans
- 1. Article 259
 - 2. Article 254
 - 3. Article 253
 - 4. Article 250

Q.12 The early Delhi Sultans, were preferring to appoint (in administration) their special slaves purchased for military service, called bandagan in _____ language.

- Ans
- 1. Arabic
 - 2. Urdu
 - 3. Sanskrit
 - 4. Persian

Q.13 Which river in the Himalayas flows parallel to the Ganga as a right-bank tributary?

- Ans
- 1. Kosi
 - 2. Yamuna
 - 3. Ghaghara
 - 4. Gandak

Q.14 What is the common name of the class of red algae?

- Ans
- 1. Phaeophyceae
 - 2. Chlorophyceae
 - 3. Rhodophyceae
 - 4. Xanthophyceae

Q.15 Which of the following is the characteristic of the Indian Constitution?

- Ans
- 1. Presidential form of Government
 - 2. Rigid as well as flexible
 - 3. Smallest constitution
 - 4. Multiple citizenship

Q.16 'A Shot at History: My Obsessive Journey to Olympic Gold', is the autobiography of which of the following Olympian?

- Ans
- 1. Avani Lekhara
 - 2. Major Dhyan Chand
 - 3. Neeraj Chopra
 - 4. Abhinav Bindra

Q.17 Articles 36-51 of the Constitution of India pertain to _____.

- Ans
- 1. Fundamental Duties
 - 2. Directive Principles of State Policy
 - 3. The Union
 - 4. Fundamental Rights

Q.18 Which of the following elements is NOT related to the Trade and Investment Policy Reforms?

- Ans
- 1. Dismantling of quantitative restrictions on imports and exports
 - 2. Removal of licensing for imports
 - 3. Increase in export duties
 - 4. Reduction of tariff rates

Q.19 Among the following industries, the promotion of one industry is part of the directive principle of state policy of our Constitution and that industry is _____.

- Ans
- 1. fertiliser industry
 - 2. steel industry
 - 3. automobile industry
 - 4. cottage industry

Q.20 Which of the following Articles of the Indian Constitution mentions that 'Untouchability' is abolished and its practice in any form is forbidden?

- Ans
- 1. Article 19
 - 2. Article 13
 - 3. Article 15
 - 4. Article 17

Q.21 Which festival was initiated by Shivaji, in his reign, to channelise the patriotic spirit of Hindus?

- Ans
- 1. Karva Chauth
 - 2. Durga Pooja
 - 3. Ganesh Chaturthi
 - 4. Ram Navami

Q.22 The Guptas were believed to have sprung from which varna?

- Ans
- 1. Kshatriya
 - 2. Shudra
 - 3. Vaisya
 - 4. Brahman

Q.23 Identify the Sultan of the Delhi Sultanate who constructed a new garrison town named Siri for his soldiers.

- Ans**
- 1. Shamsuddin Iltutmish
 - 2. Bahlul Lodi
 - 3. Alauddin Khalji
 - 4. Muhammad Tughluq

Q.24 The Manipuri dance of north-eastern India is grown out of the ritual worship of Lord _____ .

- Ans**
- 1. Krishna
 - 2. Vishnu
 - 3. Rama
 - 4. Ganesha

Q.25 As per census 2011, which of the following states recorded the lowest female literacy rate?

- Ans**
- 1. Bihar
 - 2. Haryana
 - 3. Kerala
 - 4. Rajasthan

Q.26 Which is the highest court of appeal in India?

- Ans**
- 1. Lok Adalat
 - 2. Supreme Court of India
 - 3. High Court
 - 4. District Court

Q.27 How many crop varieties with special traits like climate resilience and high nutrient content were launched in 2021 in India?

- Ans**
- 1. 40
 - 2. 35
 - 3. 45
 - 4. 25

Q.28 What is the distance from the lower edge of the crossbar of a football goal to the ground?

- Ans**
- 1. 11 feet
 - 2. 9 feet
 - 3. 10 feet
 - 4. 8 feet

Q.29 Which of the following languages is NOT in the top 3 most spoken native languages of India (as of 2021)?

- Ans**
- 1. Telugu
 - 2. Hindi
 - 3. Bengali
 - 4. Marathi

Q.30 In which year did plague strike Bombay?

- Ans**
- 1. 1896
 - 2. 1894
 - 3. 1893
 - 4. 1892

Q.31 Identify the 'last-living' Sadir dancer who received the Padma Shri in 2022.

- Ans
- 1. R Muthukannammal
 - 2. B Saraswathi
 - 3. S Mahananda
 - 4. K Sashimoni

Q.32 In Karate, which word is used to denote 'Punch'?

- Ans
- 1. Tsuki
 - 2. Seiri
 - 3. Waza-ari
 - 4. Ippon

Q.33 Posthumus Padma awardee in 2022, Gosaveedu Shalik Hassan was a renowned player of the _____.

- Ans
- 1. Veena
 - 2. Sitar
 - 3. Nadaswaram
 - 4. Guitar

Q.34 What was the maximum limit of Statutory Liquidity Ratio (SLR) that was recommended by the Narasimhan Committee?

- Ans
- 1. 15%
 - 2. 35%
 - 3. 25%
 - 4. 22%

Q.35 Which of the following is NOT a component of the Green Revolution?

- Ans
- 1. Fertilisers
 - 2. HYV Seeds
 - 3. Mining
 - 4. Pesticides

Q.36 In medieval architecture, Sarais are places used for _____.

- Ans
- 1. warfare practice
 - 2. hospitals
 - 3. temporary accommodation
 - 4. warehouses

Q.37 The author of Prayag Prashasti, Harisena, was the court poet of whom among the following Gupta rulers?

- Ans
- 1. Kumaragupta
 - 2. Purugupta
 - 3. Sri Gupta
 - 4. Samudragupta

Q.38 Which Indian music composer received his second Grammy in the 'Best New Age Album' category for his 14th studio album 'Divine Tides', which he shared with American musician and composer Stewart Copeland at the 2022 Grammy Awards?

- Ans
- 1. Ricky Kej
 - 2. Mithoon
 - 3. Devi Sri Prasad
 - 4. Harris Jayaraj

Q.39 Privatisation implies _____ a government owned enterprise.

- Ans
- 1. strengthening the management of
 - 2. restricting private players from managing
 - 3. restricting private players to take control of
 - 4. shedding of the ownership or management of

Q.40 Which of the following architectural features/structures was NOT a part of the citadel in Mohenjo-Daro?

- Ans
- 1. Great Courtyard
 - 2. Pillared Hall
 - 3. Warehouse
 - 4. Residential Buildings

Q.41 Bhangra dance is commonly performed in which of these states?

- Ans
- 1. Punjab
 - 2. Uttar Pradesh
 - 3. Maharashtra
 - 4. Chhattisgarh

Q.42 According to the Indian Policy Resolution 1956, which of the following industries is a part of schedule A category?

- Ans
- 1. Fertiliser
 - 2. Mining
 - 3. Textile industry
 - 4. Synthetic rubber

Q.43 In 2022, which sports organisation in India implemented equal match fees for both men and women players?

- Ans
- 1. Board of Control for Cricket in India
 - 2. Boxing Federation of India
 - 3. All India Tennis Association
 - 4. All India Football Federation

Q.44 Which of the following fungus is used in fermentation technology?

- Ans
- 1. Molds
 - 2. Smuts
 - 3. Rhizobium
 - 4. Saccharomyces

Q.45 The goal of Saansad Adarsh Gram Yojana was to develop _____ Adarsh Grams by March 2019.

- Ans
- 1. two
 - 2. five
 - 3. four
 - 4. three

Q.46 Which of the following is a low power (30 kW) research reactor fuelled by uranium-233?

- Ans
- 1. KAMINI
 - 2. MAITRI
 - 3. PRANASH
 - 4. SHAURYA

Q.47 Which of the following statements is INCORRECT about the an earthquake?

- Ans
- 1. An earthquake is caused due to release of energy.
 - 2. An earthquake creates waves that spread in one direction.
 - 3. An earthquake is a natural event.
 - 4. An earthquake is shaking of the earth.

Q.48 Sitara Devi was a dancer of the popular North Indian classical dance form _____.

- Ans
- 1. Kathakali
 - 2. Sattriya
 - 3. Kathak
 - 4. Manipuri

Q.49 When the sun, the moon and the earth are in a straight line, the height of the tide will be higher. What are these tides called?

- Ans
- 1. Autumn tides
 - 2. Diurnal tide
 - 3. Spring tides
 - 4. Neap tides

Q.50 Which of the following increased the legal age of marriage for girls from 10 years to 12 years in British India?

- Ans
- 1. Pitt's India Act of 1784
 - 2. Age of Consent Bill, 1891
 - 3. Hindu Widows Remarriage Act of 1856
 - 4. Government of India Act of 1935

Section : Reasoning

Q.1 उस विकल्प का चयन करें, जो तीसरे शब्द से उसी प्रकार संबंधित है, जिस प्रकार दूसरा शब्द, पहले शब्द से संबंधित है। (शब्दों को अर्थपूर्ण हिंदी/अंग्रेजी शब्दों के रूप में माना जाना चाहिए और शब्द में अक्षरों की संख्या/व्यंजनों/स्वरों की संख्या के आधार पर एक दूसरे से संबंधित नहीं होना चाहिए)
आराधनालय : धर्म :: न्यायालय : ?

- Ans
- 1. मंत्री
 - 2. न्यायाधीश
 - 3. वकील
 - 4. कानून

Q.2 Read the given statements and conclusions carefully. Assuming that the information given in the statements is true, even if it appears to be at variance with commonly known facts, decide which of the given conclusions logically follow(s) from the statements.

Statements:

Some reds are blues.

All blues are greens.

Conclusions:

I. Some reds are greens.

II. Some greens are reds.

- Ans
- 1. Neither conclusion I nor II follows
 - 2. Both conclusions I and II follow
 - 3. Only conclusion II follows
 - 4. Only conclusion I follows

Q.3 Select the option that is related to the fourth number in the same way as the first number is related to the second and the fifth number is related to the sixth number.
 $157 : 13 :: ? : 9 :: 241 : 16$

- Ans**
- ✓ 1. 73
 - ✗ 2. 70
 - ✗ 3. 77
 - ✗ 4. 81

Q.4 Select the correct mirror image of the given figure when the mirror is placed at 'AB' as shown.

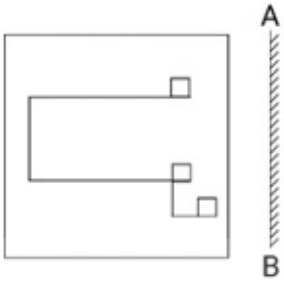

Ans

- ✗ 1.
- ✗ 2.
- ✓ 3.
- ✗ 4.

Q.5 In a code language, if MANGO is coded as 50 and BANANA is coded as 33, then how will COCONUT be coded?

- Ans**
- ✗ 1. 97
 - ✗ 2. 80
 - ✗ 3. 87
 - ✓ 4. 91

Q.6 Which of the following option figures will complete the pattern in the figure given below?



Ans



Q.7 Select the figure from the given options that will replace the question mark (?) in the figure given below to complete the pattern so that the final image is symmetrical.

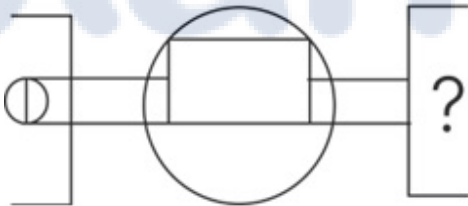

Ans

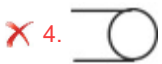
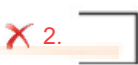

Q.8 Which of the following option figures will complete the pattern in the figure given below?



Ans



Q.9 K, L, M, N, X and Y are sitting around a circular table facing the centre. Only two people sit between M and X. L sits second to the right of X. Y sits to the immediate left of K. How many people sit between N and M when counted from the right of N?

Ans ✓ 1. One

✗ 2. None

✗ 3. Three

✗ 4. Two

Q.10 Select the correct mirror image of the given figure when the mirror is placed at 'MN' as shown below.

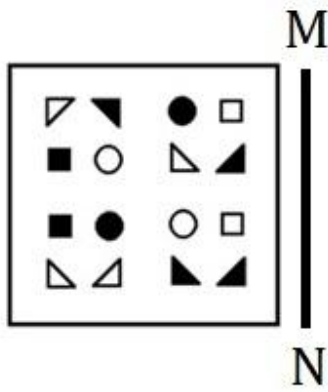

Ans

X 1.

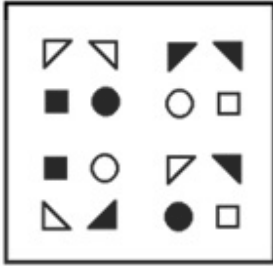

X 2.

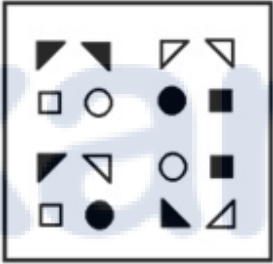

X 3.

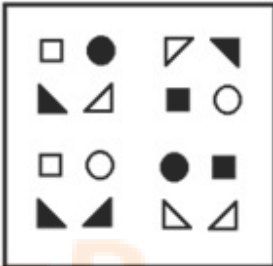

✓ 4.

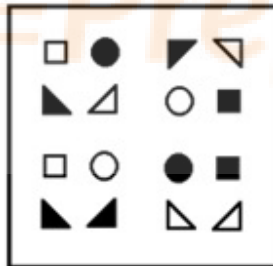

Q.11 Which figure should replace the question mark (?) if the series were to be continued?

3	O	D	3	9	S	L	9	
9	L	S	9	3	D	O	3	?
S	D	△	L	△	O	O	L	△

Ans

✗ 1.

L	D
9	S
O	3

✗ 2.

9	3
L	O
S	D

✓ 3.

3	O
9	L
S	D

✗ 4.

O	L
3	9
△	S

Q.12 A square sheet of paper is folded along the dotted line successively along the directions shown and is then punched last. How would the paper look when unfolded?

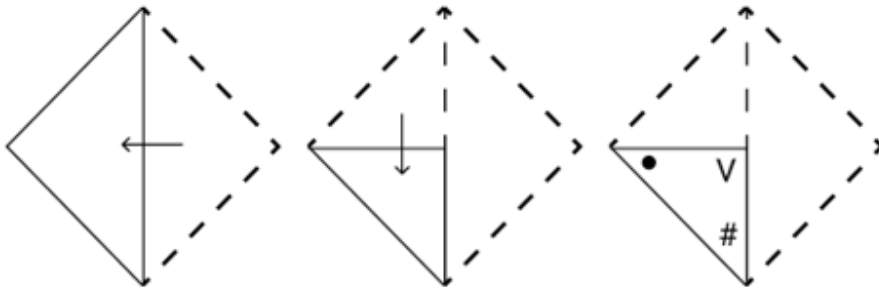

Ans

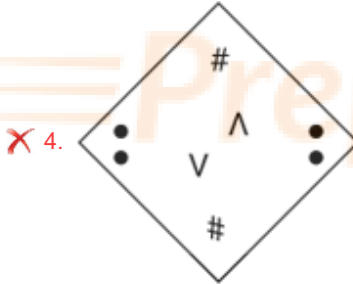
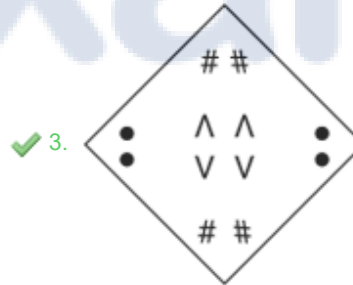
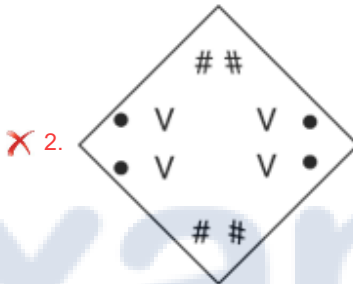
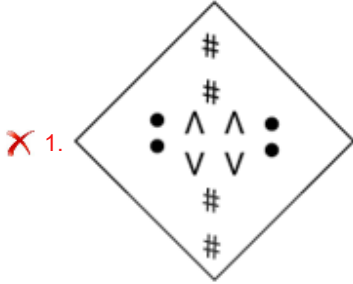

Q.13 Select the option in which the given figure is embedded (rotation is NOT allowed).

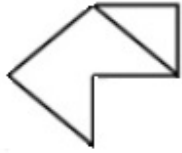

Ans

1.

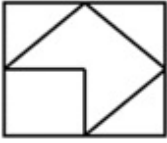

2.

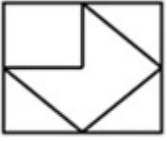

3.



4.

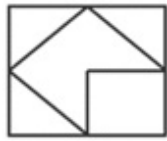

Q.14 Six letters J, K, L, M, N and P are written on different faces of a dice. Two positions of this dice are shown in the figure. Find the letter on the face opposite to 'L'.



Ans 1. P

2. M

3. N

4. K

Q.15 Which figure should replace the question mark (?) if the following series were to be continued?

C O L 3 e	O C e L 3	e O C 3 L	O e L C 3	L O e 3 C	?
-----------	-----------	-----------	-----------	-----------	---

Ans

✓ 1. O L C e 3

✗ 2. e L O C 3

✗ 3. C 3 O e L

✗ 4. C L O e 3

Q.16 Select the correct combination of mathematical signs to sequentially replace the * signs and to balance the given equation.
 $225 * 25 * 3 * 3 * 6 * 6$

Ans ✗ 1. $\div \times + - =$

✗ 2. $\div \times = - +$

✓ 3. $\div = \times - +$

✗ 4. $\div \times - + =$

Q.17 Select the correct combination of mathematical signs to sequentially replace the * signs and to balance the given equation.
 $26 * 52 * 38 * 57 * 23 = 53$

Ans ✗ 1. $-, \times, \div, -$

✗ 2. $+, \times, -, \div$

✗ 3. $\times, \div, +, -$

✓ 4. $\div, \times, +, -$

Q.18 Select the correct mirror image of the given figure when the mirror is placed at PQ as shown below.

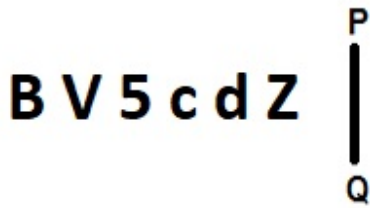

- Ans
- 1. Z P c d Z B V 5 c d Z
 - 2. Z B V 5 c d Z B V 5 c d Z
 - 3. Z B V 5 c d Z B V 5 c d Z
 - 4. Z B V 5 c d Z B V 5 c d Z

Q.19 Select the number from among the given options that can replace the question mark (?) in the following series. 5, 15, 23, 29, ?, 35

- Ans
- 1. 31
 - 2. 30
 - 3. 32
 - 4. 33

Q.20 Six numbers 11, 12, 42, 16, 24 and 33 are written on different faces of a dice. Two positions of this dice are shown in the figure. Find the number on the face opposite to 24.



- Ans
- 1. 12
 - 2. 33
 - 3. 11
 - 4. 16

Prepare 50% Faster

Q.21 Select the figure from among the given options that can replace the question mark (?) in the following series.

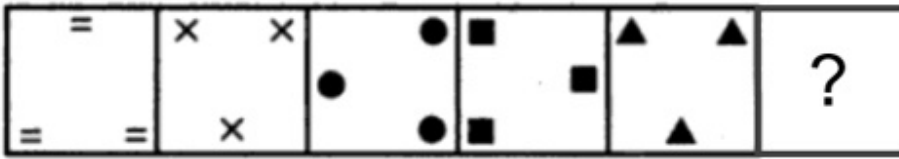

Ans

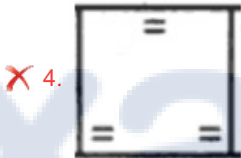
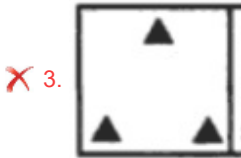
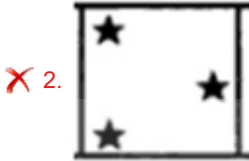
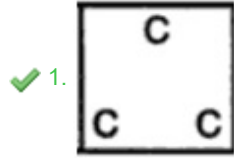

Q.22 Select the correct mirror image of the given figure when the mirror is placed at MN as shown below.

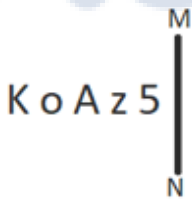

Ans

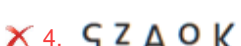
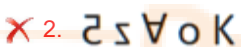
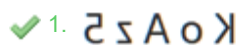

Q.23 How many triangles are there in the given figure?

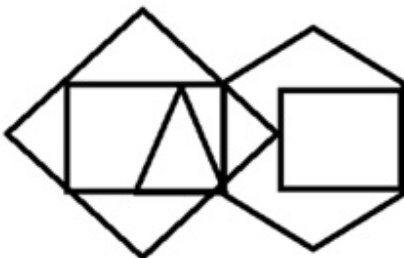

Ans



Q.24 Select the set in which the numbers are related in the same way as are the numbers of the following sets.
 (NOTE: Operations should be performed on the whole numbers, without breaking down the numbers into its constituent digits. E.g. 13 – Operations on 13 such as adding/deleting/multiplying etc. to 13 can be performed. Breaking down 13 into 1 and 3 and then performing mathematical operations on 1 and 3 is not allowed)
 (5, 23, 74)
 (8, 62, 191)

- Ans**
- 1. (4, 14, 46)
 - 2. (7, 47, 146)
 - 3. (10, 98, 289)
 - 4. (3, 11, 38)

Q.25 Which of the following terms will replace the question mark (?) in the given series?
 NHC, PKG, ?, TQO, VTS

- Ans**
- 1. SNK
 - 2. RML
 - 3. RNK
 - 4. SNL

Section : Numerical Ability

Q.1 In a village, there is a pond that has the radius 14 m. There is a fountain of diameter 14 m in the centre of the pond. Calculate the area of the pond excluding the fountain. (Use $\pi = \frac{22}{7}$)

- Ans**
- 1. 412 m²
 - 2. 462 m²
 - 3. 482 m²
 - 4. 452 m²

Q.2 The average weight of A, B and C is 65 kg. The average weight of A and B is 62 kg and that of B and C is 57 kg. The weight of B is:

- Ans**
- 1. 56 kg
 - 2. 53 kg
 - 3. 43 kg
 - 4. 40 kg

Q.3 What is the least common multiple of 44, 108, 135, 162 and 198?

- Ans**
- 1. 820
 - 2. 17820
 - 3. 728
 - 4. 1778

Q.4 A person gives 25% discount and still gains 20%. What percentage above the M.P. is the C.P.?

- Ans**
- 1. 25%
 - 2. 60%
 - 3. 18%
 - 4. 45%

Q.5 400 men have provisions for 23 weeks. They are joined by 60 men. How long will the provisions last?

- Ans**
- 1. 24 weeks
 - 2. 20 weeks
 - 3. 26 weeks
 - 4. 16 weeks

Q.6 The surface area of a sphere of radius 4 cm is eight times the area of the curved surface area of a cone whose radius is 4 cm. Find the volume of the cone.

- Ans**
- 1. $\frac{4\pi}{\sqrt{3}} \text{ cm}^3$
 - 2. $\frac{2\pi}{\sqrt{3}} \text{ cm}^3$
 - 3. $\frac{8\pi}{\sqrt{3}} \text{ cm}^3$
 - 4. $\frac{6\pi}{\sqrt{3}} \text{ cm}^3$

Q.7 A vendor bought buttons at 22 for a rupee. How many must he sell for a rupee to gain 10%?

- Ans**
- 1. 19
 - 2. 16
 - 3. 20
 - 4. 18

Q.8 At what rate per annum on simple interest will a sum of money double itself in 8 years?

- Ans**
- 1. 12.5%
 - 2. 6.25%
 - 3. 2.5%
 - 4. 5.6%

Q.9 A company is earning an income from which expenditure (other than tax) is deducted to get the amount of profit earned. The company has to pay tax of 22% on the profit earned. If net profit after paying taxes is ₹2,340, which is 18% of expenditure (other than taxes), what was the income (in ₹) of the company?

- Ans**
- 1. 19,000
 - 2. 16,667
 - 3. 13,000
 - 4. 16,000

Q.10 The number of prime numbers which are greater than 50 and less than 100 is:

- Ans**
- 1. 10
 - 2. 13
 - 3. 9
 - 4. 11

Q.11 A train increases its usual speed by 16% and reaches its destination 30 minutes early. What is the time taken (in hours) normally by the train in the journey?

- Ans**
- 1. $1\frac{5}{8}$
 - 2. $3\frac{5}{8}$
 - 3. $2\frac{3}{8}$
 - 4. $6\frac{5}{8}$

Q.12 A city's population is 1,00,000. Next year it is expected to increase by 12%, and the year after that it is expected to increase by 10%. Finally, the new population would be:

- Ans**
- 1. 1,01,600
 - 2. 1,08,400
 - 3. 1,05,600
 - 4. 1,00,800

Q.13 Two sums of money are proportional to 5 : 9. If the first sum is 55, then the second sum is:

- Ans**
- 1. 88
 - 2. 85
 - 3. 99
 - 4. 77

Q.14 What is the difference between the compound interests on ₹8,000 for 1 year at 6% per annum compounded yearly and half-yearly?

- Ans**
- 1. ₹7.9
 - 2. ₹7.2
 - 3. ₹5.5
 - 4. ₹6.2

Q.15 What is sum of the product of the 1st & 5th prime numbers and the 3rd & 9th prime numbers?

- Ans**
- 1. 137
 - 2. 118
 - 3. 212
 - 4. 101

Section : Computer Proficiency

Q.1 Which of the following is the advantage of using an Electronic mail?

- Ans**
- 1. It is convenient and fast communication with individuals or groups globally.
 - 2. It can lead to decreased face-to-face communication and loss of personal touch.
 - 3. Vulnerability to spam and phishing threats.
 - 4. An overwhelming number of emails can lead to information overload.

Q.2 What is the purpose of the 'Undo' command in Microsoft Excel?

- Ans**
- 1. It saves the current workbook.
 - 2. It copies selected cells.
 - 3. It reverses the last action performed.
 - 4. It inserts a new worksheet.

Q.3 In MS-Word 365, which feature allows you to create a new document quickly without having to start from scratch, using a predefined layout and formatting?

- Ans**
- 1. Spelling and Grammar Check
 - 2. AutoSave
 - 3. Print Layout View
 - 4. Document Template

Q.4 Which of the following is NOT a type of communication on the internet?

- Ans**
- 1. Video conferencing
 - 2. Telepathy
 - 3. Chat
 - 4. Email

Q.5 How do we move a piece of text from one place to another in Microsoft Word 365?

- Ans**
- 1. Cut and Paste
 - 2. Copy and Paste
 - 3. Copy and Insert
 - 4. Cut and Insert

Q.6 Which of the following Tabs is used to locate Bullets and Numbering icons of MS-Word 2010?

- Ans**
- 1. View Tab
 - 2. Home Tab
 - 3. Insert Tab
 - 4. Design Tab

Q.7 What is the shortcut command in MS-Word 365 for cutting the text?

- Ans**
- 1. Ctrl + Z
 - 2. Ctrl + V
 - 3. Ctrl + X
 - 4. Ctrl + C

Q.8 What is the purpose of the 'Drag-and-Drop' method in Microsoft Word 365?

- Ans**
- 1. To format text
 - 2. To print text
 - 3. To copy or move text by dragging it to a new location
 - 4. To select text

Q.9 In MS Excel 365, to open an existing spreadsheet, which of the following shortcut keys is used?

- Ans**
- 1. Ctrl + O
 - 2. Ctrl + I
 - 3. Ctrl + N
 - 4. Ctrl + E

Q.10 In MS Excel 365, which of the following options in MS Excel will arrange data in descending order based on the selected column(s)?

- Ans**
- 1. Click the filter button
 - 2. Click on 'Find & Select'
 - 3. Click the 'Sort Z to A' button
 - 4. Click 'Sort A to Z'

Constable Executive Male and Female in Delhi Police Examination 2023

Exam Date	03/12/2023
Exam Time	3:00 PM - 4:30 PM
Subject	Constable Executive Male and Female in Delhi Police Examination 2023

Section : General Knowledge

Q.1 The mob-burning of a police station in Chauri Chaura in 1922 brought about the end of the Non-Cooperation Movement. In which present-day state is Chauri Chaura located?

- Ans**
- 1. Haryana
 - 2. Punjab
 - 3. Uttar Pradesh
 - 4. Bihar

Q.2 Which Article of the Constitution of India consists of the provision for the establishment of the Finance Commission?

- Ans**
- 1. Article 280
 - 2. Article 270
 - 3. Article 260
 - 4. Article 250

Q.3 Har Ghar Tiranga campaign was launched for which of the following national day celebrations?

- Ans**
- 1. Independence Day
 - 2. Children's Day
 - 3. Republic Day
 - 4. Gandhi Jayanti

Q.4 Which Governor General built the Victoria Memorial in Kolkata in 1905 in the memory of Queen Victoria of Britain?

- Ans**
- 1. Lord Ripen
 - 2. Lord Bentinck
 - 3. Lord Curzon
 - 4. Lord Canning

Q.5 What is the name for the gestures used in Bharatnatyam?

- Ans**
- 1. Gatakas
 - 2. Laya
 - 3. Tripatakas
 - 4. Mudras

Q.6 A court poet of the Gupta period, Harishena, wrote a glowing account of the military exploits of his patron. Who was his patron?

- Ans**
- 1. Samudragupta
 - 2. Chandragupta I
 - 3. Chandragupta II
 - 4. Kumaragupta I

Q.7 International Day of Non-violence is marked on which of the following freedom fighter's birth anniversary?

- Ans
- 1. Lal Bahadur Shastri
 - 2. Mahatma Gandhi
 - 3. Jawaharlal Nehru
 - 4. BR Ambedkar

Q.8 Which of the following is NOT subject to dissolution?

- Ans
- 1. Legislative Assembly
 - 2. Legislative Council
 - 3. Cabinet
 - 4. Council Of Ministers

Q.9 During the Mughal period, what were the farmers called who cultivate their own land?

- Ans
- 1. Pahi Kasht
 - 2. Muzarain
 - 3. Zamindar
 - 4. Khud kashta

Q.10 The term 'secular' was added to the Preamble of the Constitution of India by the 42nd Constitutional Amendment Act in the year _____.

- Ans
- 1. 1976
 - 2. 1975
 - 3. 1978
 - 4. 1974

Q.11 As per Human Development Report 2021-22, what is the percentage of population under severe multi-dimensional poverty?

- Ans
- 1. 8.8%
 - 2. 51.3%
 - 3. 31.3%
 - 4. 41.3%

Q.12 WACA Cricket Ground is located in _____.

- Ans
- 1. Mumbai
 - 2. Sydney
 - 3. Perth
 - 4. London

Q.13 As per data released by Centre for Monitoring Indian Economy (CMIE) for the month of December 2022, _____ recorded the lowest unemployment at 0.9%.

- Ans
- 1. Haryana
 - 2. Odisha
 - 3. Madhya Pradesh
 - 4. Rajasthan

Q.14 Mauryan emperor Ashoka conquered Kalinga, which is currently known as _____.

- Ans
- 1. Bengal
 - 2. Uttar Pradesh
 - 3. Bihar
 - 4. Odisha

Q.15 Who among the following was NOT a gold medallist at the Commonwealth Games-2022?

- Ans
- 1. Pooja Gehlot
 - 2. Vinesh Phogat
 - 3. Naveen Kumar
 - 4. Ravi Dahiya

Q.16 Which of the following soil varieties is favourable for the growth of mangroves and deltaic vegetation?

- Ans
- 1. Laterite soil
 - 2. Fine clay and alluvial soil
 - 3. Desert soil
 - 4. Black soil

Q.17 Which of the following is NOT a feature of Fundamental Duties?

- Ans
- 1. They are not applicable to foreigners.
 - 2. They are both, civic and moral in nature.
 - 3. They emphasize on respecting Indian culture.
 - 4. They are justiciable.

Q.18 Prarthana Samaj was established at Bombay in the year _____.

- Ans
- 1. 1867
 - 2. 1737
 - 3. 1537
 - 4. 1937

Q.19 The ICAR-Central Institute for Cotton Research is located in _____.

- Ans
- 1. Hyderabad
 - 2. Bhopal
 - 3. Jaipur
 - 4. Nagpur

Q.20 U Srinivas is associated with which musical instrument?

- Ans
- 1. Violin
 - 2. Shehnai
 - 3. Kanjra
 - 4. Mandolin

Q.21 What is the general circulation of the atmosphere?

- Ans
- 1. The pattern of the movement of the energy.
 - 2. The pattern of the movement of the surface winds.
 - 3. The pattern of the movement of the planetary winds.
 - 4. The pattern of the movement of the water.

Q.22 Select the correct statement.

- Ans
- 1. The climate of Gangetic plains is very stable throughout the year.
 - 2. In the Southern peninsular region, the temperature difference is quite low between summers and winters.
 - 3. In the Thar desert, the temperature difference is quite low between summers and winters.
 - 4. The climate of the Northern Himalaya region is very hot and humid.

Q.23 Which of the following economic reforms were initiated by the government under their liberalisation policy?

- Ans**
- 1. Industrial and financial sector reforms
 - 2. Agricultural and financial sector reforms
 - 3. Industrial, agricultural and financial sector reforms
 - 4. Industrial and agricultural sector reforms

Q.24 Up to which financial year has the 'New India Literacy Programme' been launched to impart foundational literacy and numeracy, critical life skills, vocational skills, basic and continuing education?

- Ans**
- 1. FY 2025
 - 2. FY 2026
 - 3. FY 2029
 - 4. FY 2027

Q.25 Which Act of the Government of India ensures the 'right to work' from the following?

- Ans**
- 1. Indian Institutes of Management Act
 - 2. The Employees' Provident Funds and Miscellaneous Provisions Act
 - 3. Citizenship Act
 - 4. Mahatma Gandhi National Rural Employment Guarantee Act

Q.26 _____ originated in Kerala.

- Ans**
- 1. Sattriya
 - 2. Kathakali
 - 3. Kuchipudi
 - 4. Bharatnatyam

Q.27 Who among the following personalities is associated with Odissi dance?

- Ans**
- 1. Surupa Sen
 - 2. Jatin Goswami
 - 3. Ishira Parikh
 - 4. Yamini Krishnamurthy

Q.28 Which of the following was/were the limitation(s) of the Green Revolution?

- A. Confined to limited crops
B. Uneven spread

- Ans**
- 1. Neither A nor B
 - 2. Only A
 - 3. Only B
 - 4. Both A and B

Q.29 'A Passage to India', a novel about the British Empire, was written by which of the following authors?

- Ans**
- 1. James Joyce
 - 2. EM Forster
 - 3. Sinclair Lewis
 - 4. Anita Loos

Q.30 What was the approximate overall growth target in India's First Five-Year Plan?

- Ans**
- 1. 4.2%
 - 2. 3.5%
 - 3. 2.1%
 - 4. 1.3%

Q.31 Consider the following groups of elements:
A: $^{12}_6\text{C}$ and $^{14}_6\text{C}$ C: $^{40}_{16}\text{S}$ and $^{40}_{17}\text{Cl}$

B: $^{16}_8\text{O}$ and $^{18}_8\text{O}$ D: $^{14}_6\text{C}$ and $^{14}_7\text{N}$

Which of the following identifications regarding the given groups is correct?

- Ans
- 1. Isotopes: C and D
Isobars: A and B
 - 2. Isotopes: A and C
Isobars: B and D
 - 3. Isotopes: A and D
Isobars: B and C
 - 4. Isotopes: A and B
Isobars: C and D

Q.32 Uraiyur, a place famous for cotton, was the political centre (capital) of the:

- Ans
- 1. Cholas
 - 2. Pandyas
 - 3. Cheras
 - 4. Chalukyas

Q.33 Which type of title can be conferred by the state as per Article 18 of the Constitution of India?

- Ans
- 1. Religious and Music
 - 2. Sports and Music
 - 3. Military and Social
 - 4. Military and Academic

Q.34 In which of the following sessions of the Indian National Congress was the demand for 'Swaraj' put forward for the first time?

- Ans
- 1. Calcutta
 - 2. Bombay
 - 3. Bankipur
 - 4. Karachi

Q.35 Name the first Indian woman who became the President of the Indian National Congress.

- Ans
- 1. Sarala Devi Chaudhurani
 - 2. Rani Velu Nachiyar
 - 3. Sarojini Naidu
 - 4. Annie Besant

Q.36 The Swaran Singh Committee had suggested the incorporation of a total of _____ Fundamental Duties.

- Ans
- 1. 10
 - 2. 8
 - 3. 14
 - 4. 13

Q.37 Which genus of the Rhodophyceae family possesses an erect series of branches and a filamentous prostrate section attached to the substratum by means of unicellular rhizoids?

- Ans
- 1. Dictyota
 - 2. Laminaria
 - 3. Sargassum
 - 4. Polysiphonia

Q.38 As of October 2022, which of the following is a Stupa site excavated in the state of Karnataka?

- Ans
- 1. Sanchi
 - 2. Amravati
 - 3. Guntapalle
 - 4. Sannati

Q.39 Carbonated beverages contain _____.

- Ans
- 1. N₂
 - 2. CO₂
 - 3. CH₄
 - 4. O₂

Q.40 A pilot project of linking Self-Help-Groups with banks was launched by NABARD. The success of the pilot project resulted in the introduction of three radical innovations by RBI/NABARD. Which of the following is NOT one of them?

- Ans
- 1. Introduction of collateral-free lending
 - 2. Acceptance of informal groups as clients of banks – both, for savings and credit linkage
 - 3. Avoidance of action in the event of defaults
 - 4. Permission to lend to groups without specification of purpose/activity/project

Q.41 What is the full form of 'ICC'?

- Ans
- 1. International Committee for Cricket
 - 2. Internal Cricket Committee
 - 3. Indian Cricket Council
 - 4. International Cricket Council

Q.42 Pandit Ajoy Chakrabarty, who was conferred with Padma Bhushan in 2020, is a veteran vocalist of the _____ Gharana.

- Ans
- 1. Patiala
 - 2. Gwalior
 - 3. Rangeela
 - 4. Kirana

Q.43 Which statement gives the details of the estimated revenue and expenditure of the government?

- Ans
- 1. Income statement
 - 2. Balance sheet
 - 3. Balance of payments
 - 4. Annual financial statement

Q.44 'Files and Ranks' are used in which of the following games?

- Ans
- 1. Hockey
 - 2. Badminton
 - 3. Chess
 - 4. Cricket

Q.45 Which substance is fortified with calcium, Vitamin D and Vitamin B12?

- Ans
- 1. Eggs
 - 2. Cow's milk
 - 3. Dark green leafy vegetables
 - 4. Soy milk

Q.46 The terms, 'Aus', 'Aman' and 'Boro', are associated with which crop in West Bengal?

- Ans**
- 1. Maize
 - 2. Rice
 - 3. Tea
 - 4. Wheat

Q.47 Indian Foreign Services and Indian Revenue Services come under which type of Civil Service?

- Ans**
- 1. State services
 - 2. Multinational services
 - 3. Federal services
 - 4. Central services

Q.48 Tippi is a well-known dance of which of the following states?

- Ans**
- 1. Gujarat
 - 2. Madhya Pradesh
 - 3. Rajasthan
 - 4. Punjab

Q.49 Where is the headquarter of the WTO located?

- Ans**
- 1. Washington, D.C.
 - 2. New York
 - 3. Geneva
 - 4. Rome

Q.50 Matthew Hayden, former Australian cricketer, has written which of the following autobiographies?

- Ans**
- 1. Standing My Ground
 - 2. At the Close Play
 - 3. Playing it My Way
 - 4. The Test of My Life

Section : Reasoning

Prepare 50% Faster

Q.1 Select the figure from the options that can replace the question mark (?) and complete the given pattern.

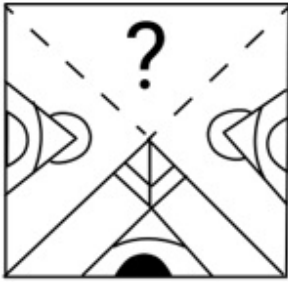

Ans

1.

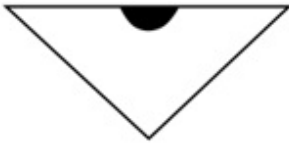

2.

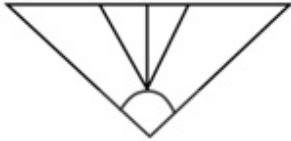

3.

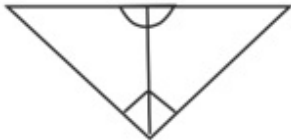

4.



Q.2 Select the correct mirror image of the given figure when the mirror is placed at MN as shown below.

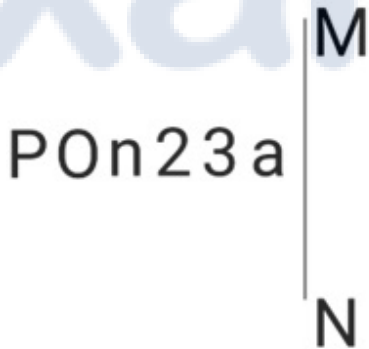

Ans

1.



2.



3.



4.



Q.3 Select the option figure that is embedded in the given figure. (Rotation is not allowed).

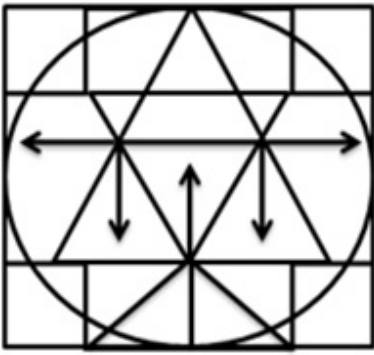

Ans

✗ 1.

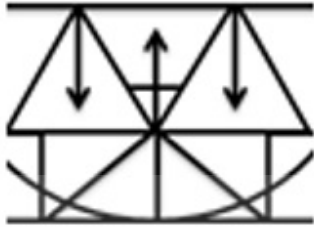

✗ 2.



✓ 3.

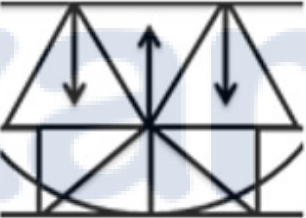

✗ 4.

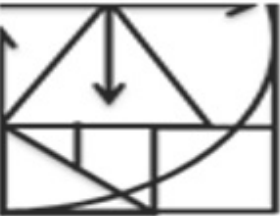

Q.4 P, Q, R, S, T, U and V are sitting in a straight row, facing north. V sits at the immediate left of P. U sits at the immediate right of Q. Only R sits between S and T. Only two persons sit to the right of S. P is to the immediate left of T. Who among the following is at the extreme right end of the row?

Ans

✗ 1. S

✗ 2. V

✗ 3. T

✓ 4. U

Q.5 Select the option that is related to the fourth term in the same way as the first term is related to the second term and the fifth term is related to the sixth term.

11 : 343 :: ? : 125 :: 7 : 27

Ans

✗ 1. 11

✗ 2. 13

✓ 3. 9

✗ 4. 10

Q.6 Select the option figure which is embedded in the given figure. (Rotation is NOT a

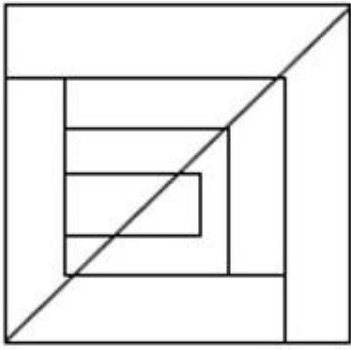

Ans

X 1.

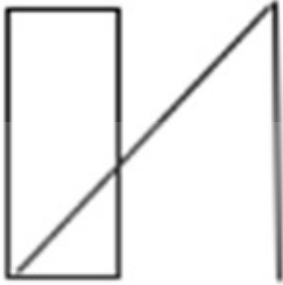

X 2.

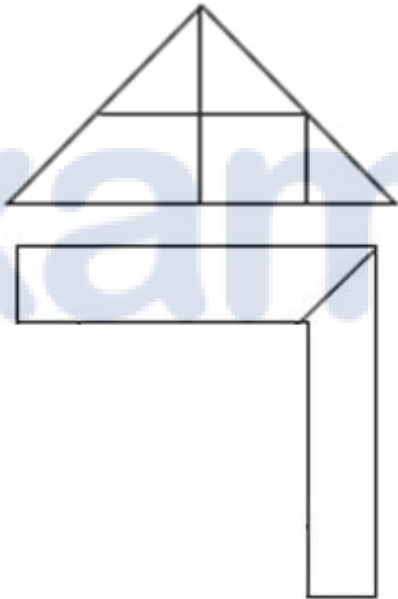

✓ 3.



X 4.



Q.7 Select the option in which the given figure is embedded (rotation is NOT allowed).



Ans

✗ 1.

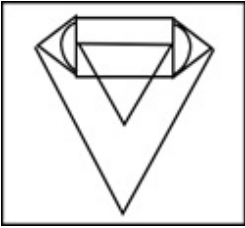

✗ 2.

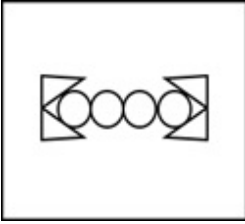

✓ 3.

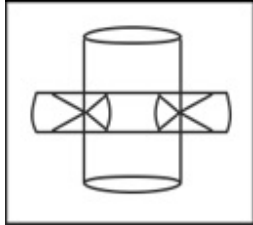

✗ 4.

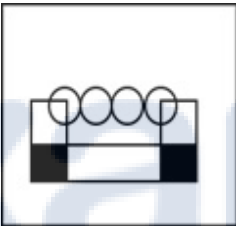

Prepare 50% Faster

Q.8 Select the correct mirror image of the given combination when the mirror is placed at 'MN' as shown below.

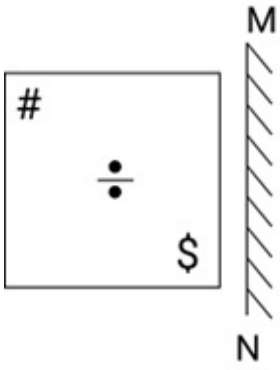

Ans

✗ 1.

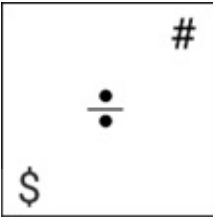

✓ 2.

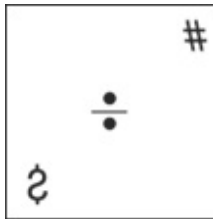

✗ 3.

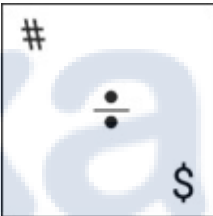

✗ 4.

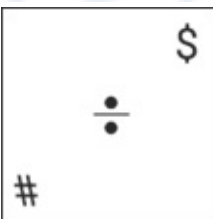

Q.9 How many triangles are there in the given figure?

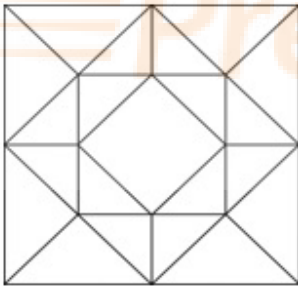

Ans

✗ 1. 30

✗ 2. 20

✓ 3. 28

✗ 4. 22

Q.10 Select the set in which the numbers are related in the same way as are the numbers of the following sets.
(NOTE : Operations should be performed on the whole numbers, without breaking down the numbers into its constituent digits. E.g. 13 – Operations on 13 such as adding /subtracting/multiplying etc. to 13 can be performed. Breaking 13 into 1 and 3 and then performing mathematical operations on 1 and 3 is not allowed)
(12, 34, 5)
(3, 18, 6)

- Ans**
- 1. (4, 30, 2)
 - 2. (2, 36, 4)
 - 3. (4, 5, 1)
 - 4. (2, 10, 3)

Q.11 Read the given statements and conclusions carefully. Assuming that the information given in the statements is true, even if it appears to be at variance with commonly known facts, decide which of the given conclusions logically follow(s) from the statements.

Statements:

All mangoes are grapes.

All grapes are guavas.

Conclusions:

I. All guavas are grapes.

II. All grapes are mangoes.

- Ans**
- 1. Only conclusion II follows
 - 2. Neither conclusion I nor II follows
 - 3. Only conclusion I follows
 - 4. Both conclusions I and II follow

Q.12 Select the option in which the given figure is embedded (rotation is NOT allowed).



Ans

- 1.
- 2.
- 3.
- 4.

Q.13 Select the option that is related to the third word in the same way as the second word is related to the first word. (The words must be considered as meaningful English words and must NOT be related to each other based on the number of letters/number of consonants/vowels in the word)
Notice : Ignore :: Expand:?

- Ans**
- 1. Bulky
 - 2. Condense
 - 3. Gentle
 - 4. Sharp

Q.14 Select the correct mirror image of the given combination when the mirror is placed at 'PQ' as shown below.

Z K 5 P V E | P
Q

- Ans
- 1. E V 2 P K Z
 - 2. E V P 2 K Z
 - 3. E V P 2 Z K
 - 4. E V P 2 Z K

Q.15 In a certain code language, 'CHILD' is written as '278113' and 'DRESS' is written as '31741818'. How will 'FIELD' be written in that language?

- Ans
- 1. 695124
 - 2. 584113
 - 3. 686132
 - 4. 573126

Q.16 Which figure should replace the question mark (?) if the following series were to be continued?

L U X Z Y U ♡ T ↑ Z	Z U ♡ T ↑	U Y P L T	T U Y P L	?
♡ ↑ L Y Y L Z ↑ ↑ Z				

- Ans
- 1. L P U Y Z
T ↑
 - 2. U ↑ Y Z P
T L
 - 3. U ↑ 3 Z P
T L
 - 4. L T U Y P
Z ↑

Q.17 Select the option figure that will replace the question mark (?) in the figure given below. 

Prepare 50% Faster

complete the pattern.



Ans

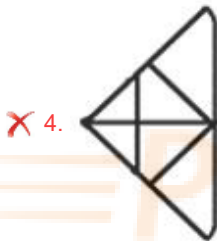
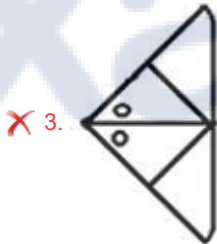
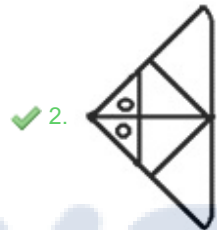
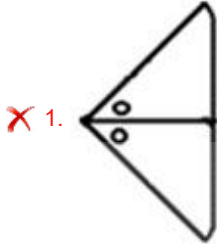

Q.18 If 'A' denotes '+', 'B' denotes 'x', 'C' denotes '-' and 'D' denotes '÷', then what will come in place of '?' in the following equation?

(21 B 3) C 33 D ? = 60

Ans ✗ 1. 13

✗ 2. 3

✓ 3. 11

✗ 4. 30

Q.19 Which of the following terms will replace the question mark (?) in the given series?

ZOJ, XMH, VKF, ?, RGB

Ans ✓ 1. TID

✗ 2. TED

✗ 3. TEP

✗ 4. DIT

Q.23 Which figure should replace the question mark (?) in the following series to continue the pattern?

T	U	S	U	T	7	K	7	T	7	K	S	
	K			S			U			T		?
6		7	K		6	6		S	U		6	

Ans

✓ 1.

U	S	K
	7	
6		T

✗ 2.

S	7	K
	U	
6		T

✗ 3.

K	S	T
	7	
6		U

✗ 4.

U	T	7
	K	
6		S

Prepare 50% Faster

Q.24

Which of the following option figures will complete the pattern in the figure given below?



Ans

X 1.



X 2.



✓ 3.



X 4.



Q.25 Select the option in which the given figure is embedded (rotation is NOT allowed).

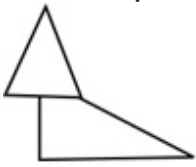

Ans

✓ 1.

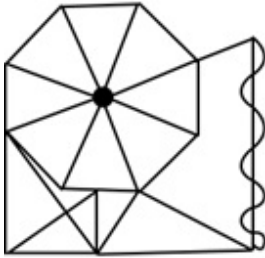

✗ 2.

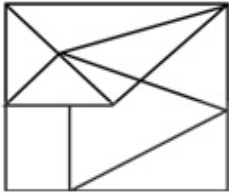

✗ 3.

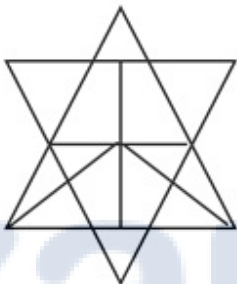

✗ 4.

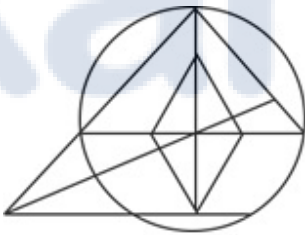

Section : Numerical Ability

Q.1 Find the greatest common divisor of 65, 75 and 90.

Ans ✗ 1. 3

✓ 2. 5

✗ 3. 15

✗ 4. 13

Q.2 For reaching at a dance class, Neelam walks at 5 km/h and reaches late by 10 min. If she increases her speed by 1 km/h, then she reaches 15 min early. Find the distance she travelled from her house to her destination.

Ans ✗ 1. 10.5 km

✓ 2. 12.5 km

✗ 3. 10 km

✗ 4. 5.5 km

Q.3 In how much time (in years) will a sum of ₹3,125 become ₹3,515.20 at 8% per annum, compounded half-yearly?

- Ans
- 1. $1\frac{1}{2}$
 - 2. $2\frac{1}{2}$
 - 3. 3
 - 4. 2

Q.4 Two banks, A and B, offered loans at rates 5.5% and 6.5% per annum, respectively. Ramesh borrowed an amount of ₹3,00,000 from each bank. The positive difference between the amounts of simple interest paid to the two banks by Ramesh after 2 years will be:

- Ans
- 1. ₹2,000
 - 2. ₹6,000
 - 3. ₹4,000
 - 4. ₹8,000

Q.5 A conical tent is required to accommodate 3 persons and each person needs 45 m^2 of space on the ground and 300 m^3 of air to breath. Find the vertical height of the tent (in m).

(Take $\pi = \frac{22}{7}$)

- Ans
- 1. 25
 - 2. 18
 - 3. 20
 - 4. 30

Q.6 The value of $\frac{0.2 \times 0.2 \times 0.2 + 0.5 \times 0.5 \times 0.5}{0.02 \times 0.02 \times 0.02 + 0.05 \times 0.05 \times 0.05}$ is:

- Ans
- 1. 100
 - 2. 5000
 - 3. 1000
 - 4. 10000

Q.7 If the cost price and selling price of an article are in the ratio of 13 : 17, then the percentage profit is:

- Ans
- 1. $30\frac{8}{13}\%$
 - 2. $30\frac{11}{13}\%$
 - 3. $30\frac{7}{13}\%$
 - 4. $30\frac{10}{13}\%$

Q.8 Simplify $\left[\left(2\frac{5}{13}\right)\% \text{ of } 9100 + \left(1\frac{1}{17}\right)\% \text{ of } 10200\right] + \frac{3}{5}(17 + 13)^{\frac{1}{3}}$.

- Ans
- 1. 7
 - 2. 9
 - 3. 14
 - 4. 11

Q.9 Find the area (in cm^2) of the triangle whose height is 48 cm and the base is $\frac{1}{6}$ the length of the height?

- Ans 1. 192
 2. 188
 3. 190
 4. 174

Q.10 3 men and 4 women can do a work in 7 days, whereas 2 men and 1 woman can do it in 14 days. 7 women will complete the same work in:

- Ans 1. 8 days
 2. 12 days
 3. 9 days
 4. 10 days

Q.11 If Basket A has 9 apples and 12 bananas, Basket B has 10 apples and 15 bananas, and Basket C has 8 apples and 16 bananas, then the ratios of apples and bananas in _____.

- Ans 1. Basket A < Basket B
 2. Basket A > Basket B
 3. Basket A = Basket C
 4. Basket A < Basket C

Q.12 The marked price of a commodity was ₹3,675. The seller offered a discount of 12% on its sale and incurred a loss of 2% as a consequence. What was the cost price (in ₹) of the commodity?

- Ans 1. 3300
 2. 3275
 3. 3280
 4. 3350

Q.13 Shashi sold her washing machine for ₹8,000; this was 60% increase in the value. What was the original price?

- Ans 1. ₹5,800
 2. ₹6,200
 3. ₹5,000
 4. ₹5,400

Q.14 In an election, there were two candidates Ram and Soham. The total number of voters in this constituency was 85800 and 80% of the total votes were polled. If 65% of the polled votes were cast in favour of Soham, how many votes were received by Ram?

- Ans 1. 34034
 2. 38038
 3. 26026
 4. 24024

Q.15 Find the average of all prime numbers between 15 and 30.

- Ans 1. 22
 2. 24
 3. 23
 4. 25

Q.1 In MS Excel 365, The basic syntax or symbol required to execute a function in MS-Excel is:

- Ans**
- 1. +
 - 2. :
 - 3. =
 - 4. \$

Q.2 What does the 'Grammar' check in Microsoft Word 365 primarily focus on?

- I. Spelling errors
- II. Sentence structure and syntax

- Ans**
- 1. Both I and II
 - 2. Only I
 - 3. Neither I nor II
 - 4. Only II

Q.3 In MS word 365 What does the 'Header' section in the 'Page Setup' dialog box allow you to do?

- Ans**
- 1. Change the line spacing of the document
 - 2. Add a header with text or page numbers to the top of each page
 - 3. Adjust the page margins
 - 4. Change the page orientation

Q.4 The shortcut key used to save the document in MS-Word 365 is:

- Ans**
- 1. Ctrl + X
 - 2. Ctrl + S
 - 3. Ctrl + A
 - 4. Ctrl + V

Q.5 Which function is used to display the current date in MS-excel 365?

- Ans**
- 1. DATE()
 - 2. DAY()
 - 3. TODAY()
 - 4. MONTH()

Q.6 Which of the following protocols is commonly used for sending and receiving emails between servers?

- Ans**
- 1. Transmission Control Protocol (TCP)
 - 2. Simple Mail Transfer Protocol (SMTP)
 - 3. Hyper Text Transfer Protocol (HTTP)
 - 4. File Transfer Protocol (FTP)

Q.7 Which of the following shortcut keys can be used to 'align right' the selected text in MS-Word 365?

- Ans**
- 1. Ctrl + U
 - 2. Ctrl + E
 - 3. Ctrl + J
 - 4. Ctrl + R

Q.8 Which of the following keyboard shortcuts is used to apply bullets in MS Word 365?

- Ans**
- 1. Ctrl + Shift + I
 - 2. Ctrl + Shift + C
 - 3. Ctrl + Shift + B
 - 4. Ctrl + Shift + L

Q.9 Which of the following folders has an unsolicited and unwanted junk email sent out in bulk to an indiscriminate r list?

- Ans**
- 1. Draft
 - 2. Spam folder
 - 3. Outbox
 - 4. Inbox

Q.10 In Microsoft Excel 365, which of the following is NOT done by Conditional Formatting?

- Ans**
- 1. We can delete condition if it is not required.
 - 2. We can set condition to look for bold and apply italics on them.
 - 3. We can apply font border and pattern formats that meet the specified conditions.
 - 4. We can add more than one condition to format.



Prepare 50% Faster

Constable Executive Male and Female in Delhi Police Examination 2023

Exam Date	02/12/2023
Exam Time	9:00 AM - 10:30 AM
Subject	Constable Executive Male and Female in Delhi Police Examination 2023

Section : General Knowledge

Q.1 What is the name of the phenomenon by which light splits into its component colours upon passing through a prism?

- Ans**
- 1. Diffraction
 - 2. Refraction
 - 3. Reflection
 - 4. Dispersion

Q.2 Khuallam and Cheraw are the dance forms of which of the following states?

- Ans**
- 1. Manipur
 - 2. Assam
 - 3. Tripura
 - 4. Mizoram

Q.3 Which of the following is the correct pair of autobiography and its autobiographer?

- Ans**
- 1. Long Walk to Freedom: Malcolm X
 - 2. On Writing: Ernest Hemingway
 - 3. Open: Anne Frank
 - 4. Mein Kampf: Adolf Hitler

Q.4 Which of the following neighbouring countries of India ranks the least in Human Development Index (HDI) 2021-22 among other countries?

- Ans**
- 1. Bangladesh
 - 2. Myanmar
 - 3. Afghanistan
 - 4. Pakistan

Q.5 The promotion and development of a strong banking system is the function of _____

- Ans**
- 1. regional rural bank
 - 2. central bank
 - 3. commercial bank
 - 4. foreign bank

Q.6 Which Indian American music composer received the ASCAP Screen Music Awards 2020 for his NBC's drama series 'This is Us'?

- Ans**
- 1. Mickey Singh
 - 2. Siddhartha Khosla
 - 3. Sid Sriram
 - 4. Paul Sabu

Q.7 On which of the following days, that is celebrated as a national festival, did India become a Sovereign, Democratic Republic state?

- Ans**
- 1. Gandhi Jayanti
 - 2. Martyr's Day
 - 3. Republic Day
 - 4. Independence Day

Q.8 Which of the following is an example of Pteridophytes?

- Ans**
- 1. Sphagnum
 - 2. Polytrichum
 - 3. Funaria
 - 4. Salvinia

Q.9 Which of the following fundamental duties is violated when a person purposefully spoils an ancient monument?

- Ans**
- 1. To protect the unity and integrity of India.
 - 2. To develop a scientific outlook and humanism.
 - 3. To defend the country when the need arises.
 - 4. To preserve our rich heritage and composite culture.

Q.10 The Majuli festival of North-East India is celebrated on the banks of which river?

- Ans**
- 1. Barak
 - 2. Luit
 - 3. Kolong
 - 4. Dhansiri

Q.11 Which Amendment Act established that Article 20 and 21 of the Constitution of India cannot be suspended, even in emergency?

- Ans**
- 1. 42nd Amendment Act
 - 2. 41st Amendment Act
 - 3. 44th Amendment Act
 - 4. 43rd Amendment Act

Q.12 In which of the following Articles of the Constitution of India is it mentioned that "it shall be the duty of every citizen of India to defend the country and render national service when called upon to do so"?

- Ans**
- 1. 51A (i)
 - 2. 51A (k)
 - 3. 51A (j)
 - 4. 51A (d)

Q.13 Which of the following trees are found in the Deciduous forests of India?

- Ans**
- 1. Mahogany
 - 2. Teak
 - 3. Rosewood
 - 4. Ebony

Q.14 Who among the following led the rebels in Kanpur in the revolt of 1857?

- Ans**
- 1. Kunwar Singh
 - 2. Nana Saheb Peshwa
 - 3. Birjis Qadr
 - 4. Tatya Tope

Q.15 Which of the following is NOT an important and direct contribution of a well-developed commercial banking sector?

- Ans
- 1. Capital formation
 - 2. Establishment of the agricultural market
 - 3. Mobilisation of savings
 - 4. Facilitation of successful implementation of the monetary policy

Q.16 Which of following states/union territories is a leading producer of saffron?

- Ans
- 1. Arunachal Pradesh
 - 2. Jammu and Kashmir
 - 3. Punjab
 - 4. Uttarakhand

Q.17 Kumudini Lakhia won the Padma Bhushan for which form of dance?

- Ans
- 1. Kathak
 - 2. Kuchipudi
 - 3. Kathakali
 - 4. Bharatnatyam

Q.18 Vivekananda Rock Memorial, a place of great scenic beauty, is located in _____, which has both historical and religious significance.

- Ans
- 1. Kanyakumari
 - 2. Mangalore
 - 3. Hyderabad
 - 4. Chennai

Q.19 भारत में लोगों के उस समूह के लिए किस शब्द उपयोग किया जाता है, जो हमेशा या सामान्य तौर पर निर्धन होते हैं लेकिन जिनके पास कभी-कभी थोड़ा-बहुत धन आ जाता है?

- Ans
- 1. चिरकालिक निर्धन (Chronic poor)
 - 2. अल्पकालिक निर्धन (Transient poor)
 - 3. निरंतर निर्धन (Churning poor)
 - 4. सापेक्ष निर्धन (Relative poor)

Q.20 Which of the following pairs is correctly matched?

- Ans
- 1. Dribble – Hockey
 - 2. Bicycle kick – Basketball
 - 3. Header – Hockey
 - 4. Third man – Cricket

Q.21 In which year was the Ranji Trophy cricket event series launched?

- Ans
- 1. 1955
 - 2. 1934
 - 3. 1930
 - 4. 1938

Q.22 Which of the following is NOT an example of a public sector industry in India?

- Ans
- 1. Tata Iron and Steel company
 - 2. National Thermal Power Corporation
 - 3. Bharat Heavy Electrical Limit
 - 4. Steel Authority of India Limit

Q.23 What percentage of the water that falls on land returns to the atmosphere through evaporation from over the ocean as from other places?

- Ans**
- 1. 49%
 - 2. 39%
 - 3. 29%
 - 4. 59%

Q.24 Which State has the maximum strength of members in Lok Sabha?

- Ans**
- 1. Maharashtra
 - 2. Uttar Pradesh
 - 3. Karnataka
 - 4. Andhra Pradesh

Q.25 In which type of sale minimum 51% of stake of PSE is sold to private sector ?

- Ans**
- 1. minority
 - 2. strategic
 - 3. standard
 - 4. mixed

Q.26 निम्नलिखित में से कौन सा नृत्य भिक्षुओं और लामाओं द्वारा मठों में बुरी आत्माओं को दूर करने के लिए किया जाता है?

- Ans**
- 1. कुल्लू नाटी
 - 2. छम
 - 3. राउफ
 - 4. हिकात

Q.27 What is the minimum age required for the appointment of a person as a governor?

- Ans**
- 1. 30 years
 - 2. 18 years
 - 3. 25 years
 - 4. 35 years

Q.28 According to Arthashastra, Megasthenes was a Greek ambassador sent by which of the following rulers?

- Ans**
- 1. Pericles
 - 2. Seleucus I Nicator
 - 3. Leonidas I
 - 4. Peisistratos

Q.29 What is the full form of IOA?

- Ans**
- 1. Indian Olympic Association
 - 2. Indian Olympic Amateur
 - 3. International Olympic Association
 - 4. India Olympic Association

Q.30 Which of the following is the key aspect of Constitutional bodies?

- Ans**
- 1. Made by the President and PM
 - 2. Temporary status
 - 3. Made by the Parliament
 - 4. Mentioned in the Constitution

Q.31 Which of the following movements was started by Khan Abdul Ghaffar Khan?

- Ans
- 1. Ghadhar Movement
 - 2. The Deccan Revolt
 - 3. Individual Satyagraha
 - 4. Khudai Khidmatgars

Q.32 निम्नलिखित में से कौन भारत में हरित क्रांति की शुरूआत से संबंधित नहीं है?

- Ans
- 1. वंदना शिवा
 - 2. एम.एस. स्वामीनाथन
 - 3. नॉर्मन बोरलॉग
 - 4. इंदर कुमार गुजराल

Q.33 'Transform rural poor youth into an economically independent and globally relevant workforce' is the vision of which rural livelihood mission?

- Ans
- 1. Pradhan Mantri Rozgar Yojana
 - 2. National Rural Employment Programme
 - 3. Deen Dayal Upadhyaya Grameen Kaushalya Yojana
 - 4. Employment Assurance Scheme

Q.34 Who was the first president of the All-India Trade Union Congress?

- Ans
- 1. NM Lokhande
 - 2. Lala Lajpat Rai
 - 3. MN Roy
 - 4. Lokmanya Tilak

Q.35 The first five year plan was presented to the parliament by which of the following personalities?

- Ans
- 1. Rajendra Prasad
 - 2. Jawaharlal Nehru
 - 3. Indira Gandhi
 - 4. PC Mahalanobis

Q.36 Courage and Conviction: An Autobiography, is written by whom among the following army generals turned politicians?

- Ans
- 1. Rajyawardhan Singh Rathod
 - 2. Joginder Jaswant Singh
 - 3. Vijay Kumar Singh
 - 4. Bhuwan Chandra Khanduri

Q.37 Which traditional dance of Goa is performed during the Shigmo festival?

- Ans
- 1. Kalbelia
 - 2. Morulem
 - 3. Lavani
 - 4. Jagar

Q.38 Who among the following Buddhist monks came from China to India during the reign of Chandragupta II?

- Ans
- 1. Fa-Hien
 - 2. Hiuen-Tsang
 - 3. Song Yun
 - 4. I-Tsing

Q.39 Consider the following statements with respect to the purpose of privatisation:

- (i) It improves financial discipline.
 - (ii) It facilitates modernization.
 - (iii) It helps in improving performance of the PSUs.
- Choose the correct answer.

- Ans
- 1. Only (i) is true
 - 2. Only (ii) is true
 - 3. Only (iii) is true
 - 4. All (i), (ii) and (iii) are true

Q.40 Which of the given statements about Phylum Angiosperms are correct?

- A. Angiosperms are non-vascular plants with stems, roots and leaves.
- B. The seeds of the angiosperm are naked.
- C. These make up the majority of all plants on earth.
- D. The seeds develop inside the plant organs and form fruit.

- Ans
- 1. Only B, C and D
 - 2. Only A and C
 - 3. Only A, B and C
 - 4. Only C and D

Q.41 राष्ट्रीय खेल-2022 में, 'सर्वश्रेष्ठ पुरुष एथलीट' (Best Male Athlete) के रूप में किसे चुना गया?

- Ans
- 1. शिव सुब्रमणि
 - 2. साजन प्रकाश
 - 3. जेसविन एल्ट्रिन
 - 4. राम बाबू

Q.42 Who among the following made significant contribution to the formation of Hindustan Socialist Republican Association (HSRA) in 1928?

- Ans
- 1. Bhagat Singh
 - 2. Lala Lajpat Rai
 - 3. Bal Gangadhar Tilak
 - 4. Subhash Chandra Bose

Q.43 Fundamental duties are narrated in which Article of the Indian Constitution?

- Ans
- 1. Article 51 (A)
 - 2. Article 42
 - 3. Article 16 (A)
 - 4. Article 21

Q.44 Indian music director AR Rahman won the Oscar in the year _____.

- Ans
- 1. 2011
 - 2. 2005
 - 3. 2008
 - 4. 2009

Q.45 Which of the following plutonic rocks is usually black or dark green in colour and is mainly composed of plagioclase and augite minerals?

- Ans
- 1. Zeolites
 - 2. Gabbro
 - 3. Quartzite
 - 4. Dolomite

Q.46 Who among the following was the author of Gita Govinda, composed during the reign of Lakshmana Sena?

- Ans**
- 1. Vatsyayana
 - 2. Jayadeva
 - 3. Vishakhadatta
 - 4. Somadeva

Q.47 Which of the following trophic levels has maximum energy?

- Ans**
- 1. Trophic level-3
 - 2. Trophic level-4
 - 3. Trophic level-2
 - 4. Trophic level-1

Q.48 The dance-pavilion (mandapa), the vast complex within a quadrilateral precinct of the Odisha school of architecture, is known as _____.

- Ans**
- 1. Deul
 - 2. Jagamohana
 - 3. Vimana
 - 4. Gopuram

Q.49 Which of the following Acts was replaced by the Competition Act 2002?

- Ans**
- 1. MRTP
 - 2. FERA
 - 3. LERMS
 - 4. FEMA

Q.50 The Lingayats community of present-day Karnataka originated in the 12th century CE due to the emergence of a movement led by _____.

- Ans**
- 1. Basavanna
 - 2. Sambandar
 - 3. Shivanaris
 - 4. Tevaram

Section : Reasoning

Q.1 Six friends, J, K, L, M, N and O, are sitting on a circular bench, facing away from the centre but not necessarily in the same order. O and J are the neighbours of N. M is sitting to the immediate right of J. L is sitting third to the left of N. Who is sitting second to the right of M?

- Ans**
- 1. K
 - 2. N
 - 3. L
 - 4. O

Q.2 Select the correct mirror image of the given figure when the mirror is placed at 'AB' as shown.



Ans

- 1. K 3 V x square triangle square 2 D
- 2. K 3 x V square triangle S D
- 3. K 3 x V square triangle 2 D
- 4. K 3 V x square triangle 2 D

Q.3 Which figure should replace the question mark (?) in the following series to continue the pattern?

Y O U T H	O A T B H	H O A T B	O C T S B	?
-----------	-----------	-----------	-----------	---

Ans

- 1. C T S B O
- 2. C O T B S
- 3. B O C T S
- 4. T O C B S

Q.4 Select the figure from among the given options that can replace the question mark (?) in the following series.

# + % * =	= * % + #	* # % = +	+ = % # *	?
-----------------	-----------------	-----------------	-----------------	---

(i) (ii) (iii) (iv) (v)

Ans

✓ 1.

= *	%
+ #	

✗ 2.

# +	%
= *	

✗ 3.

+ =	%
# *	

✗ 4.

= *	%
# +	

Q.5 Select the option that is related to the fifth letter-cluster in the same way as the second letter-cluster is related to the first letter-cluster and the fourth letter-cluster is related to the third letter-cluster.
SIGN : JCEO :: ONLY : UHJK :: MORE : ?

Ans ✗ 1. ANLJ

✗ 2. BNKI

✗ 3. BMLI

✓ 4. ANKI

Prepare 50% Faster

Q.6 A square sheet of paper is folded along the dotted line successively along the directions shown and is then punched last. How would the paper look when unfolded?

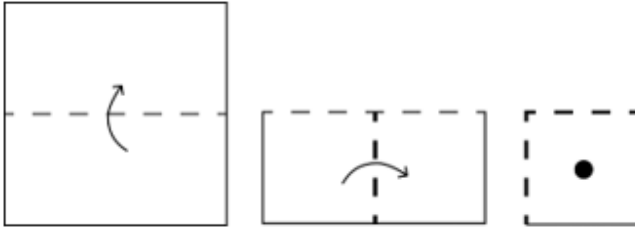

Ans

1.

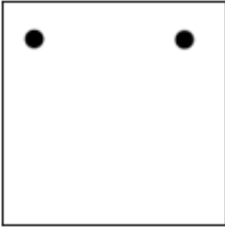

2.

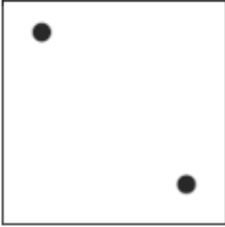

3.



4.

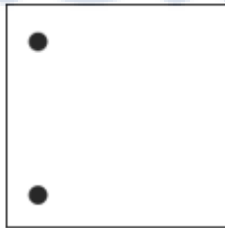

Q.7 How many cubes are there in the given figure?



1. 13

2. 11

3. 12

4. 10

Q.8 Three different positions of the same dice are shown. Find the number on the face opposite the face showing '6'.

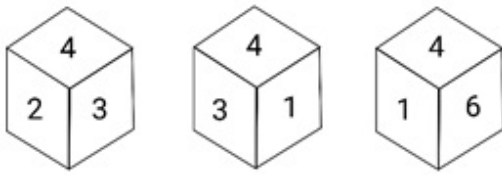

- Ans
- 1. 3
 - 2. 1
 - 3. 2
 - 4. 4

Q.9 Select the correct combination of mathematical signs that can sequentially replace the * signs and balance the given expression.

$$101 * 32 * 4 * 5 * 7 * 128$$

- Ans
- 1. +, ×, −, ÷, =
 - 2. −, ÷, +, ×, =
 - 3. ÷, +, ×, −, =
 - 4. −, ×, +, ÷, =

Q.10 Six numbers 1, 2, 3, 4, 5 and 6 are written on different faces of a dice. Two positions of this dice are shown in the figure. Find the number on the face opposite to 3.

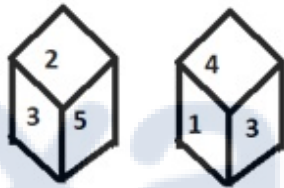

- Ans
- 1. 6
 - 2. 2
 - 3. 1
 - 4. 5

Q.11 Select the number from among the given options that can replace the question mark (?) in the following series.

$$5, 6, 8, 12, 20, ?$$

- Ans
- 1. 32
 - 2. 34
 - 3. 13
 - 4. 36

Q.12 Two statements are given, followed by three conclusions numbered I, II and III. Assuming the statements to be true, even if they seem to be at variance with commonly known facts, decide which of the conclusions logically follow(s) from the statements.

Statements:

All roses are lilies.

All lilies are flowers.

Conclusions:

I. All roses are flowers.

II. Some roses are not flowers.

III. No rose is a flower.

- Ans
- 1. Only conclusion III follows
 - 2. Either conclusion I or III follows
 - 3. Only conclusion II follows
 - 4. Only conclusion I follows

Q.13 Which two signs should be interchanged to make the given equation correct?
 $88 \div 4 - 15 \times 3 = 1 + 4$

- Ans
- 1. = and -
 - 2. = and \times
 - 3. = and +
 - 4. = and \div

Q.14 Which of the following option figures will complete the pattern in the figure given below?



Ans

- 1.
- 2.
- 3.
- 4.

Q.15 In a code language, if RIVER is coded as 9-18-5-22-9 and VALLEY is coded as 5-26-15-15-22-2, then how will MOUNTAIN be coded?

- Ans
- 1. 14-11-6-12-6-26-18-13
 - 2. 13-11-5-12-6-25-17-12
 - 3. 14-12-6-13-7-26-18-13
 - 4. 15-13-7-14-8-1-19-14

Q.16 Which figure should replace the question mark (?) if the series were to be continued?

△ Z E S O	O E Z △ S	E Z S D O	O S Z E D	?
--------------------	--------------------	--------------------	--------------------	---

Ans

✗ 1.

D O S X Z

✗ 2.

D Z S O E

✗ 3.

S Z D E O

✓ 4.

S Z D X O

Prepare 50% Faster

Q.17 Which of the following option figures will complete the pattern in the figure given below?



Ans



Q.18 Which of the following letter clusters will replace the question mark (?) in the given series to make it logically complete?
EHD, GJF, ILH, KNJ, ?

- Ans
- ✗ 1. MQL
 - ✗ 2. MPK
 - ✓ 3. MPL
 - ✗ 4. NPK

Q.19 Select the set in which the numbers are related in the same way as are the numbers of the following sets.
(NOTE : Operations should be performed on the whole numbers, without breaking down the numbers into its constituent digits. E.g. 13 – Operations on 13 such as adding/subtracting/multiplying etc. to 13 can be performed. Breaking down 13 into 1 and 3 and then performing mathematical operations on 1 and 3 is not allowed)
(30, 2, 3)
(100, 4, 5)

- Ans
- ✗ 1. (64, 4, 2)
 - ✗ 2. (120, 7, 3)
 - ✓ 3. (75, 3, 5)
 - ✗ 4. (100, 6, 4)

Q.20 Select the figure that can replace the question mark (?) in the following series.

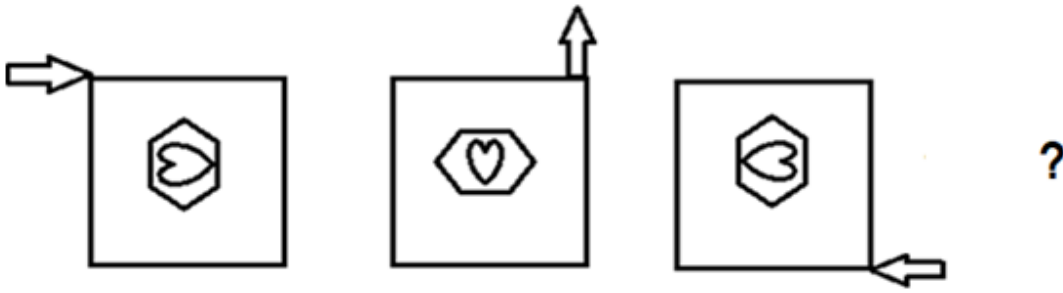

Ans

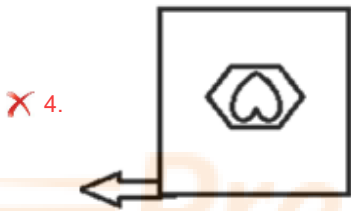
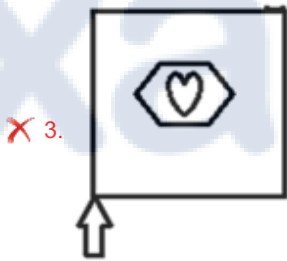
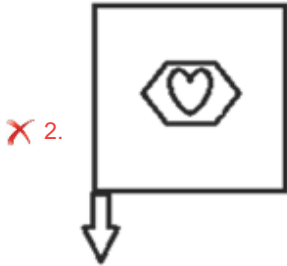
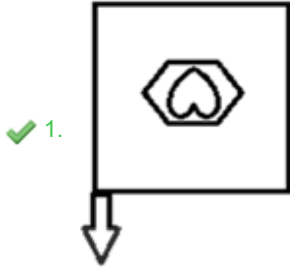

Q.21 Select the correct mirror image of the given figure when the mirror is placed at MN as shown below.

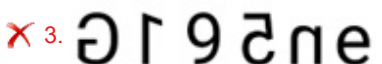
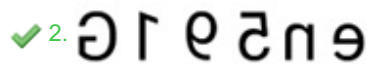
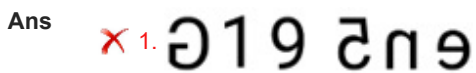
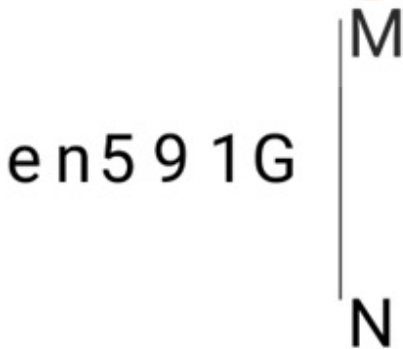

Q.22 1 is related to 24 following a certain logic. Following the same logic, 16 is related to 84. To which of the following related, following the same logic?
 (NOTE: Operations should be performed on the whole numbers, without breaking down the numbers into its con: digits. E.g. 13 – Operations on 13 such as adding/subtracting/multiplying etc. to 13 can be performed. Breaking down 13 into 1 and 3 and then performing mathematical operations on 1 and 3 is not allowed.)

- Ans
- ✗ 1. 112
 - ✗ 2. 108
 - ✓ 3. 104
 - ✗ 4. 98

Q.23 Select the option figure which is embedded in the given figure. (Rotation is not allowed.)

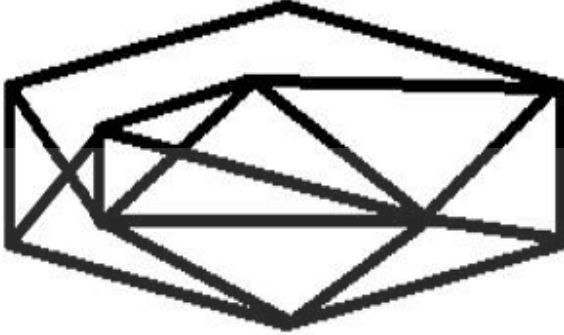

Ans

- ✗ 1.
- ✗ 2.
- ✓ 3.
- ✗ 4.

Q.24 Select the correct mirror image of the given figure when the mirror is placed at MN as shown in  Prepare 50% Faster

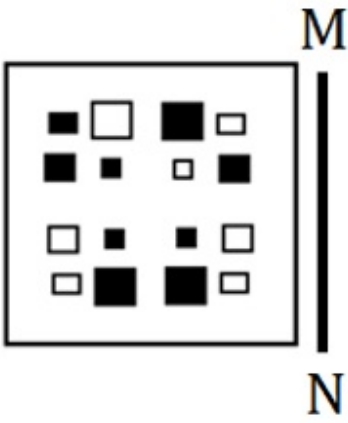

Ans

✗ 1.

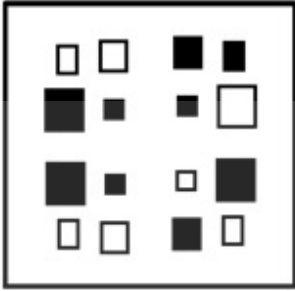

✓ 2.



✗ 3.

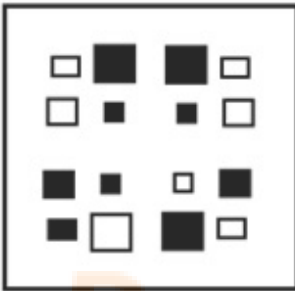

✗ 4.

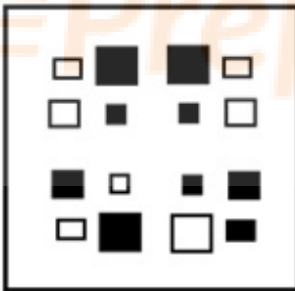

Q.25 A square sheet of paper is folded along the dotted line successively along the directions shown and is then punched last. How would the paper look when unfolded?

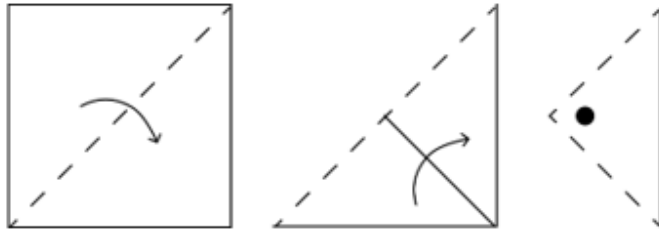

Ans

1.

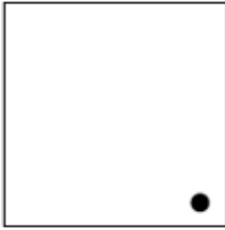

2.

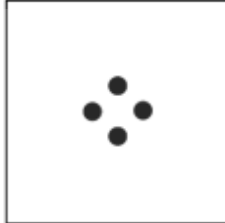

3.



4.

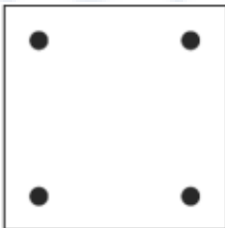

Section : Numerical Ability

Q.1 Find the number of coins, 0.2 cm thick and 2 cm in diameter, to be melted to form a right circular cylinder of height 12 cm and diameter 5 cm.

Ans 1. 470

2. 425

3. 375

4. 405

Q.2 A hemispherical bowl has 7 cm radius. It is to be painted inside as well as outside. The cost (in ₹) of painting it at the rate of ₹6 per 4 cm^2 is: (Take $\pi = \frac{22}{7}$)

Ans 1. 785

2. 880

3. 980

4. 924

Q.3 If the average of ten numbers is 16.2 and if 3 is subtracted from each number, then the new average of the ten numbers is:

- Ans
- 1. 13.2
 - 2. 15.1
 - 3. 14.3
 - 4. 16.1

Q.4 If the numerator of a fraction is increased by 17% and its denominator is decreased by 12%, the value of the fraction is $\frac{39}{44}$. What is the original fraction?

- Ans
- 1. $\frac{2}{3}$
 - 2. $\frac{3}{7}$
 - 3. $\frac{1}{3}$
 - 4. $\frac{7}{8}$

Q.5 What is the percentage change in the population if the total number of persons was 245000 in 2021 and 294000 in 2022?

- Ans
- 1. 15% increase
 - 2. 22% increase
 - 3. 20% increase
 - 4. 16.67% decrease

Q.6 If $\frac{p}{q} = 0.5$, then $\frac{3p-q}{3p+q}$ is:

- Ans
- 1. $\frac{1}{3}$
 - 2. $\frac{1}{2}$
 - 3. $\frac{1}{5}$
 - 4. $\frac{1}{4}$

Q.7 The difference between the CI and SI on a certain sum of money for 3 years at 4% percent per annum is ₹152. Find the sum invested.

- Ans
- 1. ₹31,250
 - 2. ₹31,200
 - 3. ₹31,225
 - 4. ₹31,275

Q.8 At simple interest, a certain sum of money amounts to ₹1,250 in 2 years and to ₹2,000 in 5 years. The rate of interest per annum (rounded off to two places of decimal) is:

- Ans
- 1. 16.67%
 - 2. 33.33%
 - 3. 27.27%
 - 4. 11.11%

Q.9 Find the greatest number by which, when the numbers 47, 95 and 187 are divided, it leaves the same remainder in case.

- Ans
- 1. 4
 - 2. 6
 - 3. 8
 - 4. 2

Q.10 An athlete crosses a distance of 1800 m in 12 minutes. What is his speed in km per hour?

- Ans
- 1. 9
 - 2. 8
 - 3. 6
 - 4. 7

Q.11 A alone can finish a work in 12 days and B can finish it in 18 days. If they work together and finish it, then out of the total of ₹6,000, A will get:

- Ans
- 1. ₹2,400
 - 2. ₹3,800
 - 3. ₹3,200
 - 4. ₹3,600

Q.12 5 अंकों की सबसे छोटी अभाज्य संख्या कौन-सी है?

- Ans
- 1. 10001
 - 2. 10007
 - 3. 10003
 - 4. 10009

Q.13 Mohit purchased a table for ₹3,500 and due to some scratches on it top, he sold it for ₹3,200. What is his loss percentage (rounded off to two decimals)?

- Ans
- 1. 8.57%
 - 2. 8.55%
 - 3. 8.56%
 - 4. 8.58%

Q.14 A trader marked his goods at 12% above the cost price. He sold half the stock at the marked price, one quarter at a discount of 12% on the marked price and the rest at a discount of 30% on the marked price. His total gain is:

- Ans
- 1. 0.24%
 - 2. 1.24%
 - 3. 1.85%
 - 4. 0.79%

Q.15 The salaries of P, Q and R are in the ratio 3:4:6. If R's salary is ₹15,000 more than that of P, then Q's salary is:

- Ans
- 1. ₹30,000
 - 2. ₹25,000
 - 3. ₹20,000
 - 4. ₹35,000

Q.1 In MS Word 365 which of the following shortcut keys is used to go to the beginning of the document?

- Ans**
- 1. Ctrl + Del
 - 2. Ctrl + End
 - 3. Ctrl + Home
 - 4. Ctrl + Ins

Q.2 What do you mean by LAN?

- Ans**
- 1. Live Area Network
 - 2. Local Area Network
 - 3. Local Around Network
 - 4. Last Active Network

Q.3 In MS-Word 365, what is the purpose of the 'Tell me what you want to do' feature in the Help menu?

- Ans**
- 1. It provides a list of recent documents for quick access.
 - 2. It allows you to search for specific commands and features within the application.
 - 3. It automatically corrects formatting errors in the document.
 - 4. It offers grammar and spelling suggestions for the selected text.

Q.4 Which of the following is used to save text temporarily when it is copied or cut in MS word 365?

- Ans**
- 1. Memoryboard
 - 2. Copyboard
 - 3. Clipboard
 - 4. Textboard

Q.5 निम्नलिखित में से किसका उपयोग तब किया जाता है, जब प्रेषक नहीं चाहता कि एक या अधिक प्राप्तकर्ताओं को पता चले कि संदेश किसी और को कॉपी किया गया था?

- Ans**
- 1. From
 - 2. BCC
 - 3. CC
 - 4. To

Q.6 What is the purpose of the 'Help' feature in Microsoft Word 365?

- Ans**
- 1. It allows you to print the current document.
 - 2. It provides assistance and information about using Microsoft Word.
 - 3. It opens a new blank document.
 - 4. It creates a backup copy of the document.

Q.7 In Microsoft Excel 365, what is the cell address of the intersection between column L and row 26?

- Ans**
- 1. L26
 - 2. 125L
 - 3. 26L
 - 4. L125

Q.8 In MS Excel 365, which of the following is the correct way to address the cell located in the third row and fifth column?

- Ans**
- 1. 5A
 - 2. 35
 - 3. 3A
 - 4. E3

Q.9 In MS Excel 365, which of the following keyboard shortcuts opens the Print option?

- Ans
- 1. Ctrl + Alt + P
 - 2. Shift + P
 - 3. Ctrl + P
 - 4. Alt + P

Q.10 Which of the following options can be used in MS Word 365 if you want to save your document in another location with the same or different name?

- Ans
- 1. Print
 - 2. Open
 - 3. New
 - 4. Save As



Prepare 50% Faster

Constable Executive Male and Female in Delhi Police Examination 2023

Exam Date	02/12/2023
Exam Time	12:00 PM - 1:30 PM
Subject	Constable Executive Male and Female in Delhi Police Examination 2023

Section : General Knowledge

Q.1 In which year did India and Maldives sign a trade agreement which provides for export of vital commodities?

- Ans
- 1. 1984
 - 2. 1981
 - 3. 2001
 - 4. 2003

Q.2 Ranjeet Singh belonged to which Misal of the Sikh community?

- Ans
- 1. Bhangi
 - 2. Kanhaiya
 - 3. Sukarchakia
 - 4. Ahluwalia

Q.3 तीरंदाजी में, तीन तीरों को लक्ष्य पर मारने के लिए अधिकतम कितने समय की अनुमति होती है?

- Ans
- 1. 2 मिनट
 - 2. 8 मिनट
 - 3. 7 मिनट
 - 4. 5 मिनट

Q.4 The first ICC Men's T20 Cricket World Cup was won by _____.

- Ans
- 1. Australia
 - 2. India
 - 3. West Indies
 - 4. England

Q.5 The first electric train ran in which state of India in the year 1925?

- Ans
- 1. Maharashtra
 - 2. Rajasthan
 - 3. West Bengal
 - 4. Haryana

Q.6 शुरुआत में मगध महाजनपद की राजधानी निम्नलिखित में से कौन-सी थी?

- Ans
- 1. राजगृह
 - 2. वैशाली
 - 3. विक्रमशिला
 - 4. पाटलिपुत्र

Q.7 Which dynasty ruled after the Tuglaq dynasty?

- Ans
- 1. Sayyid dynasty
 - 2. Lodi dynasty
 - 3. Mamluk dynasty
 - 4. Khalji dynasty

Q.8 एक सत्तारूढ़ शक्ति के रूप में चोल 9वीं शताब्दी ईस्वी में प्रतिष्ठित हो गए, जब _____ ने तंजावुर को पल्लवों के एक सामंती प्रमुख मुत्तरायस से जब्त कर लिया।

- Ans
- 1. उत्तम चोल
 - 2. राजराज चोल।
 - 3. परांतक।
 - 4. विजयालय

Q.9 Name a genus of widely distributed floating aquatic plants that is the smallest monocot plant known to date and has the highest total protein content.

- Ans
- 1. Wolffia
 - 2. Azolla
 - 3. Water Hyacinth
 - 4. Pistia

Q.10 संघीय ढाँचा, न्यायपालिका, राज्यपाल प्रणाली और आपातकाल लगाने की शक्तियाँ - भारतीय संविधान की ये विशेषताएँ _____ से ली गई हैं।

- Ans
- 1. 1935 के भारत सरकार अधिनियम
 - 2. 1947 के भारतीय स्वतंत्रता
 - 3. 1919 के भारत सरकार अधिनियम
 - 4. 1909 के भारत सरकार अधिनियम

Q.11 Fort of Kushalghadh is located in which Indian state?

- Ans
- 1. Madhya Pradesh
 - 2. Maharashtra
 - 3. Chhattisgarh
 - 4. Uttar Pradesh

Q.12 The 97th Constitutional Amendment Act of 2011 has added a new Directive Principle of State Policy related to:

- Ans
- 1. Maternity Leave
 - 2. Environment
 - 3. Cooperative Societies
 - 4. Child Labour

Q.13 Against which oppressive law did Mahatma Gandhi launch a movement in 1919 that made him a truly national leader?

- Ans
- 1. Rowlatt Act
 - 2. Morley Minto Reforms
 - 3. Vernacular Press Act
 - 4. Salt Tax

Q.14 What is the common biological phenomenon by which one organism produces biochemicals that influence the growth, survival, development, and reproduction of other organisms known as?

- Ans
- 1. Allopathy
 - 2. Allotropy
 - 3. Allelopathy
 - 4. Allelomorph

Q.15 Under the Liberalisation Policy, a lot of industries were reserved for the public sector. Which of the following industries are still reserved under public sector?

- Ans**
- 1. Coal and Mineral Oils
 - 2. Atomic and Railway Operations
 - 3. Copper and zinc
 - 4. Hazardous Chemicals and Alcohol

Q.16 In Olympic archery events, how many concentric rings are there which represent different scoring sectors?

- Ans**
- 1. 2
 - 2. 10
 - 3. 7
 - 4. 5

Q.17 As per the Indus Water Treaty 1960, how much per cent water can India use from the river?

- Ans**
- 1. 22
 - 2. 28
 - 3. 25
 - 4. 20

Q.18 सूर्य सेन अंग्रेजों के खिलाफ निम्नलिखित में से किस कट्टरपंथी गतिविधियों से जुड़े थे?

- Ans**
- 1. चटगांव शस्त्रागार छापा
 - 2. मुजफ्फरपुर षडयंत्र केस
 - 3. दिल्ली षडयंत्र केस
 - 4. काकोरी षडयंत्र

Q.19 How many industries have been reserved for the public sector under the Industrial Policy Resolution, 1956?

- Ans**
- 1. 15
 - 2. 2
 - 3. 21
 - 4. 17

Q.20 Which of the following Articles of the Indian Constitution deals with fundamental duties?

- Ans**
- 1. Article 41
 - 2. Article 41A
 - 3. Article 71
 - 4. Article 51A

Q.21 पद्म श्री 2021 से सम्मानित रामचंद्र मांझी को कला में निम्नलिखित में से किस योगदान के लिए पुरस्कार से सम्मानित किया गया था?

- Ans**
- 1. प्राचीन कर्नाटकी संगीत वाद्ययंत्रों के संरक्षण
 - 2. ग्रामीण नाटक और लोक नृत्य की विरासत को आगे बढ़ाने
 - 3. आदिवासी किन्नरों के वादन और लोक गायन
 - 4. शहनाई को कर्नाटकी संगीत के अनुकूल बनाने

Q.22 'Lai Haraoba' is a style of which of the following Classical dances of India?

- Ans**
- 1. Manipuri
 - 2. Odissi
 - 3. Kathak
 - 4. Kathakali

Q.23 चिदंबरम मंदिर के गोपुरम में किस नृत्य शैली की कई मुद्राएं हैं?

- Ans
- 1. कुचिपुड़ी
 - 2. भरतनाट्यम
 - 3. ओडिसी
 - 4. कथकली

Q.24 राज्य विधान-परिषद के _____ सदस्यों को राज्य के राज्यपाल द्वारा मनोनीत किया जाता है।

- Ans
- 1. 1/9
 - 2. 1/15
 - 3. 1/6
 - 4. 1/12

Q.25 Which of the following is NOT a 'Navratna' or 'Maharatna' company in India?

- Ans
- 1. Indian Oil Corporation
 - 2. Oil & Natural Gas Corporation
 - 3. Industrial Finance Corporation of India
 - 4. National Thermal Power Corporation

Q.26 From which country is the power of judicial review taken in the Indian Constitution?

- Ans
- 1. United Kingdom
 - 2. United States of America
 - 3. Japan
 - 4. France

Q.27 Which of the following state High Court's jurisdiction extends to the Union Territories of Daman and Diu?

- Ans
- 1. Kerala High Court
 - 2. Guwahati High Court
 - 3. Bombay High Court
 - 4. Calcutta High Court

Q.28 निम्नलिखित में से किस शासक ने प्राचीन भारत में दक्कन में सातवाहन साम्राज्य को मजबूत किया?

- Ans
- 1. गौतमीपुत्र शातकर्णी
 - 2. शिव स्कंद शातकर्णी
 - 3. सिमुका
 - 4. यज्ञ श्री शातकर्णी

Q.29 Read the below statements and select the correct option with respect to self-help groups.

- (i) A self-help group is a registered group of micro-entrepreneurs.
(ii) The micro-entrepreneurs of self-help groups have similar social and economic backgrounds.

- Ans
- 1. Both (i) and (ii) are false
 - 2. Only (ii) is true
 - 3. Both (i) and (ii) are true
 - 4. Only (i) is true

Q.30 On the first Republic Day, 26 January 1950, the Constitution of India replaced which British Act?

- Ans
- 1. Government of India Act (1919)
 - 2. Government of India Act (1935)
 - 3. Government of India Act (1930)
 - 4. Government of India Act (1858)

Q.31 Which of the following statements is INCORRECT with regard to microfinance?

- Ans
- 1. Microfinance initiative in India was taken by NABARD.
 - 2. The Reserve Bank of India had appointed the Malegam Committee to go into the regulation of microfinance institutions
 - 3. Microfinance in India evolved to fill the gaps created by the formal banking institutions.
 - 4. Microfinancing started in India majorly due the nationalisation of banks.

Q.32 बाघ का गुफा स्थल भारत के किस राज्य में स्थित है?

- Ans
- 1. मध्य प्रदेश
 - 2. महाराष्ट्र
 - 3. ओडिशा
 - 4. उत्तर प्रदेश

Q.33 Which of the following is the most reactive metal?

- Ans
- 1. Mercury
 - 2. Lead
 - 3. Zinc
 - 4. Magnesium

Q.34 Taxes levied on commodities are known as which types of taxes?

- Ans
- 1. Indirect taxes
 - 2. Direct taxes
 - 3. Both direct and indirect taxes
 - 4. Corporation taxes

Q.35 स्वतंत्रता के प्रारंभिक वर्षों में राज्य के पास उन उद्योगों का पूर्ण नियंत्रण था, जो _____ थे।

- Ans
- 1. केवल निजी क्षेत्र की नीतियों के पूरक
 - 2. संरचना के आधार पर लाभदायक नहीं
 - 3. अर्थव्यवस्था के लिए अप्रासंगिक
 - 4. अर्थव्यवस्था के लिए महत्वपूर्ण

Q.36 निम्नलिखित में से किस वर्ष में महाराष्ट्र के सतारा में युवा नेताओं ने एक समानांतर सरकार पार्टी की स्थापना की, जो लोगों की अदालत चलाती थी और रचनात्मक कार्य आयोजित करती थी?

- Ans
- 1. 1943
 - 2. 1918
 - 3. 1934
 - 4. 1904

Q.37 Which of the following is a watershed development scheme of the Ministry of Rural Development of India?

- Ans
- 1. Hariyali
 - 2. Khushali
 - 3. Dam construction
 - 4. Digging hand-pump wells

Q.38 Which of the following states showed highest levels of poverty, in the 2011 census?

- Ans
- 1. Bihar
 - 2. Maharashtra
 - 3. Uttar Pradesh
 - 4. Karnataka

Q.39 By which of the following authors was the English novel 'Jude the Obscure' written?

- Ans
- 1. Thomas Hardy
 - 2. Arthur Conan Doyle
 - 3. Jane Austen
 - 4. Charlotte Bronte

Q.40 The first edition of the Khelo India University Games was hosted in which of the following years?

- Ans
- 1. 2021
 - 2. 2019
 - 3. 2020
 - 4. 2018

Q.41 'West Meets East' is an album by American violinist Yehudi Menuhin and Indian sitar virtuoso _____.

- Ans
- 1. Prem Joshua
 - 2. Shahed Parvez
 - 3. Vilayat Khan
 - 4. Ravi Shankar

Q.42 For which of the following dance forms was Kamalini Asthana awarded the Padma Shri in 2022?

- Ans
- 1. Odissi
 - 2. Kathak
 - 3. Kuchipudi
 - 4. Sattriya

Q.43 According to the census of India 2011, identify the state in which 'Total Literacy Rate' and 'Male Literacy Rate' both were more than 90%?

- Ans
- 1. Tripura
 - 2. Himachal Pradesh
 - 3. Goa
 - 4. Mizoram

Q.44 Which elements act as hygroscopic nuclei around which water vapour condenses to produce clouds?

- Ans
- 1. Dust and sea salt
 - 2. Water and dust
 - 3. Salt and water
 - 4. Dust and rock

Q.45 'The Race of My Life: An Autobiography' is written by which Indian athlete?

- Ans
- 1. PT Usha
 - 2. Shivnath Singh
 - 3. Milkha Singh
 - 4. Hima Das

Q.46 सीढ़ीदार खेती आमतौर पर भारत के निम्नलिखित में से किस क्षेत्र में की जाती है?

- Ans
- 1. हिमालय क्षेत्र
 - 2. गंगा के मैदानों
 - 3. तटवर्ती मैदान
 - 4. थार रेगिस्तान

Q.47 When is the Maru Mahotsava at Jaisalmer held?

- Ans
- 1. November-December
 - 2. January-February
 - 3. March-April
 - 4. September-October

Q.48 What is/are known as enzymes?

- Ans
- 1. Biological catalysts
 - 2. Physical activity
 - 3. Receptors
 - 4. Substrates

Q.49 भारतीय संविधान का निम्नलिखित में से कौन-सा अनुच्छेद सर्वोच्च न्यायालय को अभिलेख न्यायालय घोषित करता है?

- Ans
- 1. अनुच्छेद 126
 - 2. अनुच्छेद 125
 - 3. अनुच्छेद 128
 - 4. अनुच्छेद 129

Q.50 Budhaditya Mukharjee, Vilayat Khan and Mustaq Ali Khan are associated with which musical instrument?

- Ans
- 1. Sarod
 - 2. Santoor
 - 3. Surbahar
 - 4. Sitar

Section : Reasoning

Q.1 Select the figure from among the given options that can replace the question mark (?) in the following series.

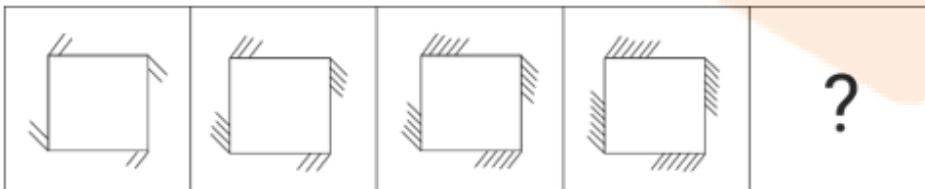

Ans

- 1.
- 2.
- 3.
- 4.

Q.2 Six numbers 3, 2, 5, 1, 7 and 6 are written on different faces of a dice. Two positions of this dice are shown in the figure. The number on the face opposite to 5.

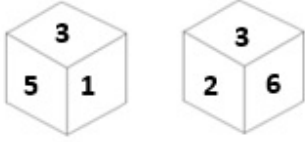

- Ans
- 1. 3
 - 2. 2
 - 3. 6
 - 4. 1

Q.3 Select the set in which the numbers are related in the same way as are the numbers of the following sets.
(NOTE: Operations should be performed on the whole numbers, without breaking down the numbers into its constituent digits. E.g. 13 – Operations on 13 such as adding/deleting/multiplying etc. to 13 can be performed. Breaking down 13 into 1 and 3 and then performing mathematical operations on 1 and 3 is not allowed)
(13, 40, 115)
(5, 16, 43)

- Ans
- 1. (6, 19, 72)
 - 2. (11, 34, 97)
 - 3. (7, 22, 71)
 - 4. (9, 26, 73)

Q.4 Select the option that is related to the fifth letter-cluster in the same way as the second letter-cluster is related to the first letter-cluster and the fourth letter-cluster is related to the third letter-cluster.
HEAD : IGDH :: HAND : ICQH :: BACK : ?

- Ans
- 1. DCFO
 - 2. CDFO
 - 3. CCFO
 - 4. CCEO

Prepare 50% Faster

Q.5 Which of the following option figures will complete the pattern in the figure given below?



Ans



Q.6 Select the number from among the given options that can replace the question mark (?) in the following series.

5, 12, 40, 152, 600, ?

Ans X 1. 4344

✓ 2. 2392

X 3. 3123

X 4. 3233

Q.7 Which of the following option figures will complete the pattern in the figure given below?



Ans

- 1.
- 2.
- 3.
- 4.

Q.8 How many squares are there in the following figure?

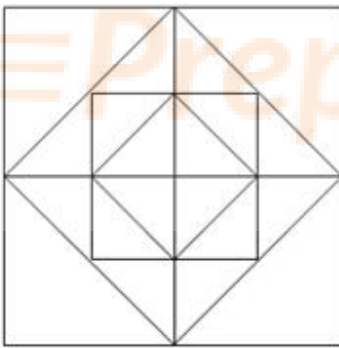

- 1. 14
- 2. 12
- 3. 16
- 4. 10

Q.9 Select the option that is related to the fourth term in the same way as the first term is related to the second term :
term is related to the sixth term.
 $18 : 27 :: ? : 36 :: 16 : 24$

- Ans
- 1. 23
 - 2. 42
 - 3. 32
 - 4. 24

Q.10 Select the correct mirror image of the given figure when the mirror is placed at MN as shown below.

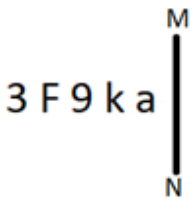

- Ans
- 1. ɹ 9 k Ɔ ɛ
 - 2. ɹ Ɔ k 9 ɛ
 - 3. a k 9 Ɔ ɛ
 - 4. ɹ Ɔ k 9 ɛ

Q.11 Select the option figure that is embedded in the given figure. (Rotation is not allowed).

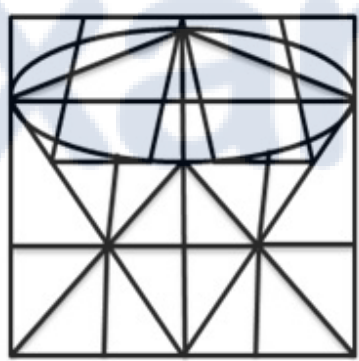

- Ans
- 1.
 - 2.
 - 3.
 - 4.

Q.12 Which of the following option figures will complete the pattern in the figure given below?



Ans

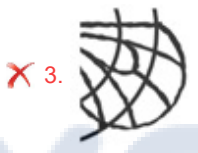
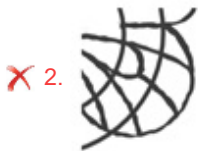
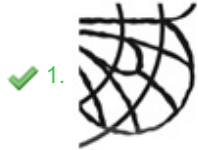

Q.13 Six letters A, B, C, P, Q and R are written on different faces of a dice. Two positions of this dice are shown in the figure. Find the letter on the face opposite to Q.

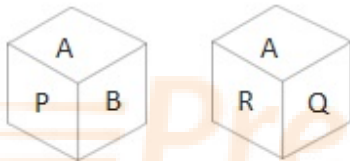

- Ans
- ✗ 1. R
 - ✗ 2. C
 - ✓ 3. B
 - ✗ 4. P

Q.14 Select the correct combination of mathematical signs to sequentially replace the * signs and to balance the given equation.
 $32 * 6 * 12 * 67 * 2 = 81$

- Ans
- ✓ 1. $\times, \div, +, -$
 - ✗ 2. $\div, -, \times, +$
 - ✗ 3. $-, \times, \div, -$
 - ✗ 4. $+, \times, -, \div$

Q.15 Seven people, P, Q, R, S, T, U and V, are sitting in a straight row facing north. Only two people sit to the right of S. People sit between Q and S. R sits to the immediate right of S and to the immediate left of U. T sits to the immediate left of Q. P is not a neighbour of Q. Who sits second from the extreme left end of the row?

- Ans
- 1. Q
 - 2. V
 - 3. R
 - 4. P

Q.16 In a certain code language, 'BASKET' is written as '64' and 'TANKER' is written as '75'. How will 'VACATION' be written in that language?

- Ans
- 1. 93
 - 2. 102
 - 3. 90
 - 4. 101

Q.17 Six numbers 1, 2, 3, 4, 5 and 6 are written on different faces of a dice. Two positions of this dice are shown in the figure. Find the number on the face opposite to 5.

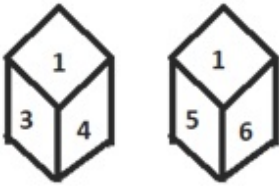

- Ans
- 1. 3
 - 2. 4
 - 3. 6
 - 4. 2

Q.18 Select the figure that will replace the question mark (?) in the following figure series.



- Ans
- 1.
 - 2.
 - 3.
 - 4.

Q.19 The sequence of folding a piece of paper and the manner in which the folded paper is cut is shown in the following figures. How would this paper look when unfolded?

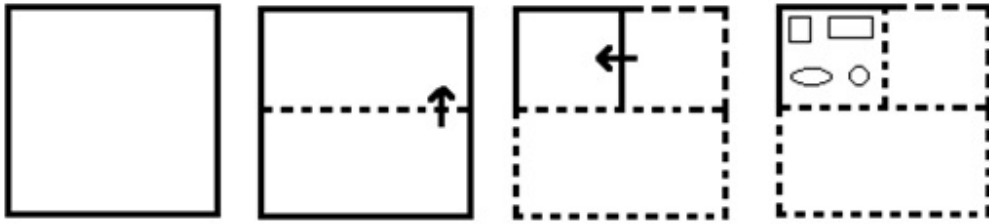

Ans

X 1.

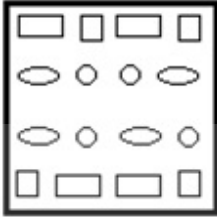

✓ 2.

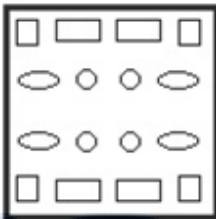

X 3.



X 4.

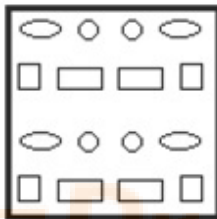

Q.20 The sequence of folding a piece of paper and the manner in which the folded paper has been cut is shown below figure which would most closely resemble the unfolded form of the paper.

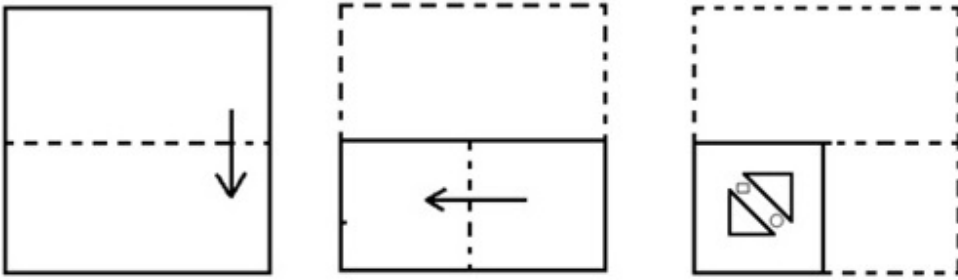

Ans

X 1.

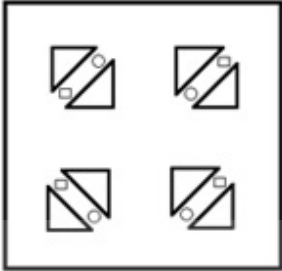

✓ 2.

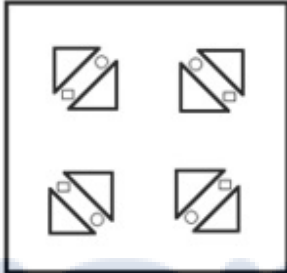

X 3.



X 4.

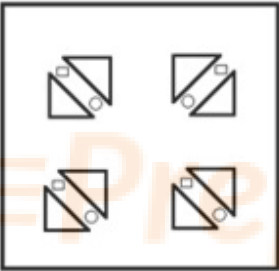

Q.21 Which figure should replace the question mark (?) in the following series to continue the pattern?

L	I	C	△	△	C	I	A	
	△		I		A		C	?
K		C	A	L	L	I	D	△

Ans

1.

C		△
	D	
I		A

2.

A		I
	D	
△		C

3.

△		D
	I	
A		C

4.

△		C
	D	
A		I

Q.22 Which of the following letter clusters will replace the question mark (?) in the given series to make it logically complete?
HLS, KJP, NHM, QFJ, ?

Ans 1. UDG

2. TDF

3. TDG

4. TDH

Prepare 50% Faster

Q.23 Select the figure from the given options that will replace the question mark (?) in the figure given below to complete the pattern so that the final image is symmetrical.

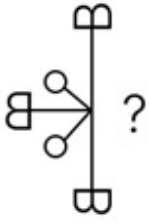

Ans

- 1.
- 2.
- 3.
- 4.

Q.24 Two statements are given, followed by two conclusions numbered I and II. Assuming the statements to be true, even if they seem to be at variance with commonly known facts, decide which of the conclusions logically follow(s) from the statements.

Statements:

All crows are birds.

Some crows are pets.

Conclusions:

I. All pets are birds.

II. Some birds are crows.

Ans

- 1. Both Conclusions I and II follow.
- 2. Only Conclusion I follows.
- 3. Neither Conclusion I nor II follows.
- 4. Only Conclusion II follows.

Q.25 Select the correct combination of mathematical signs that can sequentially replace the * signs and balance the given equation.

$$30 * 6 * 5 * 4 * 2 * 27$$

Ans

- 1. +, ×, −, ÷, =
- 2. +, −, ×, ÷, =
- 3. +, ×, −, =, ÷
- 4. ÷, ×, +, −, =

Section : Numerical Ability

Q.1 The average of 10 terms is 50 and the average of the first 5 terms is 45. What is the average of the remaining 5 terms?

Ans

- 1. 55
- 2. 50
- 3. 45
- 4. 40

Q.2 A person takes a loan of ₹4,000 for 3 years at 8% per annum compound interest. He repaid ₹2,000 in each of the first and second years. The amount he should pay at the end of the third year to clear all his debt is:

Ans

- 1. ₹567.12
- 2. ₹525.34
- 3. ₹500.20
- 4. ₹546.05

Q.3 Bhumika deposited ₹8,000, which amounted to ₹9,200 after 3 years at $r\%$ p.a. simple interest. Had the interest rate more, that is, $(r + 2)\%$ per annum, what amount would she have received?

- Ans
- 1. ₹9,680
 - 2. ₹9,700
 - 3. ₹9,600
 - 4. ₹9,890

Q.4 The monthly incomes of A and B are in the ratio of 3 : 4, and their monthly expenditures are in the ratio 2 : 3. If each saves ₹6,000 per month, then find the monthly income of the B.

- Ans
- 1. ₹24,000
 - 2. ₹22,000
 - 3. ₹25,000
 - 4. ₹23,000

Q.5 A solid metallic hemisphere of radius 9 cm is melted and recast into a right circular cone of height 72 cm. The radius of the base of the cone is:

- Ans
- 1. $8\frac{1}{2}$ cm
 - 2. $3\frac{1}{2}$ cm
 - 3. $5\frac{1}{2}$ cm
 - 4. $4\frac{1}{2}$ cm

Q.6 Radha and Shama undertake a piece of work for ₹36,000. Radha can do it in 20 days and Shama can do it in 60 days. With the help of Rama, they finished it in 10 days. How much should Rama be paid for her contribution?

- Ans
- 1. ₹8,000
 - 2. ₹20,000
 - 3. ₹12,000
 - 4. ₹15,000

Q.7 A man increases his consumption of sugar by 44.44% because the price of sugar is reduced by $P\%$. Find P . (Expenditure remains constant.)

- Ans
- 1. $20\frac{10}{13}\%$
 - 2. $25\frac{10}{13}\%$
 - 3. $30\frac{10}{13}\%$
 - 4. $32\frac{10}{13}\%$

Q.8 Area of the first triangle is 420 cm^2 and its base is 60 cm, whereas, area of the second triangle is 1500 cm^2 and its base is 7.5 cm. What will be the ratio of the height of the first triangle to that of the second triangle?

- Ans
- 1. 6 : 325
 - 2. 7 : 250
 - 3. 5 : 242
 - 4. 7 : 200

Q.9 A cloth merchant sold half of his clothes at 30% profit, half of the remaining clothes at 20% loss, and the rest was cost price. In the total transaction, what is his gain or loss percentage?

- Ans**
- 1. Loss 10%
 - 2. Loss 12%
 - 3. Profit 10%
 - 4. Profit 12%

Q.10 The monthly income of a person is ₹45,000. If his income is increased by 25%, then find his new monthly income (in ₹).

- Ans**
- 1. 55,500
 - 2. 58,250
 - 3. 56,250
 - 4. 11,250

Q.11 A man decides to travel 90 kilometres in 9 hours, partly by foot and partly on a bicycle. If his speed on foot is 9 kilometres/hour and bicycle is 18 kilometres/hour, what is the distance he travels on foot?

- Ans**
- 1. 68 kilometres
 - 2. 100 kilometres
 - 3. 85 kilometres
 - 4. 72 kilometres

Q.12 The product of two numbers is 8427. If the HCF of these numbers is 53, then find the greater number.

- Ans**
- 1. 159
 - 2. 189
 - 3. 119
 - 4. 109

Q.13 For what value of n are $3^n - 2^n$ and $3^n + 2^n$ prime?

- Ans**
- 1. 2
 - 2. 3
 - 3. 4
 - 4. 5

Q.14 The value of $\frac{0.0203 \times 2.92}{0.7 \times 0.0365 \times 2.9}$ is:

- Ans**
- 1. 0.3
 - 2. 0.5
 - 3. 0.8
 - 4. 0.7

Q.15 Three successive discounts of 15%, 10% and 8% are equivalent to a single discount of $k\%$. Find the value of k .

- Ans**
- 1. 27.62%
 - 2. 28.62%
 - 3. 29.62%
 - 4. 30.62%

Q.1 Under which of the following tabs of the MS Word 365 ribbon are the Bullets and Numbering options present?
Ans 1. Home
 2. File
 3. Mailings
 4. Insert

Q.2 Which organisation oversees the development and standardisation of technologies for the World Wide Web?
Ans 1. IEEE
 2. WHO
 3. W3C
 4. IEIT

Q.3 In MS Excel 365, A Contour map is an example of which of the following charts?
Ans 1. Surface Chart
 2. Radar chart
 3. Scatter chart
 4. Doughnut chart

Q.4 In MS Excel 365, the default row height and the column width, respectively, are:
Ans 1. 5 and 10.43
 2. 20 and 10.51
 3. 10 and 8.52
 4. 15 and 8.43

Q.5 Files or documents that are included with the email are commonly referred to as _____.
Ans 1. appends
 2. supplements
 3. add-ons
 4. attachments

Q.6 Which of the following shortcut keys is used in MS Word 365 to move by one preview page when zoomed out?
Ans 1. Ctrl+D
 2. Page UP or Page Down
 3. Ctrl+P
 4. Ctrl+Alt+I

Q.7 In Microsoft Excel 365, what is a function?
Ans 1. A method to create animations in spreadsheets
 2. A predefined formula that performs calculations using values in a specific order
 3. A design tool for creating charts and graphs
 4. A text formatting option for cells

Q.8 Which of the following features can you use if you are having problems or want to find out how to do something in MS Word 365?
Ans 1. Insert
 2. Help
 3. Edit
 4. Review

Q.9 Which of the following is a shortcut key to open the Font dialog box in MS Word 365?

- Ans
- 1. Alt+F
 - 2. Ctrl+F
 - 3. Ctrl+Alt+F
 - 4. Ctrl+Shift+F

Q.10 What is the default page orientation in Microsoft Word 365?

- Ans
- 1. Landscape
 - 2. Portrait
 - 3. Pentagon
 - 4. Square



Prepare 50% Faster

Constable Executive Male and Female in Delhi Police Examination 2023

Exam Date	02/12/2023
Exam Time	3:00 PM - 4:30 PM
Subject	Constable Executive Male and Female in Delhi Police Examination 2023

Section : General Knowledge

Q.1 Ngozi Okonjo-Iweala is currently heading which of the following institutions?

- Ans**
- 1. Asian Development Bank
 - 2. WTO
 - 3. IMF
 - 4. World Bank

Q.2 विजयनगर के सम्राट अच्युत देव राय _____ वंश के थे।

- Ans**
- 1. संगम
 - 2. तुलुव
 - 3. अराविडु
 - 4. सुलुव

Q.3 Match the columns with respect to the ranking of the given countries on the Human Development Index 2021/2022 out of 191 countries.

Country	Rank
1. China	a. 161
2. Nepal	b. 143
3. Pakistan	c. 79

- Ans**
- 1. 1-a, 2-c, 3-b
 - 2. 1-a, 2-b, 3-c
 - 3. 1-c, 2-a, 3-b
 - 4. 1-c, 2-b, 3-a

Q.4 Music composer Debojyoti Mishra has won the Best Music Director award at the 20th Imagine India Film Festival in _____ for his work in film 'Bansuri: The Flute'.

- Ans**
- 1. Germany
 - 2. Italy
 - 3. Spain
 - 4. France

Q.5 When did Italian traveller Marco Polo visit Kerala?

- Ans**
- 1. 13th CE
 - 2. 15th CE
 - 3. 10th CE
 - 4. 8th CE

Q.6 अशोक के शासनकाल के दौरान बलुआ पत्थर के एकात्मक स्तंभों को बौद्ध अवधारणाओं के शिलालेखों के साथ-साथ _____ हाथ जैसे पशु आकृतियों से अभिषिक्त किया गया था।

- Ans
- 1. घोड़े
 - 2. बिल्ली
 - 3. कुत्ते
 - 4. बैल

Q.7 Cell nucleus was discovered by _____.

- Ans
- 1. Robert Brown
 - 2. Rudolf Virchow
 - 3. Matthias Schleiden
 - 4. Robert Hook

Q.8 The famous Hindi novel 'Gaban' is written by:

- Ans
- 1. Mahadevi Verma
 - 2. Amrita Pritam
 - 3. Munshi Premchand
 - 4. Dharmveer Bharati

Q.9 Patanjali is well known for the compilation of:

- Ans
- 1. Bramhasutra
 - 2. Ayurveda
 - 3. Yoga Sutra
 - 4. Panchatantra

Q.10 The Bombay Presidency Association was started by Badruddin Tyabji, Pherozshah Mehta and KT Telang in which of the following years?

- Ans
- 1. 1887
 - 2. 1888
 - 3. 1886
 - 4. 1885

Q.11 निम्नलिखित में से कौन-सा किसी देश की अर्थव्यवस्था के वैश्वीकरण का परिणाम है?

- Ans
- 1. विनिवेश
 - 2. राजकोषीय नीति में सुधार
 - 3. आउटसोर्सिंग
 - 4. मौद्रिक नीति सुधार

Q.12 Where is the headquarters of the National Rifle Association of India situated?

- Ans
- 1. Mumbai
 - 2. Kolkata
 - 3. New Delhi
 - 4. Bengaluru

Q.13 राज्यसभा को भारत के संविधान के अनुच्छेद 312 के तहत कौन सी विशेष शक्ति प्राप्त है?

- Ans
- 1. कुछ लोगों के लिए विशेष अधिकारों का विस्तार करने की
 - 2. सरकार पर प्रतिबंध लगाने की
 - 3. मानवाधिकार आयोग के सदस्यों की नियुक्ति करने की
 - 4. नई अखिल भारतीय सेवा का सृजन करने की

Q.14 _____ एशिया की सबसे बड़ी झुग्गी बस्ती है।

- Ans
- 1. बैंगनवाड़ी
 - 2. बाणगंगा
 - 3. धारावी
 - 4. कठपुतली

Q.15 In which of the following years did India start celebrating National Sports Day?

- Ans
- 1. 2012
 - 2. 2013
 - 3. 2015
 - 4. 2010

Q.16 Who among the following was the founder of Raigarh gharana of Kathak?

- Ans
- 1. Janaki Prasad
 - 2. Shambhu Maharaj
 - 3. Raja Chakradhar Singh
 - 4. Ishwari Prasad

Q.17 प्रसिद्ध रुमटेक मठ निम्नलिखित में से किस राज्य में स्थित है?

- Ans
- 1. उत्तराखंड
 - 2. पश्चिम बंगाल
 - 3. असम
 - 4. सिक्किम

Q.18 The Strait of Gibraltar connects which of the following Ocean with the Mediterranean Sea and separates Spain on the European continent from Morocco on the African continent?

- Ans
- 1. Atlantic Ocean
 - 2. Indian Ocean
 - 3. Southern Ocean
 - 4. Pacific Ocean

Q.19 Part IV-A of the Constitution of India contains _____ Articles.

- Ans
- 1. three
 - 2. two
 - 3. one
 - 4. four

Q.20 मौलिक कर्तव्यों के संबंध में निम्नलिखित में से कौन सा कथन सही है?

- I)सरदार स्वर्ण सिंह ने भारत के संविधान में मौलिक कर्तव्यों पर एक अध्याय शामिल करने की अनुशंसा की।
II)सहकारी समितियों को बढ़ावा देना एक मौलिक कर्तव्य है।

- Ans
- 1. केवल 2
 - 2. 1 और 2 दोनों
 - 3. न तो 1 और न ही 2
 - 4. केवल 1

Q.21 In which of the following Articles of the Constitution of India is it mentioned that "it shall be the duty of every citizen of India to abide by the Constitution and respect its ideals and institutions, the National Flag and the National Anthem"?

- Ans
- 1. 51A (j)
 - 2. 51A (f)
 - 3. 51A (k)
 - 4. 51A (a)

Q.22 Which of the following organisations was founded by Vinayak Damodar Savarkar in 1904?

- Ans
- 1. Abhinav Bharat Society
 - 2. Free India Society
 - 3. Indian Independence League
 - 4. Jugantar

Q.23 Which cargo port in India has the biggest capacity from the followings?

- Ans
- 1. New Mangalore Port
 - 2. Marmagao Port
 - 3. Tuticorin Port
 - 4. Jawaharlal Nehru Port

Q.24 Which of the following ministries is the implementing ministry for 'PM CARES for Children Scheme'?

- Ans
- 1. Ministry of Social Justice and Empowerment
 - 2. Ministry of Home Affairs
 - 3. Ministry of Health and Family Welfare
 - 4. Ministry of Women and Child Development

Q.25 The first National Games post-independence was held at _____.

- Ans
- 1. New Delhi
 - 2. Lucknow
 - 3. Jabalpur
 - 4. Madras

Q.26 If NDP at factor cost = ₹1,050 crore
Subsidies = ₹40 crore
Net factor income from abroad = ₹10 crore
How much is NNP at factor cost?

- Ans
- 1. ₹1,090 crore
 - 2. ₹1,100 crore
 - 3. ₹1,040 crore
 - 4. ₹1,060 crore

Q.27 At which of the following places did Gandhiji conduct his first experiment of Satyagraha in India?

- Ans
- 1. Calcutta
 - 2. Ahmedabad
 - 3. Cawnpore
 - 4. Champaran

Q.28 In which of the following years was the National Human Rights Commission formed?

- Ans
- 1. 1993
 - 2. 1965
 - 3. 2000
 - 4. 1980

Q.29 चित्रकोट जलप्रपात भारत के नियाग्रा जलप्रपात के रूप में जाना जाने वाला एक प्राकृतिक जलप्रपात है, जो भारत के छत्तीसगढ़ राज्य में _____ नदी पर स्थित है।

- Ans
- 1. मांडवी नदी
 - 2. इंद्रावती नदी
 - 3. वराही नदी
 - 4. चंद्रवंका नदी

Q.30 नीचे दिए गए कथनों पर विचार कीजिए और भारतीय लोक और जनजातीय नृत्य शैलियों के संबंध में सही विकल्प का चयन कीजिए।
i) चैलम (Chailam), मिजोरम का लोक नृत्य है।
ii) होजागिरी, गुजरात का लोक नृत्य है।
iii) बिदेसिया, बिहार का लोक नृत्य है।

- Ans
- 1. (i) और (iii), दोनों सही हैं।
 - 2. केवल (i) सही है।
 - 3. केवल (ii) सही है।
 - 4. (ii) और (iii), दोनों सही हैं।

Q.31 The Constitution of India provides for a _____ integrated judicial system.

- Ans
- 1. multi-level
 - 2. three-level
 - 3. single-level
 - 4. dual-level

Q.32 Who among the following used the term Evergreen Revolution for increasing agricultural production in India?

- Ans
- 1. MS Swaminathan
 - 2. RKV Rao
 - 3. Norman Borlaug
 - 4. Raj Krishna

Q.33 Who among the following Mohiniyattam dancer who has written the book 'Mohiniyattam: Charithravum Aattaprakaravum' has received the prestigious Kalidas Samman in 1997?

- Ans
- 1. Rukmini Devi Arundale
 - 2. Kalamandalam Kalyanikutty Amma
 - 3. Yamini Krishnamurthy
 - 4. Shovana Narayan

Q.34 National Sports University is situated in _____.

- Ans
- 1. Itanagar
 - 2. Imphal
 - 3. Chennai
 - 4. New Delhi

Q.35 Identify the correct statement in the context of five-year plans in India.
(i) In the first five-year plan, the top priority was given to agriculture.
(ii) In the second five-year plan, the top priority was given to industry.

- Ans
- 1. Neither (i) nor (ii)
 - 2. Only (i)
 - 3. Both (i) and (ii)
 - 4. Only (ii)

Q.36 Padma Vibhushan awardee Kathak dancer and choreographer, Birju Maharaj belonged to which of the following Gharanas?

- Ans
- 1. Benaras
 - 2. Kalka - Bindadin
 - 3. Gwalior
 - 4. Jaipur

Q.37 Which of the following is an NBFC-MFI that operates in a joint liability group lending model of Grameen?

- Ans
- 1. Arohan Financial Services Limited
 - 2. Bandhan Financial Services Private Limited
 - 3. Equitas Small Finance Bank
 - 4. Fusion Microfinance Private Limited

Q.38 Mahatma Gandhi started the Dandi March in 1930 from _____.

- Ans
- 1. Yerawada Ashram
 - 2. Dandi Ashram
 - 3. Surat Ashram
 - 4. Sabarmati Ashram

Q.39 Which of the following is an example of a joint sector industry?

- Ans
- 1. National Highway Authority of India
 - 2. Oil India Limited
 - 3. Hindustan Aeronautics Limited
 - 4. Steel Authority of India Limited

Q.40 Phytoplanktons are _____.

- Ans
- 1. tertiary consumers of pond ecosystem
 - 2. secondary consumers of ocean ecosystem
 - 3. primary consumers of lake ecosystem
 - 4. producers in pond ecosystem

Q.41 Lalitha and Saroja Chidambaram are the noted _____ singers.

- Ans
- 1. folk
 - 2. Carnatic
 - 3. Hindustani classical
 - 4. Sufi

Q.42 Which of the following statements is correct about ecological succession?

Statement 1: It is the gradual and fairly predictable change in the species composition of a given area.
Statement 2: It is the method of ecology conservation.

- Ans
- 1. Both Statements 1 and 2 are incorrect
 - 2. Only Statement 1 correct
 - 3. Only Statement 2 correct
 - 4. Both Statements 1 and 2 are correct

Q.43 Which of the following dynasties was ruling Magadha immediately before Chandragupta Maurya established Murayan Empire in Ancient India?

- Ans
- 1. Pradyota
 - 2. Shaishunaga
 - 3. Brihadratha
 - 4. Nanda

Q.44 Chandrayaan-3 leaves Earth's surface by burning a huge amount of fuel. The gases released then push the rocket upwards against gravity. Which law of motion is applied here?

- Ans
- 1. Newton's 3rd law of motion
 - 2. Newton's 2nd law of motion
 - 3. Newton's 1st law of motion
 - 4. Newton's law of gravitation

Q.45 निम्नलिखित में से कौन-सा अनुच्छेद राज्य के पोषण-स्तर और जीवन-स्तर को बढ़ाने और सार्वजनिक स्वास्थ्य में सुधार करने के कर्तव्य करता है?

- Ans
- 1. अनुच्छेद 44
 - 2. अनुच्छेद 46
 - 3. अनुच्छेद 45
 - 4. अनुच्छेद 47

Q.46 Baliyatra is the cultural festival of which Indian state?

- Ans
- 1. West Bengal
 - 2. Odisha
 - 3. Jharkhand
 - 4. Kerala

Q.47 Who was the author of 'The Great Indian Novel'?

- Ans
- 1. Shashi Tharoor
 - 2. Anuj Dhar
 - 3. Anees Salim
 - 4. Salim Khan

Q.48 The Multidimensional Poverty Index of India does NOT consider which of the following for calculating the index?

- Ans
- 1. Standard of Living
 - 2. Health
 - 3. Education
 - 4. Environmental quality

Q.49 In which state is the Gandhi Sagar Wildlife Sanctuary located?

- Ans
- 1. Assam
 - 2. Nagaland
 - 3. Madhya Pradesh
 - 4. Karnataka

Q.50 Showcasing its wildlife and religious sites at the 74th parade, which of the following states' tableau won 1st prize at the 2023 Republic Day?

- Ans
- 1. Gujarat
 - 2. Uttarakhand
 - 3. Arunachal Pradesh
 - 4. Jharkhand

Section : Reasoning

Q.1 Seven girls - H, J, K, L, M, N and O - are sitting in a straight row, facing north. Only four girls sit between O and N. Only O sits to the right of L. H sits exactly between J and K. Who among the following sits at the extreme left end of the row?

- Ans
- 1. K
 - 2. J
 - 3. M
 - 4. N

Q.2 Select the figure from the options that can replace the question mark (?) and complete the given pattern.

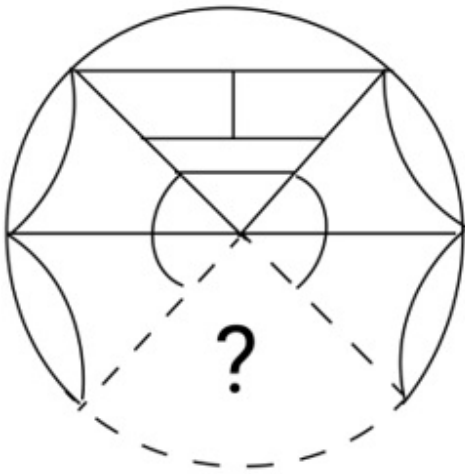

Ans

✗ 1.

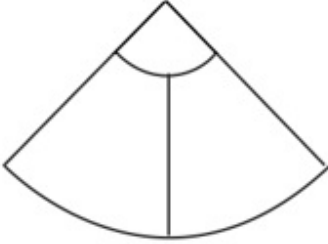

✗ 2.

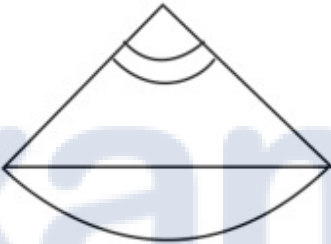

✗ 3.

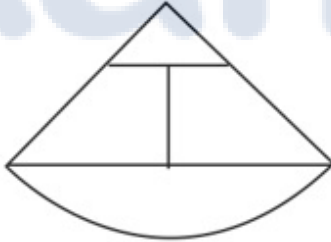

✓ 4.

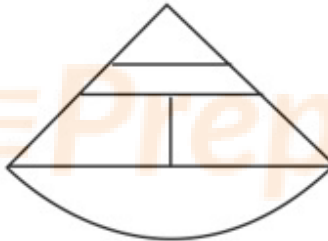

Q.3 Four different positions of the same dice are shown below. What is opposite to 3?

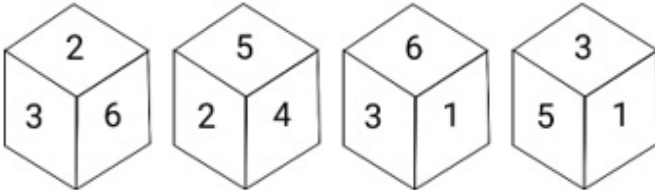

Ans ✗ 1. 1

✗ 2. 6

✗ 3. 2

✓ 4. 4

Q.4 Which figure should replace the question mark (?) in the following series to continue the pattern?

R	S	O	E	
O ▽ E	E R O S	R ▽ ▽	O S	?
S	▽	E	R	

Ans

✓ 1.

S
E O R
▽

✗ 2.

S
R O E
▽

✗ 3.

R
S ▽ O
E

✗ 4.

▽
R O E
S

Q.5 If 'A' denotes '+', 'B' denotes 'x', 'C' denotes '-' and 'D' denotes '÷', then what will come in place of '?' in the following equation?
(98 C 8) B 2 A 16 = ?

Ans ✗ 1. 16

✗ 2. 98

✓ 3. 196

✗ 4. 104

Q.6 Which two signs should be interchanged to make the following equation correct?

$$2 \times 4 \div 5 - 25 + 5 = 8$$

Ans ✗ 1. - and x

✓ 2. ÷ and +

✗ 3. - and +

✗ 4. ÷ and x

Q.7 Select the number from among the given options that can replace the question mark (?) in the following series.

56, 97, 179, 343, 671, ?

- Ans
- 1. 4232
 - 2. 1327
 - 3. 3231
 - 4. 3442

Q.8 Two statements are given followed by two conclusions numbered I and II. Assuming the statements to be true, even if they seem to be at variance from commonly known facts, decide which of the conclusions logically follow(s) from the statements.

Statements:

Some Fishes are Cats.

All Cats are Soft.

Conclusions:

I. All Soft are Cats.

II. Some Fishes are Soft.

- Ans
- 1. Only conclusion I follows.
 - 2. Neither conclusion I nor II follows.
 - 3. Both conclusions I and II follow.
 - 4. Only conclusion II follows.



Prepare 50% Faster

Q.9 Which of the figures given in the options is embedded in the following figure?
(Rotation is not allowed.)

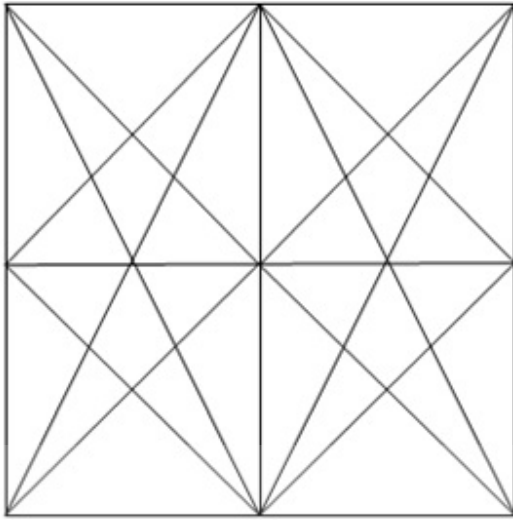

Ans

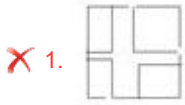

Q.13 Select the option figure which is embedded in the given figure as its part (rotation is NOT allowed).



Ans

- 1.
- 2.
- 3.
- 4.

Q.14 Select the correct mirror image of the given figure when the mirror is placed at MN as shown below.

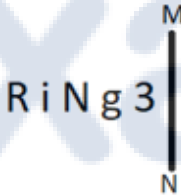

Ans

- 1. g3ИiЯ
- 2. εg RiN
- 3. εgИ!Я
- 4. εgИiЯ

Q.15 Select the correct mirror image of the given figure when the mirror is placed at PQ as shown below.



Ans



Q.16 Select the correct mirror image of the given combination when the mirror is placed at 'MN' as shown below.

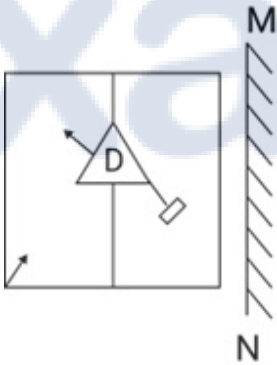

Ans

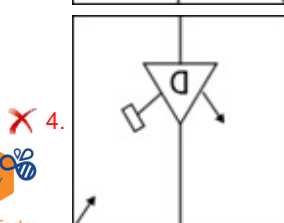
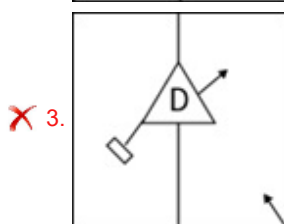
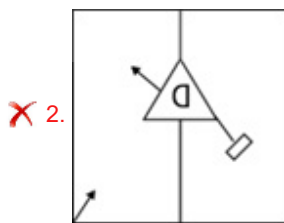
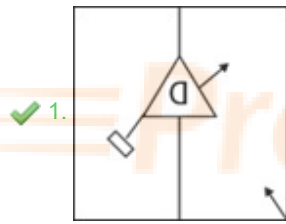

Q.17 Select the figure from the options that can replace the question mark (?) and complete the given pattern.

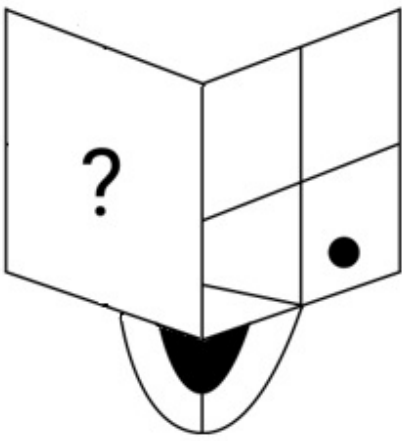

Ans

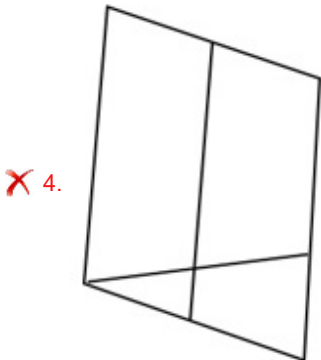
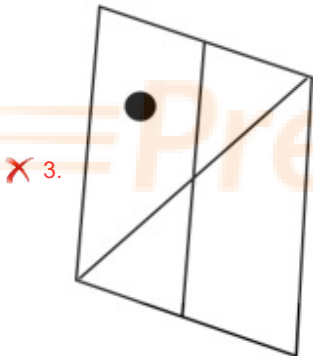
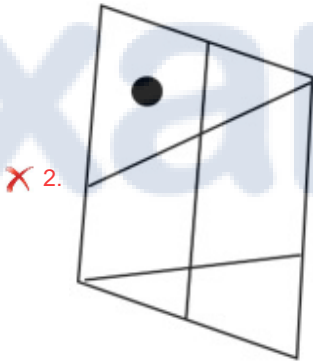
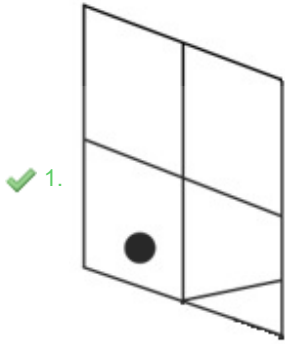

Q.18 Following question consists of 4 figures marked 1, 2, 3 and 4 called the Problem Figures followed by 4 other figures called the Answer Figures. Select a figure from amongst the Answer Figures which will continue the same series as established by the four Problem Figures.

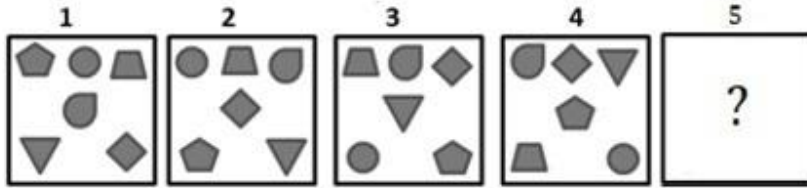

Ans

- 1.
- 2.
- 3.
- 4.

Q.19 In a certain code language, 'SUGAR' is written as 'VHBST' and 'TEAPOT' is written as 'FBQPUU'. How will 'PAINT' be written in that language?

- 1. QBJOU
- 2. UOJBQ
- 3. BJOQU
- 4. BJOUQ

Q.20 Select the option figure that is embedded in the given figure (rotation is NOT allowed).

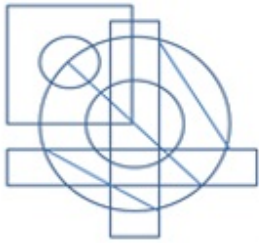

Ans



Q.21 Select the set in which the numbers are related in the same way as are the numbers of the following sets. (NOTE : Operations should be performed on the whole numbers, without breaking down the numbers into its constituent digits. E.g. 13 – Operations on 13 such as adding /deleting /multiplying etc. to 13 can be performed. Breaking down 13 into 1 and 3 and then performing mathematical operations on 1 and 3 is NOT allowed)
(12, 44), (17, 64)

- Ans
- ✗ 1. (31, 124)
 - ✗ 2. (27, 94)
 - ✗ 3. (18, 74)
 - ✓ 4. (22, 84)

Q.22 Observe the dots on a dice (one to six dots) in the following figures. How many dots are contained on the face opposite to that containing two dots?

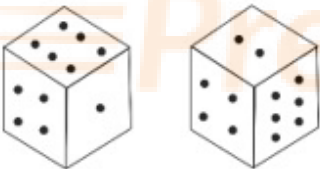

- Ans
- ✗ 1. Five
 - ✗ 2. Three
 - ✗ 3. Six
 - ✓ 4. One

Q.23 Which figure should replace the question mark (?) if the following series were to be continued?

0	9	W	=	0	A	A	=	0	9	A	△	△	9	A	
A	U	=	W	9	U	△	W	9	0	=	W	U	0	=	?
2	☆	△	△	2	☆	2	☆	U	U	2	☆	2	☆	W	

Ans

✓ 1.

=	△	U
A	9	0
W	2	☆

✗ 2.

W	△	9
A	U	0
=	2	☆

✗ 3.

U	△	9
0	=	A
W	2	☆

✗ 4.

A	△	9
=	U	0
W	2	☆

Q.24 Select the option that is related to the third term in the same way as the second term is related to the first term and the sixth term is related to the fifth term.
34 : 170 :: 68 : ? :: 17 : 85

- Ans
- ✗ 1. 360
 - ✗ 2. 300
 - ✓ 3. 340
 - ✗ 4. 320

Q.25 Select the option that is related to the fifth letter-cluster in the same way as the second letter-cluster is related to the first letter-cluster and the fourth letter-cluster is related to the third letter-cluster.
NEVER : PGXGT :: BELOW : DGNQY :: AGAIN : _____

- Ans
- ✗ 1. DJDLQ
 - ✗ 2. BHBJO
 - ✓ 3. CICKP
 - ✗ 4. ZFZHM

Section : Numerical Ability

Q.1 The population of a village 4 years ago was 3,20,000. Due to migration to cities, it decreases at the rate of 5% every year. Find the decrease in its population in the last 4 years.

- Ans
- ✗ 1. 83,595
 - ✗ 2. 53,985
 - ✓ 3. 59,358
 - ✗ 4. 93,558

Q.2 A thief was noticed by a policeman from a distance of 300 m. Seeing the policeman, the thief started running at 10 km/h. The policeman chased him at 13 km/h. What is the distance between them after 12 minutes?

- Ans
- 1. 90 m
 - 2. 120 m
 - 3. 105 m
 - 4. 100 m

Q.3 The price of CNG is increased by 12%. By what percentage (correct up to two decimal places) must Shalini reduce consumption of CNG for her car so that there is no increment in her expenditure on CNG?

- Ans
- 1. 13.64%
 - 2. 12.00%
 - 3. 10.71%
 - 4. 9.33%

Q.4 Raju sold a watch to Sanjeev at a 20% gain; Sanjeev sold it to Mukesh at a loss of 10%. If Mukesh bought it for ₹4,860, then at what price did Raju purchase it?

- Ans
- 1. ₹4,400
 - 2. ₹4,500
 - 3. ₹4,450
 - 4. ₹4,550

Q.5 Ram and Shyam together can complete a work in 12 days. Shyam alone can complete the work in 15 days. Shyam alone worked for 5 days. After that, how long will Ram alone take to complete the work?

- Ans
- 1. 40 days
 - 2. 29 days
 - 3. 38 days
 - 4. 35 days

Q.6 What is the value of $4 \times 0.4 \times 0.04 \times 0.004 \times 40$?

- Ans
- 1. 0.1024
 - 2. 0.01024
 - 3. 0.00256
 - 4. 0.0256

Q.7 A student's marks (out of 100 in each subject) changed from the first term exams to the second term exams as follows: in Mathematics from 60 to 78, in Science 84 to 82, in Social studies 76 to 64. What is the percentage change in his marks from the first term exams to the second term exams?

- Ans
- 1. 1.81% increase
 - 2. 2.24% increase
 - 3. 2.24% decrease
 - 4. 1.81% decrease

Q.8 The ratio of a Aman's age to Shivam's age is 4 : 3. The product of their ages is 588. The ratio of their ages after 5 years will be:

- Ans
- 1. 31 : 25
 - 2. 33 : 24
 - 3. 33 : 26
 - 4. 35 : 26

Q.9 Which of the following numbers is a prime number?

- Ans
- 1. 143
 - 2. 141
 - 3. 133
 - 4. 137

Q.10 A pillar 42 cm in diameter is 15 m high. How much material (in cm^3) was used to construct it?

(Take $\pi = \frac{22}{7}$)

- Ans
- 1. 2.079×10^{-3}
 - 2. 2.079×10^5
 - 3. 2.079×10^{-4}
 - 4. 2.079×10^6

Q.11 A sum becomes two times in 4 years at a certain rate of simple interest. Find the time (in years) in which the same amount will be seven times at the same rate of interest.

- Ans
- 1. 20
 - 2. 24
 - 3. 12
 - 4. 13

Q.12 Simplify the following.

$$\frac{0.4 \times 0.4 + 0.2 \times 0.02}{0.016}$$

- Ans
- 1. $10\frac{1}{4}$
 - 2. $10\frac{1}{8}$
 - 3. $10\frac{1}{5}$
 - 4. $10\frac{1}{2}$

Q.13 A shopkeeper marks up the price of an article by 60%. He offers two successive discounts of 10% and 15% on it. He earns X% profit. What is the value of X?

- Ans
- 1. 20.4
 - 2. 22.4
 - 3. 23.60
 - 4. 25.60

Q.14 How many litres of water can a hemispherical bowl of radius 3 cm hold?
(Use $\pi = 3.14$)

- Ans
- 1. 56.52
 - 2. 54.34
 - 3. 0.05652
 - 4. 0.05275

- Q.15** The average of 7 consecutive integers is 7. What is the value of the greatest number in these?
- Ans**
- 1. 11
 - 2. 10
 - 3. 9
 - 4. 12

Section : Computer Proficiency

Q.1 What is the default alignment for text entered in Microsoft Excel 365 cells?

- Ans**
- 1. Right aligned
 - 2. Center aligned
 - 3. Left aligned
 - 4. Justified

Q.2 What is the keyboard shortcut for changing text alignment to the left in MS Word 365?

- Ans**
- 1. Ctrl + L
 - 2. Ctrl + R
 - 3. Ctrl + C
 - 4. Ctrl + J

Q.3 Which of the following is NOT a word processing package?

- Ans**
- 1. Apple Pages
 - 2. Google Docs
 - 3. Adobe Photoshop
 - 4. Microsoft Word

Q.4 F1 is the shortcut key used by almost every Windows program to display which of the following menus?

- Ans**
- 1. Rename
 - 2. Edit
 - 3. Refresh
 - 4. Help

Q.5 Which of the following is NOT an example of Instant Messaging in Internet?

- Ans**
- 1. Email
 - 2. WhatsApp
 - 3. Telegram
 - 4. Discord

Q.6 What is the purpose of spellcheck in email composition?

- Ans**
- 1. To format the email text
 - 2. To check for and correct spelling errors
 - 3. To add attachments to the email
 - 4. To translate the email into another language

Q.7 In MS Excel 365, how can you set a specific print area in MS Excel?

- Ans**
- 1. By adjusting the page margins in the print settings
 - 2. By changing the font size and style in the spreadsheet
 - 3. By applying conditional formatting to the data
 - 4. By selecting the cells to be printed and defining the print area

Q.8 In MS word 365, in word-processing software, what is the key difference between copying of text and cutting of text?

- Ans**
- 1. Copying requires the use of a keyboard shortcut, while cutting is performed by using the mouse.
 - 2. Copying is reversible, while cutting is irreversible.
 - 3. Copying removes the text from the original location, while cutting retains the text in the original location.
 - 4. Copying duplicates the text to a new location, while cutting moves the text to a new location.

Q.9 Which of the following is the correct software used for Word processing?

- Ans**
- 1. MS Access
 - 2. MS PowerPoint
 - 3. MS Excel
 - 4. MS Word

Q.10 If the custom format of a number is XX,XX,XXX then how will 4482023 be displayed in Microsoft Excel 365?

- Ans**
- 1. 44,82,023
 - 2. 448,20,23
 - 3. 4,48,2023
 - 4. 4482, 02,3

ixamBee

Prepare 50% Faster

Constable Executive Male and Female in Delhi Police Examination 2023

Exam Date	03/12/2023
Exam Time	9:00 AM - 10:30 AM
Subject	Constable Executive Male and Female in Delhi Police Examination 2023

Section : General Knowledge

Q.1 What was the major approach of the Second Five-Year Plan towards industrialisation?

- Ans**
- 1. Expansion of the cottage industry so as to create employment opportunities in the rural areas
 - 2. Expansion of the public sector so as to create a base of heavy industry
 - 3. Focus on infrastructure so as to create employment opportunities in the urban areas
 - 4. Focus on mass consumption goods so as to control inflation

Q.2 Avani Lekhara is associated with which of the following sports?

- Ans**
- 1. Para-badminton
 - 2. Para-athletics
 - 3. Paralympic shooting
 - 4. Freestyle wrestling

Q.3 which of the following materials were pillars in Stupas built during Ashoka's reign?

- Ans**
- 1. Marble
 - 2. Stone
 - 3. Granite
 - 4. Bricks

Q.4 Which of the following type of biome have the subtype called as 'Tropical Savannah'?

- Ans**
- 1. aquatic
 - 2. desert
 - 3. grassland
 - 4. forest

Q.5 Who among the following was the Chief Guest in the Republic Day Parade organised at Rajpath in the year 1955?

- Ans**
- 1. Nelson Mandela
 - 2. General Malik Ghulam Muhammad
 - 3. Abdel Fatah-al-Sisi
 - 4. Queen Elizabeth II

Q.6 In which Olympics did Abhinav Bindra win the gold medal in Men's 10 m air rifle shooting?

- Ans**
- 1. Beijing 2008
 - 2. London 2012
 - 3. Rio 2016
 - 4. Athens 2004

Q.7 The Hindustan Republican Association was reorganised into Hindustan Socialist Republican Association (HSRA) at Shah Kotla Ground in Delhi on 8th and 9th September _____.

- Ans
- 1. 1927
 - 2. 1929
 - 3. 1928
 - 4. 1930

Q.8 Which of the following classical dances is associated with Saint Srimanta Sankardev?

- Ans
- 1. Sattriya
 - 2. Kathakali
 - 3. Odissi
 - 4. Mohiniyattam

Q.9 From which of the following countries were the principles of liberty, equality and fraternity taken in the Indian Constitution?

- Ans
- 1. United Kingdom
 - 2. Ireland
 - 3. United States of America
 - 4. France

Q.10 In which Five-Year Plan was the family planning programme undertaken?

- Ans
- 1. 2nd Five-Year Plan
 - 2. 7th Five-Year Plan
 - 3. 4th Five-Year Plan
 - 4. 5th Five-Year Plan

Q.11 By which Constitutional Amendment Act can the same person be appointed as the Governor of two or more states?

- Ans
- 1. 9th Constitutional Amendment Act
 - 2. 18th Constitutional Amendment Act
 - 3. 11th Constitutional Amendment Act
 - 4. 7th Constitutional Amendment Act

Q.12 In which state is the Kundang Lem Festival celebrated?

- Ans
- 1. Nagaland
 - 2. Punjab
 - 3. Kerala
 - 4. Madhya Pradesh

Q.13 In a pond ecosystem, the first trophic level includes _____.

- Ans
- 1. zooplankton
 - 2. grasshopper
 - 3. phytoplankton
 - 4. cow

Q.14 According to the Census of India 2011, which is the second most literate state in India?

- Ans
- 1. Tripura
 - 2. Karnataka
 - 3. Mizoram
 - 4. Odisha

Q.15 Dark patches on the sun are referred to as:

- Ans
- 1. earth spots
 - 2. moon spots
 - 3. dark spots
 - 4. sun spots

Q.16 The phenomenon of change of liquid into vapours at any temperature below its boiling point is called:

- Ans
- 1. Fusion
 - 2. Sublimation
 - 3. Evaporation
 - 4. Melting

Q.17 The Fundamental Rights can be suspended during the operation of a National Emergency except the rights guaranteed by _____.

- Ans
- 1. Articles 18 and 19
 - 2. Articles 14 and 15
 - 3. Articles 20 and 21
 - 4. Article 23 and 24

Q.18 The collegium system of appointment of Judges to the High Court and Supreme Court came into existence by virtue of _____.

- Ans
- 1. an act of Parliament
 - 2. a result of three separate cases before the Supreme Court
 - 3. a Constitutional Amendment
 - 4. a decision by the Cabinet Committee

Q.19 Gopika Verma, the famous _____ dancer received various awards, including the Sangeet Natak Akademi Award in 2018.

- Ans
- 1. Bharatanatyam
 - 2. Odissi
 - 3. Mohiniattam
 - 4. Sattriya

Q.20 Conservation of biological diversity and sustainable use of its components are the main objectives of which of the following treaties/protocols?

- Ans
- 1. Nagoya protocol
 - 2. Rio protocol
 - 3. Montreal protocol
 - 4. Geneva protocol

Q.21 'Unbreakable' is an autobiography of an Indian Boxer _____ and co-authored by Dina Serto.

- Ans
- 1. Lovlina Borgohain
 - 2. Vijender Singh
 - 3. Laishram Sarita Devi
 - 4. Mary Kom

Q.22 In 8th century India, Nagabhata I established which of the following Rajput dynasties in Malwa region?

- Ans
- 1. Gurjara-Pratihara
 - 2. Tomara
 - 3. Parmara
 - 4. Chauhan

Q.23 Which of the following is NOT an Indian multinational company?

- Ans
- 1. Asian Paints Limited
 - 2. General Motors Company
 - 3. Tata Consultancy Services Limited
 - 4. Arvind Mills Limited

Q.24 Which of the following is/are NOT a part of the financial sector?

- Ans
- 1. Department of Agriculture & Farmers Welfare
 - 2. Commercial banks
 - 3. Stock exchange operations
 - 4. Investment banks

Q.25 As per Census of India 2011, identify the state in which the population density was recorded more than 100 people / sq.km.

- Ans
- 1. Sikkim
 - 2. Arunachal Pradesh
 - 3. Rajasthan
 - 4. Mizoram

Q.26 Which of the following statements about GDP is correct?
 (i) GDP is used for measuring human development.
 (ii) Externalities are not captured while estimating GDP.
 (iii) Services provided by housewives are included while estimating GDP.

- Ans
- 1. Only III
 - 2. Only II
 - 3. Only I and II
 - 4. Only I

Q.27 The federal scheme, Judiciary and Governors system of the Constitution of India are drawn from the _____.

- Ans
- 1. Government of India Act of 1942
 - 2. Government of India Act, 1935
 - 3. Government of India Act of 1945
 - 4. Government of India Act, 1919

Q.28 The terms Mahari and Gotipua are associated with which Indian classical dance form?

- Ans
- 1. Manipuri
 - 2. Kuchipudi
 - 3. Odissi
 - 4. Sattriya

Q.29 The last ruler of the Mauryan Empire was:

- Ans
- 1. Dasharatha Maurya
 - 2. Samprati
 - 3. Brihadratha
 - 4. Shalishuka

Q.30 The HPCL Rajasthan Refinery Ltd (HRRL) is being constructed in which district (as of December 2022)?

- Ans
- 1. Bikaner
 - 2. Jaisalmer
 - 3. Jalore
 - 4. Barmer

Q.31 The Anglo-Mysore Wars were a series of _____ wars fought during the 18th century between the rulers of Mysore and the English East India Company.

- Ans
- 1. three
 - 2. six
 - 3. two
 - 4. four

Q.32 Sitara Devi was a _____ dancer of India.

- Ans
- 1. Bharatanatyam
 - 2. Kuchipudi
 - 3. Kathak
 - 4. Kathakali

Q.33 Which of the following players is associated with para-badminton?

- Ans
- 1. Manish Narwal
 - 2. Sumit Antil
 - 3. Avani Lekhara
 - 4. Krishna Nagar

Q.34 In which of the following years was the Election Commission of India established?

- Ans
- 1. 1954
 - 2. 1957
 - 3. 1960
 - 4. 1950

Q.35 Which of the following rivers is known as Dakshin Ganga?

- Ans
- 1. Godavari
 - 2. Tapi
 - 3. Narmada
 - 4. Kaveri

Q.36 Who among the following was the son of Ustad Allauddin Khan?

- Ans
- 1. Aamir Khan
 - 2. Amjad Ali Khan
 - 3. Ali Akbar Khan
 - 4. Jakir Husain

Q.37 Which state is the leading producer of Jowar as of 2022?

- Ans
- 1. Andhra Pradesh
 - 2. Uttar Pradesh
 - 3. Odisha
 - 4. Maharashtra

Q.38 Harmika is one of the features of _____ in Buddhist architecture.

- Ans
- 1. viharas
 - 2. pillars
 - 3. stupas
 - 4. chaityas

Q.39 'Wings of Fire' is an autobiography of which of the following personalities?

- Ans
- 1. K Sivan
 - 2. Pranab Mukherjee
 - 3. APJ Abdul Kalam
 - 4. Inder Kumar Gujral

Q.40 In which of the following years was the Child Marriage Restraint Act passed in India?

- Ans
- 1. 1947
 - 2. 1936
 - 3. 1929
 - 4. 1951

Q.41 A follower of Gokhale, Narayan Malhar Joshi founded the Social Service League in Bombay, in which of the following years?

- Ans
- 1. 1912
 - 2. 1914
 - 3. 1913
 - 4. 1911

Q.42 _____ is related to hockey.

- Ans
- 1. Davis Cup
 - 2. Ranji Trophy
 - 3. Thomas Cup
 - 4. Aga Khan Cup

Q.43 Who among the following is the exponent of mandolin?

- Ans
- 1. Annapurna Devi
 - 2. U Srinivas
 - 3. N Rajam
 - 4. N Ramani

Q.44 Which Satavahana king restored the Satavahana realm to its earlier greatness around 125 CE?

- Ans
- 1. Mihira Bhoja
 - 2. Gautamiputra
 - 3. Krishna III
 - 4. Rajaraja I

Q.45 The government budget is prepared under which article of the Constitution of India?

- Ans
- 1. Article 109
 - 2. Article 112
 - 3. Article 100
 - 4. Article 101

Q.46 Which of the following is the first national park that was established in India?

- Ans
- 1. Jim Corbett National Park
 - 2. Kaziranga National Park
 - 3. Gir National Park
 - 4. Rajaji National Park

Q.47 Who among the following gave the famous words, 'One Caste, One Religion, One God for all men'?

- Ans
- 1. Sri Narayana Guru
 - 2. Jyotirao Phule
 - 3. Swami Vivekananda
 - 4. Raja Ram Mohan Roy

Q.48 The Make in India Scheme of the Government is administered under the _____ .

- Ans
- 1. Ministry of Electronics & Information Technology
 - 2. Ministry of Finance
 - 3. Ministry of Commerce & Industry
 - 4. Ministry of External Affairs

Q.49 Which Ministry is responsible for collecting data and publishing literacy rates in India?

- Ans
- 1. Ministry of External Affairs
 - 2. Ministry of Rural Development
 - 3. Ministry of Statistics and Programme Implementation
 - 4. Ministry of Education

Q.50 Which of the following Articles are related to Right Against Exploitation?

- Ans
- 1. Article 23-24
 - 2. Article 25-26
 - 3. Article 28-29
 - 4. Article 31-32

Section : Reasoning

Q.1 Select the correct combination of mathematical signs to replace the * signs and to balance the given equation.
 $264 * 4 * 7 * 87 * 370 * 5$

- Ans
- 1. $\div \times = + -$
 - 2. $\div \times - + =$
 - 3. $\div \times - = +$
 - 4. $\times - = + \div$

Q.2 Select the set in which the numbers are related in the same way as do the numbers of the following sets.
 (NOTE: Operations should be performed on the whole numbers, without breaking down the numbers into their constituent digits. E.g. 13 – Operations on 13 such as adding/subtracting/multiplying etc. to 13 can be performed. Breaking down 13 into 1 and 3 and then performing mathematical operations on 1 and 3 is not allowed.)

(58, 34, 72)
 (46, 28, 54)

- Ans
- 1. (62, 34, 84)
 - 2. (56, 32, 68)
 - 3. (48, 26, 56)
 - 4. (52, 24, 94)

Q.3 Seven people - A, B, C, D, X, Y and Z - are sitting in a straight row, facing north. Only two people sit to the left of D. B sits second to the left of Z. Y sits third to the left of A. Only one person sits to the right of X. Who among the following sits at the second position from the left?

- Ans
- 1. C
 - 2. A
 - 3. Y
 - 4. B

Q.4 Select the figure that will come next in the following figure series.

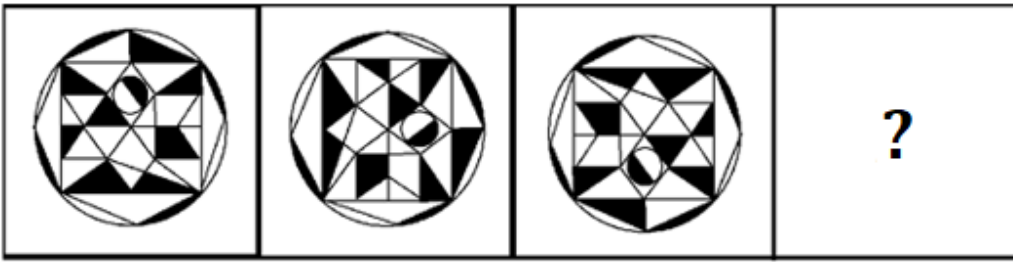

Ans

✗ 1.



✗ 2.



✓ 3.



✗ 4.



Q.5 In a code language, if PIGEON is coded as 11-18-20-22-12-13 and NEST is coded as 13-22-8-7, then how will WOODPECKER be coded?

Ans ✗ 1. 5-13-13-24-12-23-25-17-23-10

✗ 2. 3-11-11-22-10-21-23-15-21-8

✓ 3. 4-12-12-23-11-22-24-16-22-9

✗ 4. 4-11-11-23-11-21-24-15-21-9

Q.6 Given below is a series of figures – A, B, C and D which follow a particular pattern. Which of the given option figure come in place of E to continue the series?

Ω	+	∇	B	△	∩	+	□	
∇	△	△	+	+	B	B	∩	?

(A) (B) (C) (D) (E)

Ans

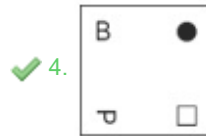
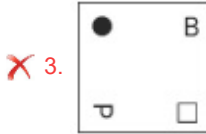
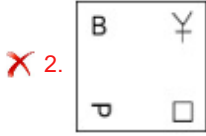
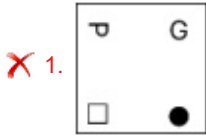

Q.7 Select the option in which the given figure is embedded (rotation is NOT allowed).



Ans

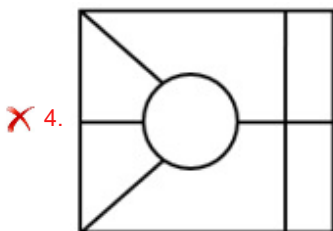
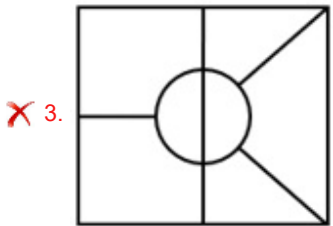
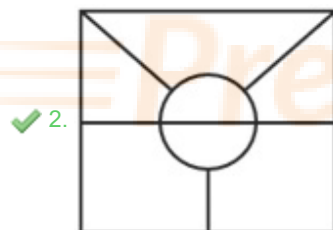
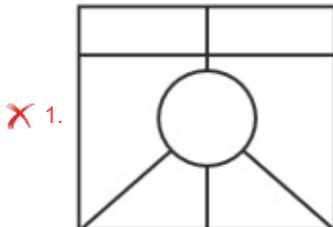

Q.8 Select the option that is related to the third word in the same way as the second word is related to the first word. (The words must be considered as meaningful English words and must not be related to each other based on the letters/number of consonants/vowels in the word)

Linen : Flax :: Road : ?

- Ans
- ✓ 1. Asphalt
 - ✗ 2. Ore
 - ✗ 3. Brass
 - ✗ 4. Copper

Q.9 A paper is folded and cut as shown below. How will it appear when unfolded?

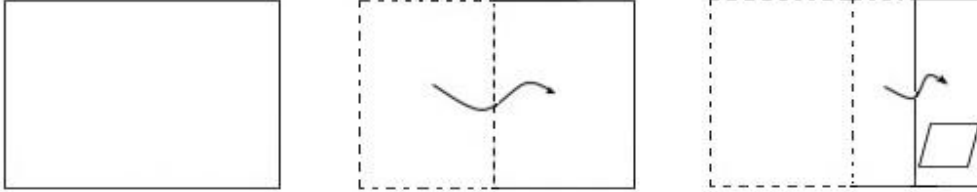

Ans

- ✗ 1.
- ✗ 2.
- ✗ 3.
- ✓ 4.

Q.10 Six letters, K, L, M, N, O and P are written on different faces of a dice. Three positions of this dice are shown here. Find the letter on the face opposite K.

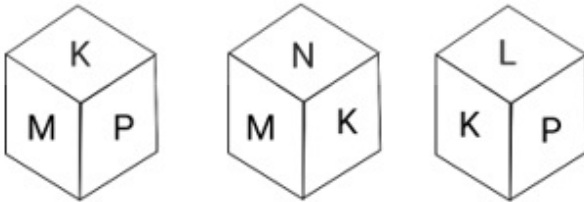

- Ans
- ✗ 1. N
 - ✗ 2. L
 - ✗ 3. M
 - ✓ 4. O

Q.11 Read the given statements and conclusions carefully. Assuming that the information given in the statements is true and it appears to be at variance with commonly known facts, decide which of the given conclusions logically follow(s) from the statements.

Statements:

Some blankets are quilts.

Some quilts are bedsheets.

Conclusions:

I. All bedsheets are blankets.

II. Some bedsheets are blankets.

- Ans
- 1. Both conclusions I and II follow
 - 2. Only conclusion I follows
 - 3. Neither conclusion I nor II follows
 - 4. Only conclusion II follows

Q.12 Select the option that is embedded in the given figure (rotation is NOT allowed).

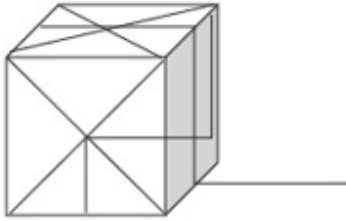

Ans

1.



2.



3.

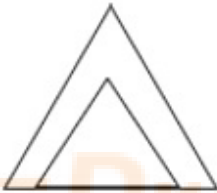

4.



Q.13 Select the correct mirror image of the given figure when the mirror is placed at MN as shown in  Prepare 50% Faster

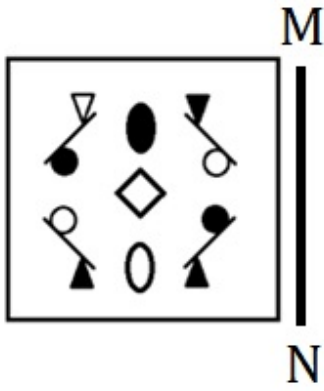

Ans

✓ 1.

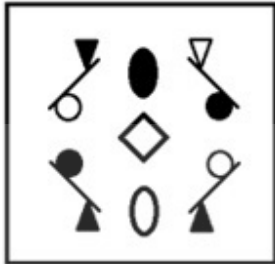

✗ 2.

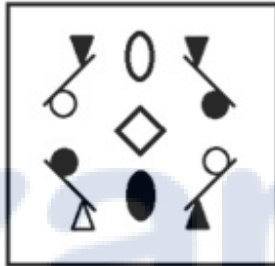

✗ 3.



✗ 4.

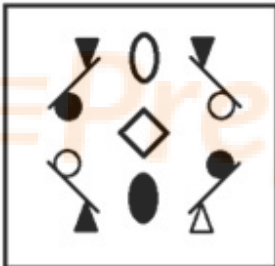

Q.14 A paper is folded and cut as shown below. How will it appear when unfolded?

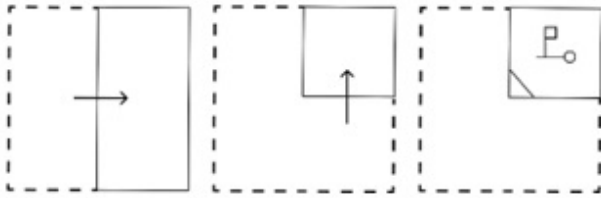

Ans

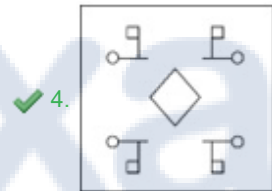
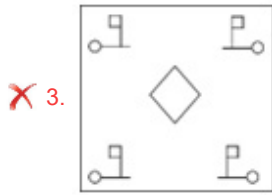
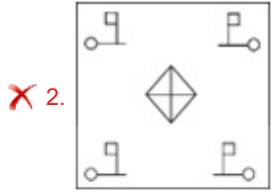
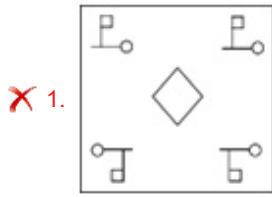

Q.15 Six letters P, Q, R, S, T and U are written on different faces of a dice. Three different positions of this dice are shown in the figure. Select the letter that will be on the face opposite to the one having Q.

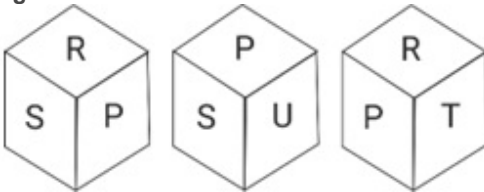

- Ans
- ✗ 1. U
 - ✗ 2. R
 - ✗ 3. T
 - ✓ 4. P

Prepare 50% Faster

Q.16 Select the figure from the options that can replace the question mark (?) and complete the given pattern.

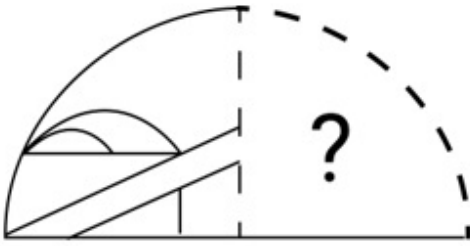

Ans

✓ 1.

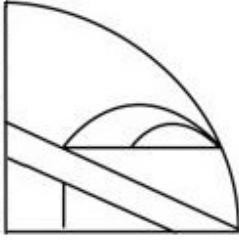

✗ 2.

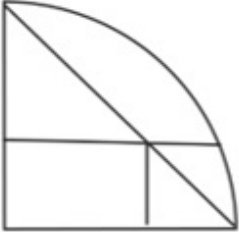

✗ 3.

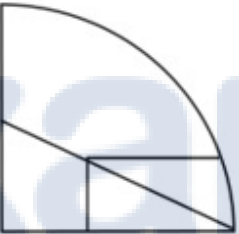

✗ 4.

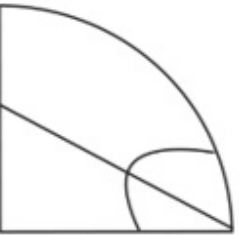

Q.17 Select the correct combination of mathematical signs to sequentially replace the * signs and to balance the given equation.
 $23 * 2 * 10 * 20 * 5 = 40$

Ans ✗ 1. + × - ÷

✗ 2. + - × ÷

✓ 3. × - + ÷

✗ 4. - + ÷ ×

Q.18 Which of the following terms will replace the question mark (?) in the given series?

JASX, LWUT, NSWP, POYL, ?

Ans ✓ 1. RKAH

✗ 2. SJAH

✗ 3. SKBF

✗ 4. RJBG

Q.19 8 is related to 67 following a certain logic. Following the same logic, 4 is related to 19. To which of the following is 4 related to 19 following the same logic?

- Ans
- 1. 28
 - 2. 39
 - 3. 31
 - 4. 32

Q.20 Select the option in which the given figure is embedded. (Rotation is NOT allowed.)



Ans

1.

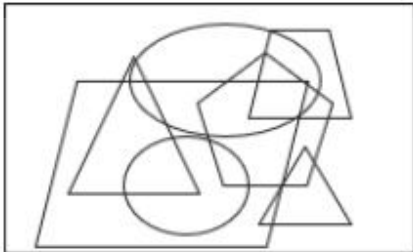

2.

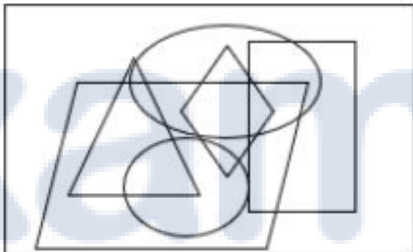

3.

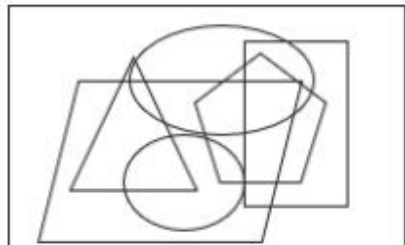

4.

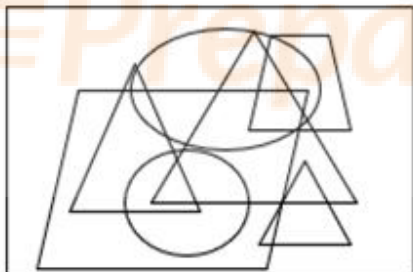

Q.21 How many triangles are there in the given figure?

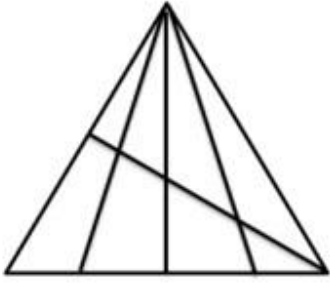

- Ans
- 1. 23
 - 2. 25
 - 3. 24
 - 4. 18

Q.22 Select the correct mirror image of the given figure when the mirror is placed at MN as shown below.

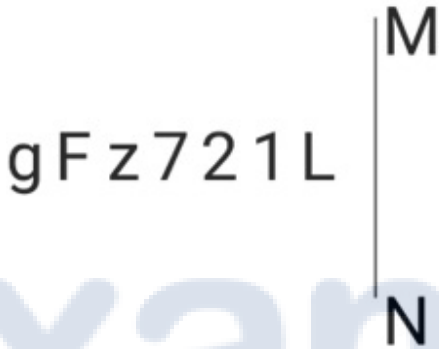

- Ans
- 1. J 1 2 7 5 7 g
 - 2. J 1 5 7 5 7 g
 - 3. J 1 2 7 5 7 g
 - 4. J 1 5 7 5 7 g

Prepare 50% Faster

Q.23 Select the option in which the given figure is embedded (rotation is NOT allowed).



Ans

X 1.

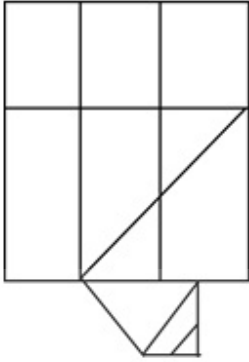

✓ 2.

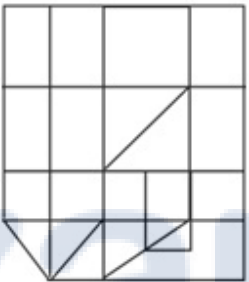

X 3.

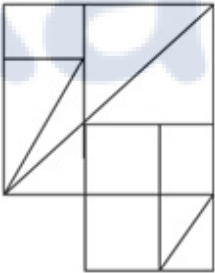

X 4.

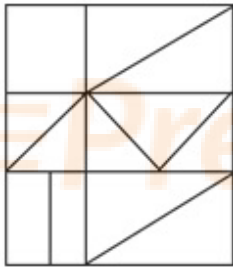

Q.24 Select the figure that will replace the question mark (?) in the following figure series.

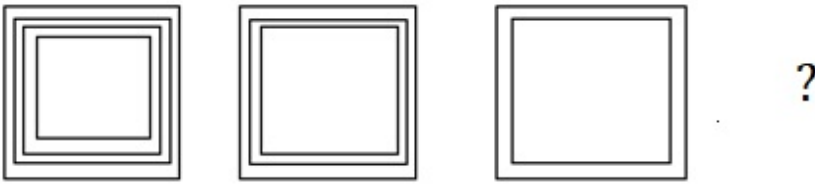

Ans

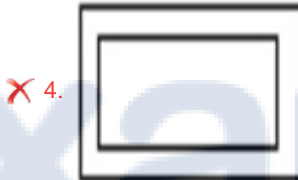
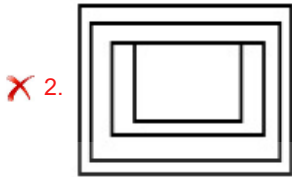
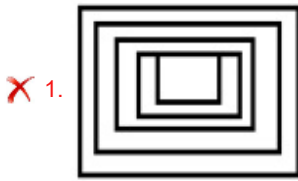

Q.25 Select the number from among the given options that can replace the question mark (?) in the following series.

5, 21, 69, 213, 645, ?

- Ans
- ✓ 1. 1941
 - ✗ 2. 323
 - ✗ 3. 6343
 - ✗ 4. 3224

Section : Numerical Ability

Q.1 For a cylinder with a radius of 3 units and height of 8 units, what is the length of the largest straight rod that can be put inside it?

- Ans
- ✗ 1. 9
 - ✓ 2. 10
 - ✗ 3. 12
 - ✗ 4. 11

Q.2 The radius of a giant metal spherical ball is 12 cm. Its outer surface is required to be painted. What will be the cost of the painting at the rate of ₹7 per cm^2 . (Approximate to the nearest integer) (Take $\pi = \frac{22}{7}$)

- Ans
- ✗ 1. ₹13,168
 - ✗ 2. ₹11,664
 - ✗ 3. ₹10,684
 - ✓ 4. ₹12,672

Q.3 An electric bike is available for Rs.1 lakh. A customer has to pay Rs.20,800 down payment, followed by 4 equal in If the rate of interest charged is 25% per annum simple interest, calculate the 4 yearly installments.

- Ans**
- 1. Rs.28,800
 - 2. Rs.21,210
 - 3. Rs.22,110
 - 4. Rs.21,120

Q.4 Rohan's monthly salary is increased from ₹40,000 to ₹45,000. What is the percentage increment in his monthly salary?

- Ans**
- 1. 12.5%
 - 2. 12%
 - 3. 10.5%
 - 4. 11%

Q.5 A boy goes to his school from his house at a speed of 5 km/h and returns at a speed of 10 km/h, then the average speed of the boy is:

- Ans**
- 1. $6\frac{2}{3}$ km/h
 - 2. $3\frac{2}{3}$ km/h
 - 3. $4\frac{1}{3}$ km/h
 - 4. $3\frac{1}{3}$ km/h

Q.6 If the ratio of A and B is 4 : 3 and the ratio of B and C is 7 : 2, what is the ratio of A, B and C?

- Ans**
- 1. 21 : 28 : 6
 - 2. 8 : 21 : 14
 - 3. 28 : 6 : 8
 - 4. 28 : 21 : 6

Q.7 The sum of the smallest three-digit prime number and the largest three-digit prime number is:

- Ans**
- 1. 1104
 - 2. 1098
 - 3. 1100
 - 4. 1093

Q.8 The HCF of 408 and 1309 is:

- Ans**
- 1. 17
 - 2. 21
 - 3. 19
 - 4. 15

Q.9 The income of a person first increased by 10% and then it is decreased by 10%. What is the change in his income?

- Ans**
- 1. 2% (decrease)
 - 2. 5% (decrease)
 - 3. 1% (decrease)
 - 4. 2% (increase)

Q.10 What is the rate of compound interest if a sum becomes $\frac{1331}{729}$ times of itself in 3 years?

- Ans
- 1. $22\frac{2}{9}\%$
 - 2. $33\frac{1}{9}\%$
 - 3. $21\frac{7}{9}\%$
 - 4. $11\frac{7}{9}\%$

Q.11 Ayush buys an old digital camera for ₹9,200 and spends ₹1,200 on its repair. If Ayush sells the digital camera for ₹12,000, what is his profit percentage (correct up to two decimal places)?

- Ans
- 1. 17.39%
 - 2. 13.58%
 - 3. 15.38%
 - 4. 19.73%

Q.12 Prakash can do a piece of work in 18 days. If Mukesh works twice as fast as Prakash, how long would it take to finish the work, working together?

- Ans
- 1. 6 days
 - 2. 5 days
 - 3. 4 days
 - 4. 7 days

Q.13 The concentration of three acids, P, Q and R, is given as 15%, 25% and 35%, respectively. They are mixed in the ratio of x : 3 : 5, resulting in a 28% concentration solution. What is the value of x?

- Ans
- 1. 2
 - 2. 1
 - 3. 4
 - 4. 3

Q.14 The tag price of an item is ₹250. After a discount of x% of tag price, the shopkeeper earns 1.25x% profit. What is the cost of the item if x=10?

- Ans
- 1. ₹200
 - 2. ₹220
 - 3. ₹190
 - 4. ₹210

Q.15 The LCM of 98, 145 and 505 is:

- Ans
- 1. 1636120
 - 2. 1435210
 - 3. 1852010
 - 4. 1715201

Q.1 Which is the following methods is used in unguided transmission media?

- Ans**
- 1. Infrared
 - 2. Twisted pair cable
 - 3. Coaxial cable
 - 4. Optical fibre cable

Q.2 In MS Word 365, which of the following is the default font style and size in the Font style and size dropdown list when a new document is opened in Windows 10?

- Ans**
- 1. Calibri, 11
 - 2. Times New Roman, 11
 - 3. Aharoni, 11
 - 4. Arial, 11

Q.3 In MS Excel 365 how can you quickly delete a row in Excel without using the context menu or ribbon options?

- Ans**
- 1. Select the row and press the Delete key.
 - 2. Select the row and press Ctrl and the - (minus) key.
 - 3. Select the row and press Shift+Delete.
 - 4. Select the row and press Alt+Delete.

Q.4 Which option in Microsoft Word 365 allows you to search for a specific word or phrase in the document and replace it with another?

- Ans**
- 1. Cut and Paste
 - 2. Font Formatting
 - 3. Find and Replace
 - 4. Spelling & Grammar

Q.5 What does the 'Search' or 'Find' allow you to do in MS Word 365?

- Ans**
- 1. Print the current document
 - 2. Open a new document
 - 3. Change the document's font
 - 4. Locate specific words or topics in the Help content

Q.6 Which of the following charts is used in MS Excel 365 to display data as a series of points connected by straight lines and is used for showing trends over time?

- Ans**
- 1. Line chart
 - 2. Bar chart
 - 3. Pie chart
 - 4. Column chart

Q.7 In MS-Word 365, which option allows you to manually review and correct spelling and grammar errors in your document by providing suggestions and explanations for each flagged item?

- Ans**
- 1. Word Count
 - 2. Thesaurus
 - 3. AutoCorrect
 - 4. Spelling and Grammar Check

Q.8 Which option allows you to create a table in MS-Word 365?

- Ans**
- 1. Table Layout
 - 2. Table Insertion
 - 3. Table Design
 - 4. Table Creation

Q.9 In Microsoft Excel 365, which keyboard shortcut is used to copy the selected text or cells for pasting them to a new worksheet within the same worksheet?

- Ans**
- 1. Ctrl + V
 - 2. Ctrl + D
 - 3. Ctrl + X
 - 4. Ctrl + C

Q.10 If an email is sent to more than one person, the email addresses are separated by which of the following symbols?

- Ans**
- 1. Equal
 - 2. Paper clip icon
 - 3. Comma
 - 4. At the rate of



Prepare 50% Faster

Constable Executive Male and Female in Delhi Police Examination 2023

Exam Date	03/12/2023
Exam Time	12:00 PM - 1:30 PM
Subject	Constable Executive Male and Female in Delhi Police Examination 2023

Section : General Knowledge

Q.1 Match list I to list II.

List I	List II
a) Nationalisation of 14 banks	i) 1982
b) Dr Manmohan Singh appointed the governor of RBI	ii) 1978
c) Demonetisation of ₹10,000 bank notes	iii) 1969

- Ans
- 1. a-ii, b-i, c-iii
 - 2. a-i, b-ii, c-iii
 - 3. a-iii, b-i, c-ii
 - 4. a-i, b-iii, c-ii

Q.2 In which of the following states is the 'Jhora' dance performed as a springtime celebration?

- Ans
- 1. Uttarakhand
 - 2. Tripura
 - 3. Karnataka
 - 4. Maharashtra

Q.3 Which of the following novels of Shashi Tharoor is a satirical verse on the epic Mahabharata?

- Ans
- 1. Why I Am A Hindu
 - 2. The Hindu Way: An Introduction to Hinduism
 - 3. Tharoorosaurus
 - 4. The Great Indian Novel

Q.4 Which of the following Articles of the Indian Constitution is related with providing a living wage, conditions of work ensuring a decent standard of life and full enjoyment of leisure and social and cultural opportunities by the state?

- Ans
- 1. Article 44
 - 2. Article 45
 - 3. Article 42
 - 4. Article 43

Q.5 The famous 'Sriharikota' island of India is well known as _____.

- Ans
- 1. an IIM center
 - 2. a famous hill station
 - 3. a Space centre
 - 4. the largest island in India

Q.6 Who was the founder of the Maitraka dynasty of Vallabhi?

- Ans
- 1. Bhatarka
 - 2. Yashodharman
 - 3. Baladitya
 - 4. Ishan Varma

Q.7 The seventh five year plan was for which of the following time periods?

- Ans
- 1. 1992-1997
 - 2. 1985-1990
 - 3. 1978-1983
 - 4. 1980-1985

Q.8 The first National Games known as the Indian Olympic Games were hosted before independence in the year _____ .

- Ans
- 1. 1926
 - 2. 1924
 - 3. 1930
 - 4. 1928

Q.9 In the year 2022, a kho-kho league was started with the name:

- Ans
- 1. Diamond Kho-Kho League
 - 2. Ultimate Kho-Kho League
 - 3. Pro Kho-Kho League
 - 4. Reliance Kho-Kho League

Q.10 Identify the word that means the minimum distance at which objects can be seen most distinctly without strain.

- Ans
- 1. Most distance of distant vision
 - 2. Least distance of distinct vision
 - 3. Focal length
 - 4. Least distant of distance vision

Q.11 Water Reservoir, dams and embankments were spotted at which Harappan site?

- Ans
- 1. Surkotada
 - 2. Dholavira
 - 3. Mehrgarh
 - 4. Ropar

Q.12 According to the census of India 2011, the lowest female literacy rate was recorded in the state of _____ .

- Ans
- 1. Bihar
 - 2. West Bengal
 - 3. Chhattisgarh
 - 4. Maharashtra

Q.13 Which of the following is primarily NOT a Sikh festival?

- Ans
- 1. Hola Mohalla
 - 2. Lohri
 - 3. Gyana Panchami
 - 4. Baisakhi

Q.14 When was Arya Samaj founded?

- Ans
- 1. 1828
 - 2. 1875
 - 3. 1867
 - 4. 1893

Q.15 Which economic systems generally give preference to planning to make economic policies?

- Ans
- 1. Both capitalist and socialist economies
 - 2. Mixed and capitalist economies
 - 3. Both socialist and mixed economies
 - 4. Capitalist economies only

Q.16 'What Happened to Netaji' was written by whom among the following?

- Ans
- 1. Kiran Desai
 - 2. Anuj Dhar
 - 3. Arvind Adiga
 - 4. Vikram Seth

Q.17 Which river is bounded by Tungabhadra sub-basin of Krishna basin in the northern side and Palar sub-basin in the southern side?

- Ans
- 1. Tapi Basin
 - 2. Brahmani Basin
 - 3. Cauvery Basin
 - 4. Mahanadi Basin

Q.18 Which of the following statements are correct regarding Fundamental Duties?

- A. They serve as a warning against anti-national and anti-social activities.
- B. They serve as source of inspiration for the citizens and promote a sense of discipline and commitment among them.
- C. There is no legal sanction against the violation of fundamental duties.

- Ans
- 1. A, B and C
 - 2. B and C only
 - 3. A and C only
 - 4. A and B only

Q.19 From their mother's side, Mughal rulers were the descendants of _____.

- Ans
- 1. Mahmud Ghazni
 - 2. Timur
 - 3. Genghis Khan
 - 4. Iltutmish

Q.20 The climate of India is referred to as:

- Ans
- 1. Monsoon
 - 2. Alpine Climate
 - 3. Tundra Climate
 - 4. Arctic Climate

Q.21 Jhijhiya, a famous folk dance performed by women during Navratri, is a popular festival in which of the following states?

- Ans
- 1. Uttar Pradesh
 - 2. Gujarat
 - 3. Rajasthan
 - 4. Bihar

Q.22 Which of the following can be used as a source of energy, when glucose is NOT available in the body?

- Ans**
- 1. Fatty acid
 - 2. Amino acids
 - 3. Lactic acid
 - 4. Carbonic acids

Q.23 Who among the following is a famous veena player?

- Ans**
- 1. Gopal Das
 - 2. Sultan Khan
 - 3. V. Dhannamal
 - 4. N. Rajam

Q.24 In the Indian Constitution, the Concept of Concurrent list was borrowed from the Constitution of _____.

- Ans**
- 1. Portugal
 - 2. Australia
 - 3. Spain
 - 4. Japan

Q.25 According to the Census of India 2011, which Union Territory of India recorded the lowest population?

- Ans**
- 1. Dadra and Nagar Haveli
 - 2. Daman and Diu
 - 3. Puducherry
 - 4. Lakshadweep

Q.26 What is the slogan or tagline of the 'Swachh Bharat Mission' celebrated every year on 2 October?

- Ans**
- 1. Ek Kadam Safai Ki Ore
 - 2. Ek Kadam Swachhata Ki Ore
 - 3. Ek Kadam Sundarta Ki Ore
 - 4. Ek Kadam Paryavaran Ki Ore

Q.27 The proclamation of Constitutional Emergency must be approved by both the houses of parliament within _____ from the date of its issue.

- Ans**
- 1. 3 months
 - 2. 2 months
 - 3. 12 months
 - 4. 6 months

Q.28 Who among the following Bollywood singers received the Padma Shri in 2022?

- Ans**
- 1. Sonu Nigam
 - 2. Shankar Mahadevan
 - 3. Arijit Singh
 - 4. AR Rahman

Q.29 Which method is also known as the 'Income Disposable Method'?

- Ans**
- 1. Product method
 - 2. Income method
 - 3. Divisible method
 - 4. Expenditure method

Q.30 What is the trend of the biological wealth of our planet?

- Ans**
- 1. Cyclical
 - 2. Decreasing
 - 3. Constant
 - 4. Increasing

Q.31 Which of the following dance forms originated in Kuchelapuri or Kuchelapuram, in the 3rd century BC in South India?

- Ans**
- 1. Odissi
 - 2. Kathakali
 - 3. Bharatnatyam
 - 4. Kuchipudi

Q.32 What is the average sea level pressure, according to meteorologists?

- Ans**
- 1. 1000 mb
 - 2. 870 mb
 - 3. 1013 mb
 - 4. 1030 mb

Q.33 The LPG model of development was introduced in 1991 by the then Finance Minister _____.

- Ans**
- 1. Pranab Mukherjee
 - 2. PV Narasimha Rao
 - 3. P Chidambaram
 - 4. Dr Manmohan Singh

Q.34 Which of the following countries was the host of the first Asian games in 1951?

- Ans**
- 1. Japan
 - 2. China
 - 3. Saudi Arabia
 - 4. India

Q.35 Article 50 of the Constitution of India mentions about _____.

- Ans**
- 1. securing the right to adequate means of livelihood
 - 2. separation of Judiciary from Executive in public services
 - 3. promoting equal justice and providing free legal aid
 - 4. promotion of international peace and security

Q.36 In which of the following years did the Swadeshi movement take place to oppose the partition of Bengal?

- Ans**
- 1. 1909
 - 2. 1905
 - 3. 1907
 - 4. 1910

Q.37 A standing committee is a committee consisting of members of which of the following houses of Parliament?

1. Rajya Sabha
2. Lok Sabha
3. Vidhan Sabha

- Ans**
- 1. Both Rajya Sabha and Lok Sabha
 - 2. Vidhan Sabha
 - 3. Rajya Sabha
 - 4. Lok Sabha

Q.38 As per the Regulating Act of 1773, where was the first Supreme Court as a Court of Record established in India?

- Ans
- 1. Madras
 - 2. Bombay
 - 3. Delhi
 - 4. Calcutta

Q.39 Kirti Kisan Party (KKP) was established on _____ at Amritsar.

- Ans
- 1. 12th April 1927
 - 2. 7th February 1927
 - 3. 10th May 1927
 - 4. 13th March 1927

Q.40 In ancient and medieval India, the form of worship often associated with the goddess, in which practitioners often ignored differences of caste and class within the ritual context, was known as:

- Ans
- 1. Puranic
 - 2. Shaivism
 - 3. Mantric
 - 4. Tantric

Q.41 Vikram Era starts from which of the following years?

- Ans
- 1. 68 BC
 - 2. 78 BC
 - 3. 78 AD
 - 4. 57 BC

Q.42 A football match cannot be started if either team consists of fewer than _____ players.

- Ans
- 1. 9
 - 2. 7
 - 3. 10
 - 4. 6

Q.43 For how many vaccine-preventable diseases are immunizations provided under the Universal Immunization Programme?

- Ans
- 1. 15
 - 2. 9
 - 3. 12
 - 4. 11

Q.44 Darbhanga Airport is located in which state of India?

- Ans
- 1. Bihar
 - 2. West Bengal
 - 3. Karnataka
 - 4. Uttar Pradesh

Q.45 Which of the following groups contains only abiotic elements of an ecosystem?

- Ans
- 1. Soil, grasses, flowers, and honeybees
 - 2. Soil, minerals, grass, and flowers
 - 3. Rainfall, grass, insects, and frogs
 - 4. Soil, minerals, wind, and rainfall

Q.46 निम्नलिखित में से कौन-सा विकल्प, मंदिर वास्तुकला के संदर्भ में शब्द 'फमसाना' का सबसे अच्छा वर्णन करता है?

- Ans
- 1. गर्भगृह और मंडप के बीच की दूरी
 - 2. मंदिर का शीर्ष, जहां ध्वज (झंडा) स्थित होता है
 - 3. मंदिर के शीर्ष पर सपाट वृत्ताकार शिलापट्ट की एक संरचना
 - 4. मंदिर की छतें जो कई शिलापट्टों (slabs) से बनी होती हैं

Q.47 Which of the following ministries was responsible for governing 'Indira Awaas Yojana'?

- Ans
- 1. Ministry of Rural Development
 - 2. Ministry of Human Resource Development
 - 3. Ministry of Labour and Employment
 - 4. Ministry of Social Justice and Empowerment

Q.48 Which form of dance is Padma Subrahmanyam well known for?

- Ans
- 1. Mohiniyattam
 - 2. Kathakali
 - 3. Kuchipudi
 - 4. Bharatnatyam

Q.49 For the year 2011-12, the poverty line for a person was fixed at _____ per month for the rural areas.

- Ans
- 1. ₹850
 - 2. ₹915
 - 3. ₹970
 - 4. ₹816

Q.50 The Ryotwari (Peasant) System of 1820 was implemented in which of the following regions?

- Ans
- 1. Rajasthan and Delhi
 - 2. Bengal and Bombay
 - 3. Madras and Punjab
 - 4. Madras and Bombay

Section : Reasoning

Prepare 50% Faster

Q.1 Which figure should replace the question mark (?) if the series were to be continued?

S	I	C	K	K	B	I	S	T	K	B	I	I	C	K	T	?
B		3	3				C	C			3	3			B	

Ans

✗ 1. T I C K
B 3

✗ 2. C K T 9
B 3

✓ 3. 9 I C K
B 3

✗ 4. 3 K C I
B T

Q.2 Select the correct mirror image of the given figure when the mirror is placed at MN as shown below.



Ans

✗ 1. V L 9 i q

✓ 2. A 7 9 i q

✗ 3. A 7 9 ! q

✗ 4. A 7 9 ! P

Q.3 A square sheet of paper is folded along the dotted line successively along the directions shown and is then punched last. How would the paper look when unfolded?

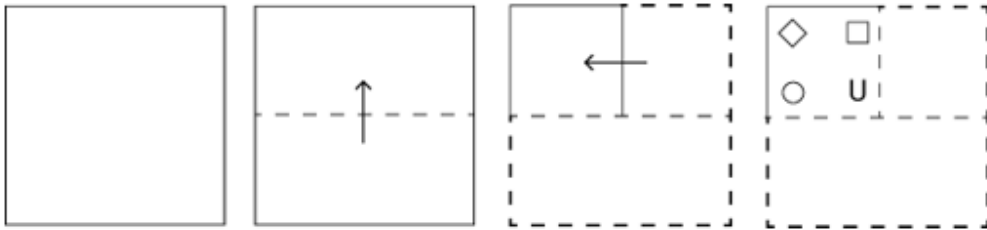

Ans

✓ 1.

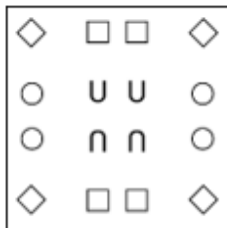

✗ 2.

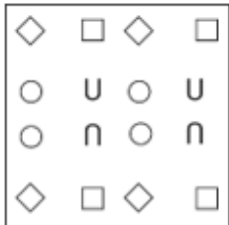

✗ 3.

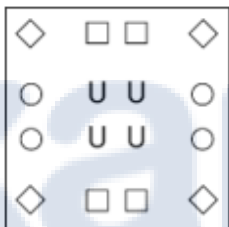

✗ 4.

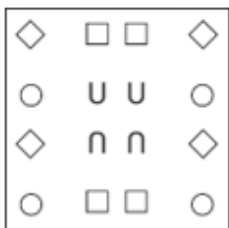

Q.4 Select the option that is related to the third word in the same way as the second word is related to the first word. (The words must be considered as meaningful English words and must not be related to each other based on the number of letters / number of consonants / vowels in the word)
Players : Team :: Artists : ?

Ans

✗ 1. Gang

✗ 2. Horde

✓ 3. Troupe

✗ 4. Mob

Q.5 A square sheet of paper is folded along the dotted line successively along the directions shown and is then punched last. How would the paper look when unfolded?

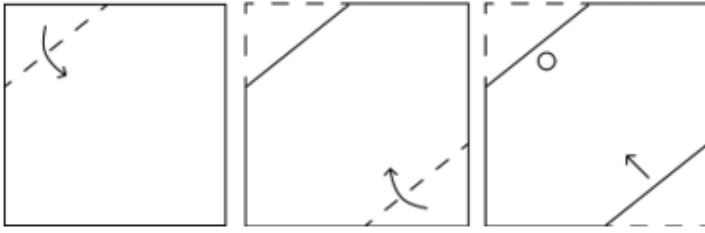

Ans

✓ 1.

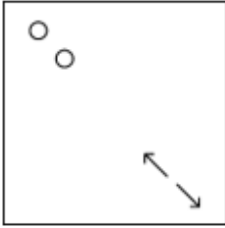

✗ 2.

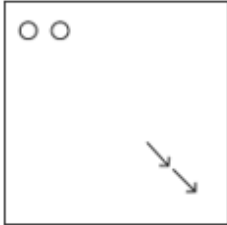

✗ 3.

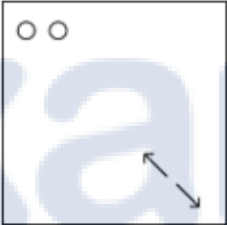

✗ 4.

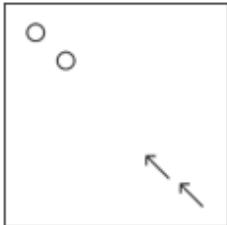

Q.6 A paper is folded and cut as shown below. How will it appear when unfolded?

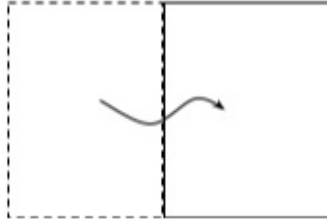

Ans

✗ 1.

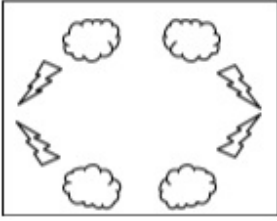

✓ 2.

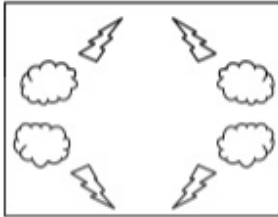

✗ 3.

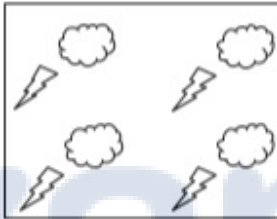

✗ 4.

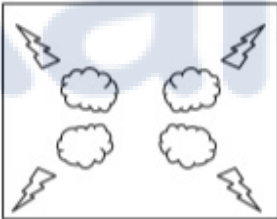

Q.7 Read the given statements and conclusions carefully. Assuming that the information given in the statements is true, even if it appears to be at variance with commonly known facts, decide which of the given conclusions logically follow(s) from the statements.

Statements:

Some rats are bats.

Some bats are cats.

Conclusions:

I. All cats are rats.

II. Some bats are rats.

Ans ✓ 1. Only conclusion II follows

✗ 2. Both conclusions I and II follow

✗ 3. Only conclusion I follows

✗ 4. Neither conclusion I nor II follows

Q.8 Select the figure from the given options that will replace the question mark (?) in the figure given below to complete the pattern.

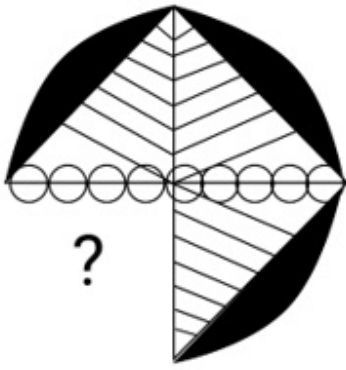

Ans

1.



2.



3.



4.



Q.9 Six letters, P, Q, R, S, T and U, are written on the different faces of a dice. Two positions of this dice are shown in the given figure. Find the letter on the face opposite to P.

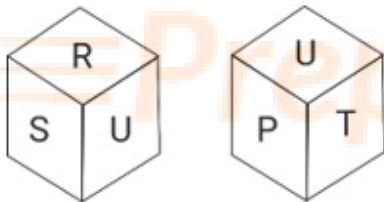

Ans 1. R

2. T

3. S

4. Q

Q.10 Which figure should replace the question mark (?) if the series were to be continued?

P	L	Z	P	P	Z	3	P	
	3		L		Y		Z	?
↑	Z		3	↑	↑	3	Y	↑

Ans

✓ 1.

P	3
	8
↑	Y

✗ 2.

↑	Y
	8
	P
	3

✗ 3.

P	Y
	3
↑	Z

✗ 4.

↑	Y
	3
	P
	Z

Q.11 Which of the following option figures will complete the pattern in the figure given below?



Ans

- 1.
- 2.
- 3.
- 4.

Q.12 If 'A' denotes '+', 'B' denotes '×', 'C' denotes '-' and 'D' denotes '÷', then what will come in place of '?' in the following equation?
55 C 5 A 40 B 2 A 320 D 4 = ?

- 1. 210
- 2. 50
- 3. 20
- 4. 100

Q.13 Three different positions of the same dice are shown. Find the number on the face opposite the face showing '6'.

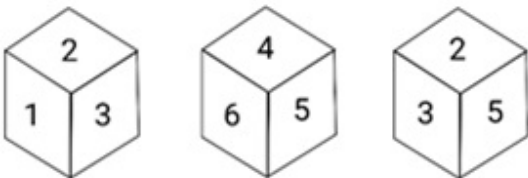

- 1. 1
- 2. 3
- 3. 4
- 4. 5

Q.14 In a certain code language, 'north by west' is coded as 'times are hard', 'east by south' is coded as 'had good time west axis' is coded as 'had hard try', and 'north axis' is coded as 'try are'. What is the code for the word 'north'?

- Ans
- 1. south
 - 2. try
 - 3. are
 - 4. east

Q.15 Select the correct mirror image of the given figure when the mirror is placed at PQ as shown below.



- Ans
- 1. \$#@!#\%08εΣ#?
 - 2. \$#@!#\%08Σε#?
 - 3. \$#@!\%#08Σε#?
 - 4. \$#@!#\%80εΣ#?

Q.16 Which two signs should be interchanged to make the following equation correct?

$$16 \div 2 + 54 - 3 \times 2 = 50$$

- Ans
- 1. - and +
 - 2. + and -
 - 3. + and ×
 - 4. - and ×

Q.17 Select the option that is related to the third term in the same way as the second term is related to the first term and the sixth term is related to the fifth term.
54 : 162 :: 26 : ? :: 88 : 264

- Ans
- 1. 74
 - 2. 78
 - 3. 72
 - 4. 76

Q.18 How many triangles are there in the given figure?

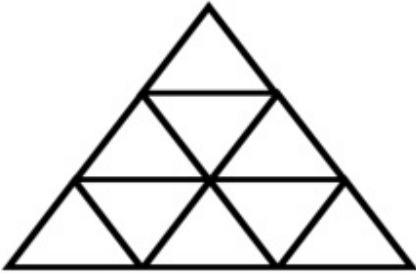

- Ans
- 1. 10
 - 2. 12
 - 3. 11
 - 4. 13

Q.19 A dice with 6 faces is marked with 6 alphabets A, B, C, D, E and F, respectively. It is rolled 3 times and lands on the positions shown below. Which alphabet is on the opposite plane of B?

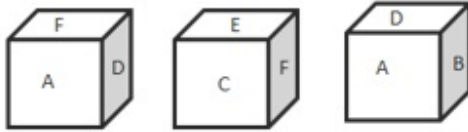

- Ans
- 1. F
 - 2. E
 - 3. C
 - 4. D

Q.20 Select the number from among the given options that can replace the question mark (?) in the following series.

3, 4, 6, 10, 18, ?

- Ans
- 1. 21
 - 2. 34
 - 3. 53
 - 4. 56

Prepare 50% Faster

Q.21 A square sheet of paper is folded along the dotted line successively along the directions shown and is then punched last. How would the paper look when unfolded?

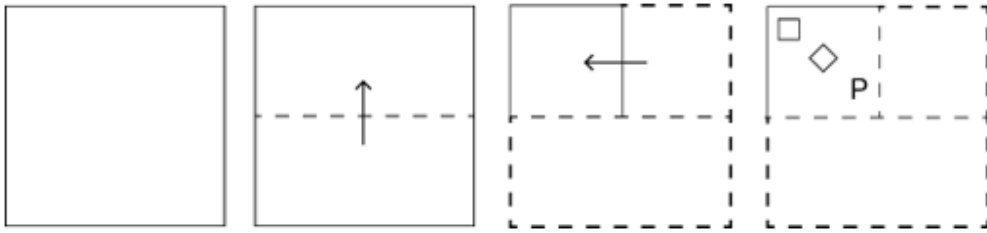

Ans

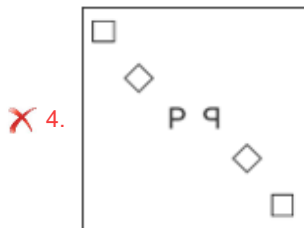
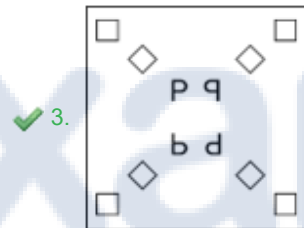
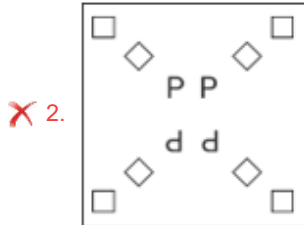
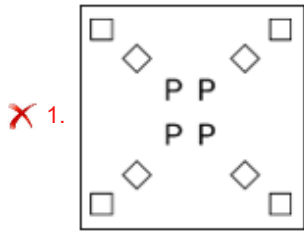

Q.22 Select the set in which the numbers are related in the same way as are the numbers of the following sets.
(NOTE: Operations should be performed on the whole numbers, without breaking down the numbers into its constituent digits. E.g. 13 – Operations on 13 such as adding/deleting/multiplying etc. to 13 can be performed. Breaking down 13 into 1 and 3 and then performing mathematical operations on 1 and 3 is not allowed)
(5, 7, 17)
(7, 13, 29)

- Ans
- ✗ 1. (4, 11, 19)
 - ✓ 2. (9, 15, 33)
 - ✗ 3. (11, 25, 53)
 - ✗ 4. (15, 27, 51)

Q.23 Which of the following letter clusters will replace the question mark (?) in the given series to make it logically complete?
NOM, KMP, HKS, EIV, ?

- Ans
- ✗ 1. CGX
 - ✗ 2. BHY
 - ✓ 3. BGY
 - ✗ 4. BGX

Q.24 Rupin, Sunny, Guddu, Shradha, Naveen and Rahul are sitting around a circular table facing each other and sitting to each other. Rupin is between Naveen and Rahul. Naveen is opposite Shradha. Guddu is not the immediate neighbor of Naveen. Who is opposite to Sunny?

- Ans
- 1. Shradha
 - 2. Rupin
 - 3. Rahul
 - 4. Guddu

Q.25 Select the figure that will come next in the following figure series.



- Ans
- 1.
 - 2.
 - 3.
 - 4.

Section : Numerical Ability

Q.1 By selling 90 pens, a shopkeeper gains the selling price of 30 pens. What is his gain percentage?

- Ans
- 1. 70%
 - 2. 50%
 - 3. 40%
 - 4. 60%

Q.2 What is the compound interest on ₹3,90,625 in 2 years at 8% per annum compounded half-yearly?

- Ans
- 1. ₹66,351
 - 2. ₹66,350
 - 3. ₹66,348
 - 4. ₹66,345

Q.3 The value of $\frac{(231 + 19)^2 + (231 - 19)^2}{(231 \times 231 + 19 \times 19)}$ is:

- Ans
- 1. 62500
 - 2. 212
 - 3. 2
 - 4. 250

Q.4 The edges of a triangular board are 12 m, 35 m and 37 m. Find the cost of painting it at the rate of ₹ 8/m².

- Ans
- 1. ₹1,575
 - 2. ₹1,560
 - 3. ₹1,680
 - 4. ₹1,670

Q.5 A car dealer offers a 15% discount on a car marked at ₹5,00,000, while another dealer gives a discount of 12% on the first ₹3,00,000 and 6% on the next ₹2,00,000 on the same car along with accessories worth ₹6,000 as gift to his customers. What is the difference between the selling prices (in ₹) offered by the two car dealers?

- Ans
- 1. 21,000
 - 2. 33,000
 - 3. 27,000
 - 4. 39,000

Q.6 The salary of an employee is first increased by 45% and then it is decreased by 45%. What is the effective change in his salary?

- Ans
- 1. 20.25% increase
 - 2. 22.50% increase
 - 3. 20.25% decrease
 - 4. 22.50% decrease

Q.7 A garrison of 1200 men has provisions for 15 days. How long will the provisions last if the garrison is increased by 1800 men?

- Ans
- 1. 9 days
 - 2. 12 days
 - 3. 10 days
 - 4. 6 days

Q.8 The LCM of two co-prime numbers is 667 and one of the numbers is 23. What is the other number?

- Ans
- 1. 19
 - 2. 31
 - 3. 25
 - 4. 29

Q.9 A certain sum doubles in 5 years at simple interest. The same sum under the same interest rate will become six times in:

- Ans
- 1. 25 years
 - 2. 21 years
 - 3. 24 years
 - 4. 27 years

Q.10 There are five prime numbers written in ascending order. The product of the first four is 6545 and that of the last four is 24871. What is the last prime number?

- Ans
- 1. 19
 - 2. 17
 - 3. 23
 - 4. 29

Q.11 Find the total surface area of a solid right circular cylinder whose radius and height are 7 cm and 12 cm, respectively. (Use $\pi = \frac{22}{7}$)

- Ans
- 1. 836 cm²
 - 2. 814 cm²
 - 3. 720 cm²
 - 4. 782 cm²

Q.12 In a certain examination, Prabhu and Raghu secured marks in the ratio of 7 : 8. Whereas Raghu and Raghav secured marks in the ratio of 5 : 4. Find the ratio of the marks obtained by Prabhu and Raghav.

- Ans
- 1. 39 : 35
 - 2. 35 : 32
 - 3. 35 : 39
 - 4. 32 : 35

Q.13 What percentage decrease in salaries would exactly cancel out a 30% increase?

- Ans
- 1. $21\frac{2}{13}\%$
 - 2. $22\frac{2}{13}\%$
 - 3. $24\frac{1}{13}\%$
 - 4. $23\frac{1}{13}\%$

Q.14 Devender leaves his home every day at 8:25 A.M. and reaches the office at 9: 55 A.M. One day he left his home at 8:25 A.M. but travelled $\frac{3}{10}$ of the distance at $\frac{6}{7}$ of the usual speed and the rest of the distance at $\frac{7}{6}$ of the usual speed. At what time did Devender reach the office on that day?

- Ans
- 1. 9:50:40 A.M.
 - 2. 9:50:50 A.M.
 - 3. 9:50:30 A.M.
 - 4. 9:50:20 A.M.

Q.15 What is the average of 1, 2, 4, 5, 6, 9, 11 and 18?

- Ans
- 1. 8
 - 2. 6
 - 3. 9
 - 4. 7

Section : Computer Proficiency

Q.1 Which of the following keyboard shortcuts is used to open a new, blank document in Microsoft Word 365?

- Ans
- 1. Ctrl + P
 - 2. Ctrl + S
 - 3. Ctrl + O
 - 4. Ctrl + N

Q.2 In MS Excel 365 which of the following is the correct sequence for inserting a row above a given row in MS-Excel spreadsheet?

- Ans**
- 1. Select the cell<<Left click<<Insert<<Entire Column
 - 2. Select the cell<<Right click<<Insert<<Entire Column
 - 3. Select the cell<<Right click<<Insert<<Entire Row
 - 4. Select the cell<<Left click<<Insert<<Entire Row

Q.3 In MS Excel 365, Which feature in Microsoft Excel is used to visually represent data through graphical representation?

- Ans**
- 1. PivotTable
 - 2. Charts
 - 3. Macro
 - 4. Formula

Q.4 What is the file extension to save a document in MS Word 2003?

- Ans**
- 1. .docx
 - 2. .xls
 - 3. .odt
 - 4. .doc

Q.5 Which of the following options within the Table group of the Insert tab is used to place a table in an MS Word 365 document?

- Ans**
- 1. Cut
 - 2. Paste
 - 3. Table
 - 4. Copy

Q.6 What is the purpose of applying shading to a table in Microsoft Word 365?

- Ans**
- 1. To sort the data in the table
 - 2. To adjust the column widths in the table
 - 3. To highlight specific cells or rows in the table
 - 4. To change the font colour within the table

Q.7 Which of the following statements related to addressing of cells in MS Excel is INCORRECT?

- Ans**
- 1. The cell in the first column and first row is A1.
 - 2. The cell in the second column and third row is B3.
 - 3. Rows in MS Excel are identified by numbers.
 - 4. Columns in MS Excel are identified by numbers.

Q.8 What is the purpose of the CC field in an email?

- Ans**
- 1. It stands for 'Carbon Copy' and is used to include additional recipients who should be informed about the email.
 - 2. It stands for 'Copy Contents' and is used to copy and paste text into the email.
 - 3. It stands for 'Courtesy Copy' and is used to send a polite message along with the email.
 - 4. It stands for 'Closed Captioning' and is used to add subtitles to the email.

Q.9 What is one of the purpose of 'Print Preview' in formatting MS Word 365 documents?

- Ans**
- 1. To adjust page layout and formatting before printing
 - 2. To create a digital backup of the document
 - 3. To automatically correct spelling and grammar errors
 - 4. To convert the document to a different file format

Q.10 Which of the following is the correct full form of VOIP?

- Ans
- 1. Voice of intranet protocol
 - 2. Voice over intranet protocol
 - 3. Voice over internet protocol
 - 4. Volume over internet protocol



Prepare 50% Faster

Constable Executive Male and Female in Delhi Police Examination 2023

Exam Date	03/12/2023
Exam Time	3:00 PM - 4:30 PM
Subject	Constable Executive Male and Female in Delhi Police Examination 2023

Section : General Knowledge

Q.1 Indian Foreign Services and Indian Revenue Services come under which type of Civil Service?

- Ans**
- 1. Federal services
 - 2. State services
 - 3. Multinational services
 - 4. Central services

Q.2 _____ originated in Kerala.

- Ans**
- 1. Kuchipudi
 - 2. Kathakali
 - 3. Sattriya
 - 4. Bharatnatyam

Q.3 The term 'secular' was added to the Preamble of the Constitution of India by the 42nd Constitutional Amendment Act in the year _____.

- Ans**
- 1. 1975
 - 2. 1974
 - 3. 1978
 - 4. 1976

Q.4 Har Ghar Tiranga campaign was launched for which of the following national day celebrations?

- Ans**
- 1. Gandhi Jayanti
 - 2. Children's Day
 - 3. Republic Day
 - 4. Independence Day

Q.5 As per Human Development Report 2021-22, what is the percentage of population under severe multi-dimensional poverty?

- Ans**
- 1. 51.3%
 - 2. 31.3%
 - 3. 41.3%
 - 4. 8.8%

Q.6 'A Passage to India', a novel about the British Empire, was written by which of the following authors?

- Ans**
- 1. Sinclair Lewis
 - 2. EM Forster
 - 3. James Joyce
 - 4. Anita Loos

Q.7 Which Act of the Government of India ensures the 'right to work' from the following?

- Ans
- 1. Mahatma Gandhi National Rural Employment Guarantee Act
 - 2. Indian Institutes of Management Act
 - 3. The Employees' Provident Funds and Miscellaneous Provisions Act
 - 4. Citizenship Act

Q.8 Which of the following was/were the limitation(s) of the Green Revolution?

- A. Confined to limited crops
B. Uneven spread

- Ans
- 1. Both A and B
 - 2. Neither A nor B
 - 3. Only A
 - 4. Only B

Q.9 Which genus of the Rhodophyceae family possesses an erect series of branches and a filamentous prostrate section attached to the substratum by means of unicellular rhizoids?

- Ans
- 1. Sargassum
 - 2. Dictyota
 - 3. Laminaria
 - 4. Polysiphonia

Q.10 Who among the following was NOT a gold medallist at the Commonwealth Games-2022?

- Ans
- 1. Ravi Dahiya
 - 2. Vinesh Phogat
 - 3. Pooja Gehlot
 - 4. Naveen Kumar

Q.11 U Srinivas is associated with which musical instrument?

- Ans
- 1. Kanjra
 - 2. Shehnai
 - 3. Mandolin
 - 4. Violin

Q.12 'Files and Ranks' are used in which of the following games?

- Ans
- 1. Badminton
 - 2. Cricket
 - 3. Hockey
 - 4. Chess

Q.13 The Swaran Singh Committee had suggested the incorporation of a total of _____ Fundamental Duties.

- Ans
- 1. 13
 - 2. 14
 - 3. 8
 - 4. 10

Q.14 Which of the following economic reforms were initiated by the government under their liberalisation policy?

- Ans
- 1. Industrial and agricultural sector reforms
 - 2. Industrial, agricultural and financial sector reforms
 - 3. Agricultural and financial sector reforms
 - 4. Industrial and financial sector reforms

Q.15 International Day of Non-violence is marked on which of the following freedom fighter's birth anniversary?

- Ans**
- 1. Lal Bahadur Shastri
 - 2. BR Ambedkar
 - 3. Jawaharlal Nehru
 - 4. Mahatma Gandhi

Q.16 Carbonated beverages contain _____.

- Ans**
- 1. CO₂
 - 2. N₂
 - 3. O₂
 - 4. CH₄

Q.17 In which of the following sessions of the Indian National Congress was the demand for 'Swaraj' put forward for the first time?

- Ans**
- 1. Karachi
 - 2. Calcutta
 - 3. Bankipur
 - 4. Bombay

Q.18 Which type of title can be conferred by the state as per Article 18 of the Constitution of India?

- Ans**
- 1. Military and Academic
 - 2. Military and Social
 - 3. Religious and Music
 - 4. Sports and Music

Q.19 The ICAR-Central Institute for Cotton Research is located in _____.

- Ans**
- 1. Hyderabad
 - 2. Jaipur
 - 3. Bhopal
 - 4. Nagpur

Q.20 Matthew Hayden, former Australian cricketer, has written which of the following autobiographies?

- Ans**
- 1. The Test of My Life
 - 2. Playing it My Way
 - 3. Standing My Ground
 - 4. At the Close Play

Q.21 The terms, 'Aus', 'Aman' and 'Boro', are associated with which crop in West Bengal?

- Ans**
- 1. Tea
 - 2. Wheat
 - 3. Maize
 - 4. Rice

Q.22 Up to which financial year has the 'New India Literacy Programme' been launched to impart foundational literacy and numeracy, critical life skills, vocational skills, basic and continuing education?

- Ans**
- 1. FY 2027
 - 2. FY 2026
 - 3. FY 2029
 - 4. FY 2025

Q.23 Which of the following soil varieties is favourable for the growth of mangroves and deltaic vegetation?

- Ans
- 1. Desert soil
 - 2. Fine clay and alluvial soil
 - 3. Laterite soil
 - 4. Black soil

Q.24 Uraiyur, a place famous for cotton, was the political centre (capital) of the:

- Ans
- 1. Cholas
 - 2. Cheras
 - 3. Chalukyas
 - 4. Pandyas

Q.25 निम्नलिखित में से कौन-सा विघटन के अधीन नहीं है?

- Ans
- 1. विधान-परिषद
 - 2. मंत्रिमंडल
 - 3. विधानसभा
 - 4. मंत्री-परिषद

Q.26 Consider the following groups of elements:

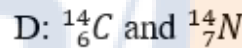
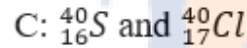
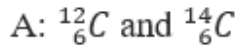

Which of the following identifications regarding the given groups is correct?

- Ans
- 1. Isotopes: A and D
Isobars: B and C
 - 2. Isotopes: A and B
Isobars: C and D
 - 3. Isotopes: C and D
Isobars: A and B
 - 4. Isotopes: A and C
Isobars: B and D

Q.27 Mauryan emperor Ashoka conquered Kalinga, which is currently known as _____.

- Ans
- 1. Bengal
 - 2. Bihar
 - 3. Uttar Pradesh
 - 4. Odisha

Q.28 The mob-burning of a police station in Chauri Chaura in 1922 brought about the end of the Non-Cooperation Movement. In which present-day state is Chauri Chaura located?

- Ans
- 1. Uttar Pradesh
 - 2. Bihar
 - 3. Punjab
 - 4. Haryana

Q.29 As of October 2022, which of the following is a Stupa site excavated in the state of Karnataka?

- Ans
- 1. Amravati
 - 2. Sannati
 - 3. Sanchi
 - 4. Guntapalle

Q.30 What is the full form of 'ICC'?

- Ans
- 1. International Cricket Council
 - 2. Indian Cricket Council
 - 3. Internal Cricket Committee
 - 4. International Committee for Cricket

Q.31 Pandit Ajoy Chakrabarty, who was conferred with Padma Bhushan in 2020, is a veteran vocalist of the _____ Gharana.

- Ans
- 1. Rangeela
 - 2. Patiala
 - 3. Gwalior
 - 4. Kirana

Q.32 Name the first Indian woman who became the President of the Indian National Congress.

- Ans
- 1. Sarala Devi Chaudhurani
 - 2. Annie Besant
 - 3. Sarojini Naidu
 - 4. Rani Velu Nachiyar

Q.33 A court poet of the Gupta period, Harishena, wrote a glowing account of the military exploits of his patron. Who was his patron?

- Ans
- 1. Chandragupta II
 - 2. Chandragupta I
 - 3. Samudragupta
 - 4. Kumaragupta I

Q.34 What was the approximate overall growth target in India's First Five-Year Plan?

- Ans
- 1. 2.1%
 - 2. 1.3%
 - 3. 3.5%
 - 4. 4.2%

Q.35 During the Mughal period, what were the farmers called who cultivate their own land?

- Ans
- 1. Muzarain
 - 2. Pahi Kasht
 - 3. Khud kashta
 - 4. Zamindar

Q.36 WACA Cricket Ground is located in _____.

- Ans
- 1. Perth
 - 2. Sydney
 - 3. London
 - 4. Mumbai

Q.37 As per data released by Centre for Monitoring Indian Economy (CMIE) for the month of December 2022, _____ recorded the lowest unemployment at 0.9%.

- Ans
- 1. Haryana
 - 2. Rajasthan
 - 3. Odisha
 - 4. Madhya Pradesh

Q.38 Which Governor General built the Victoria Memorial in Kolkata in 1905 in the memory of Queen Victoria of Britain

- Ans**
- 1. Lord Ripen
 - 2. Lord Canning
 - 3. Lord Curzon
 - 4. Lord Bentinck

Q.39 Which substance is fortified with calcium, Vitamin D and Vitamin B12?

- Ans**
- 1. Eggs
 - 2. Cow's milk
 - 3. Dark green leafy vegetables
 - 4. Soy milk

Q.40 Which statement gives the details of the estimated revenue and expenditure of the government?

- Ans**
- 1. Balance of payments
 - 2. Balance sheet
 - 3. Annual financial statement
 - 4. Income statement

Q.41 Which Article of the Constitution of India consists of the provision for the establishment of the Finance Commission?

- Ans**
- 1. Article 270
 - 2. Article 260
 - 3. Article 280
 - 4. Article 250

Q.42 Select the correct statement.

- Ans**
- 1. The climate of the Northern Himalaya region is very hot and humid.
 - 2. In the Thar desert, the temperature difference is quite low between summers and winters.
 - 3. In the Southern peninsular region, the temperature difference is quite low between summers and winters.
 - 4. The climate of Gangetic plains is very stable throughout the year.

Q.43 Tippi is a well-known dance of which of the following states?

- Ans**
- 1. Gujarat
 - 2. Rajasthan
 - 3. Punjab
 - 4. Madhya Pradesh

Q.44 Where is the headquarter of the WTO located?

- Ans**
- 1. New York
 - 2. Rome
 - 3. Geneva
 - 4. Washington, D.C.

Q.45 Prarthana Samaj was established at Bombay in the year _____.

- Ans**
- 1. 1737
 - 2. 1937
 - 3. 1867
 - 4. 1537

Q.46 Which of the following is NOT a feature of Fundamental Duties?

- Ans
- 1. They emphasize on respecting Indian culture.
 - 2. They are justiciable.
 - 3. They are not applicable to foreigners.
 - 4. They are both, civic and moral in nature.

Q.47 वायुमंडल का सामान्य परिसंचरण क्या है?

- Ans
- 1. पृष्ठीय पवन के संचलन का पैटर्न
 - 2. जल के संचलन का पैटर्न
 - 3. ऊर्जा के संचलन का पैटर्न
 - 4. भूमंडलीय पवन के संचलन का पैटर्न

Q.48 A pilot project of linking Self-Help-Groups with banks was launched by NABARD. The success of the pilot project resulted in the introduction of three radical innovations by RBI/NABARD. Which of the following is NOT one of them?

- Ans
- 1. Acceptance of informal groups as clients of banks – both, for savings and credit linkage
 - 2. Avoidance of action in the event of defaults
 - 3. Introduction of collateral-free lending
 - 4. Permission to lend to groups without specification of purpose/activity/project

Q.49 What is the name for the gestures used in Bharatnatyam?

- Ans
- 1. Tripatakas
 - 2. Laya
 - 3. Mudras
 - 4. Gatakas

Q.50 Who among the following personalities is associated with Odissi dance?

- Ans
- 1. Jatin Goswami
 - 2. Yamini Krishnamurthy
 - 3. Ishira Parikh
 - 4. Surupa Sen

Section : Reasoning

Prepare 50% Faster

Q.1 Select the option in which the given figure is embedded (rotation is NOT allowed).

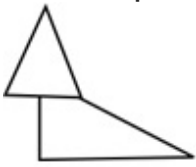

Ans

✓ 1.

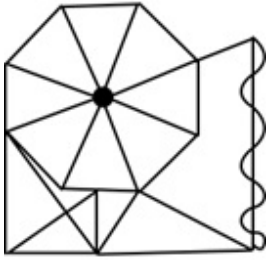

✗ 2.

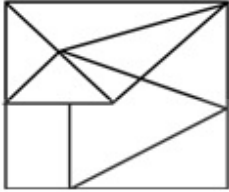

✗ 3.

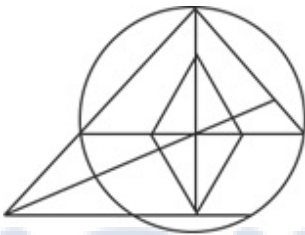

✗ 4.

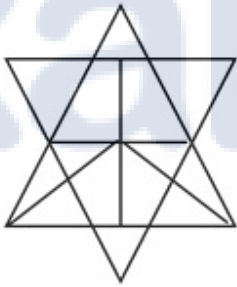

Q.2 Select the correct mirror image of the given combination when the mirror is placed at 'PQ' as shown below.



Ans

✓ 1.



✗ 2.



✗ 3.

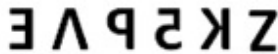

✗ 4.

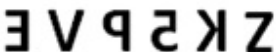

Q.3 Read the given statements and conclusions carefully. Assuming that the information given in the statements is true and it appears to be at variance with commonly known facts, decide which of the given conclusions logically follow(s) from the statements.

Statements:

All mangoes are grapes.

All grapes are guavas.

Conclusions:

I. All guavas are grapes.

II. All grapes are mangoes.

- Ans**
- 1. Neither conclusion I nor II follows
 - 2. Only conclusion I follows
 - 3. Both conclusions I and II follow
 - 4. Only conclusion II follows

Q.4 Which of the following terms will replace the question mark (?) in the given series?
ZOJ, XMH, VKF, ?, RGB

- Ans**
- 1. TEP
 - 2. TED
 - 3. DIT
 - 4. TID

Q.5 Select the correct mirror image of the given figure when the mirror is placed at MN as shown below.

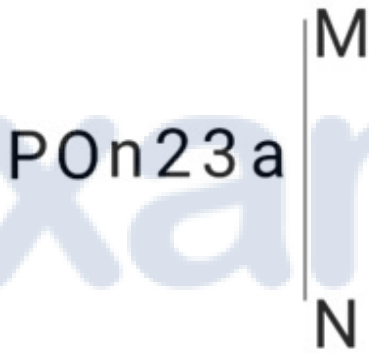

- Ans**
- 1. ɹ ɛ 2 n 0 P
 - 2. ɹ ɛ ɹ n 0 ɹ
 - 3. ɹ 3 ɹ n 0 ɹ
 - 4. ɹ ɛ ɹ n 0 ɹ

Q.6 Which figure should replace the question mark (?) if the following series were to be continued?

L U X Z Y	U ♡ T ↑ Z	Z U ♡ T ↑	U Y P L T	T U Y P L	?
♡ ↑	L Y	Y L	Z ↑	↑ ↑	

Ans

✗ 1. L T U Y P
Z ↑

✓ 2. U ↑ 3 Z P
T L

✗ 3. U ↑ Y Z P
T L

✗ 4. L P U Y Z
T ↑

Q.7

Which of the following option figures will complete the pattern in the figure given below?



Ans

✗ 1.



✗ 2.



✗ 3.



✓ 4.



Q.8

How many triangles are there in the given figure?

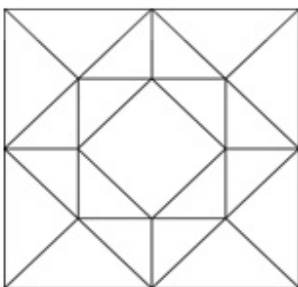

Ans

✓ 1. 28

✗ 2. 22

✗ 3. 30

✗ 4. 20

Q.9 Select the correct combination of mathematical signs that can sequentially replace the * signs and balance the given equation.

$$25 * 15 * 5 * 4 * 16 * 21$$

- Ans
- 1. +, -, ×, ÷, =
 - 2. +, ÷, ×, -, =
 - 3. +, ×, -, =, ÷
 - 4. ÷, -, ×, +, =

Q.10 Select the option in which the given figure is embedded (rotation is NOT allowed).

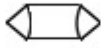

Ans

1.

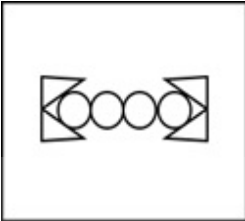

2.

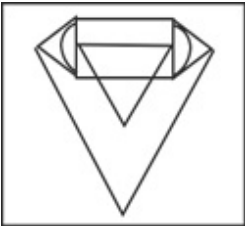

3.

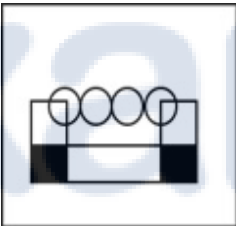

4.

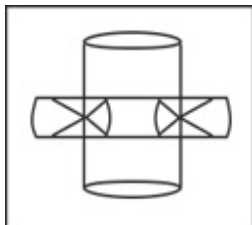

Q.11

Select the option in which the given figure is embedded (rotation is NOT allowed).

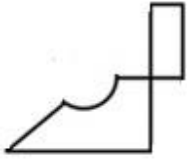

Ans

X 1.

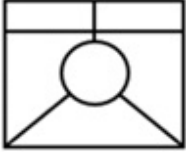

X 2.

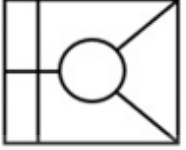

✓ 3.

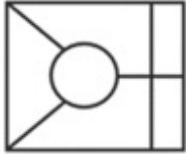

X 4.

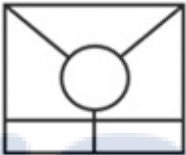

Prepare 50% Faster

Q.12 Select the correct mirror image of the given combination when the mirror is placed at 'MN' as shown below.

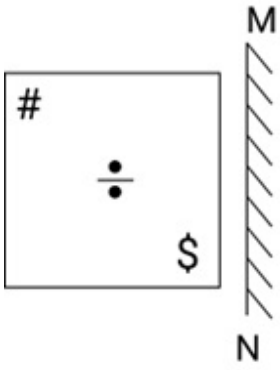

Ans

✗ 1.

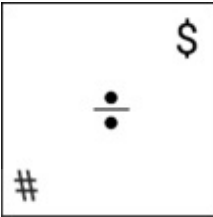

✗ 2.

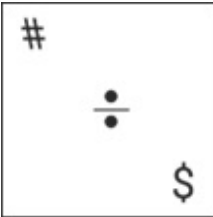

✓ 3.

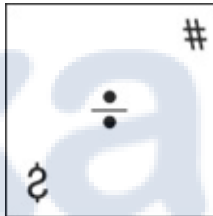

✗ 4.

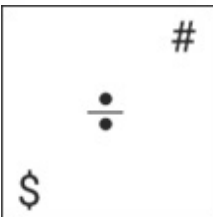

Q.13 If 'A' denotes '+', 'B' denotes 'x', 'C' denotes '-' and 'D' denotes '÷', then what will come in place of '?' in the following equation?
(21 B 3) C 33 D ? = 60

Ans ✗ 1. 30

✗ 2. 3

✓ 3. 11

✗ 4. 13

Q.14 Select the figure from the options that can replace the question mark (?) and complete the given pattern.

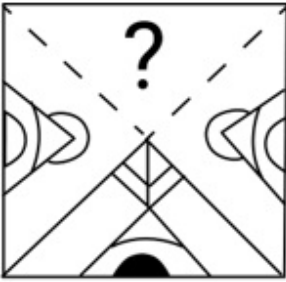

Ans

X 1.

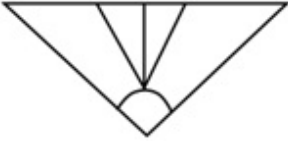

✓ 2.



X 3.



X 4.

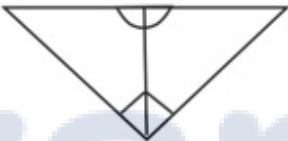

Prepare 50% Faster

Q.15 Select the option figure which is embedded in the given figure. (Rotation is NOT a)  Prepare 50% Faster

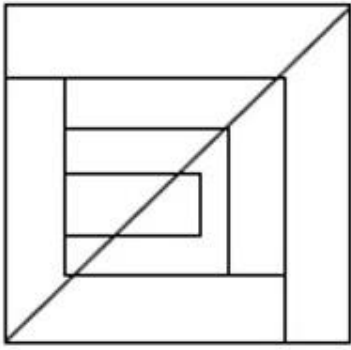

Ans

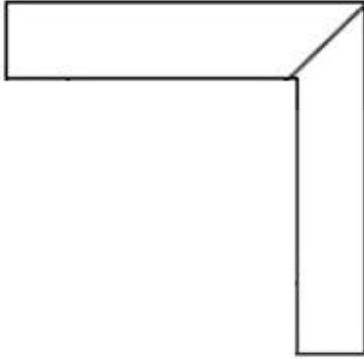

✓ 1.



✗ 2.

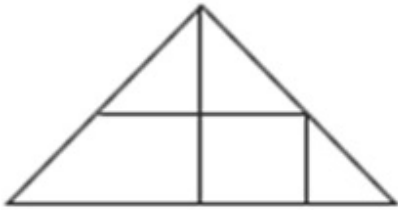

✗ 3.

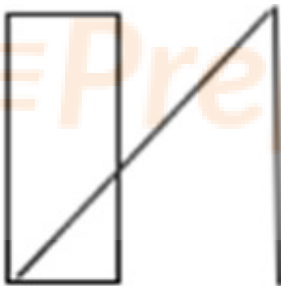

✗ 4.

Q.20 Select the number from among the given options that can replace the question mark (?) in the following series.

2, 9, 30, 93, 282, ?

- Ans
- 1. 423
 - 2. 467
 - 3. 849
 - 4. 343

Q.21 Select the option figure that is embedded in the given figure. (Rotation is not allowed).

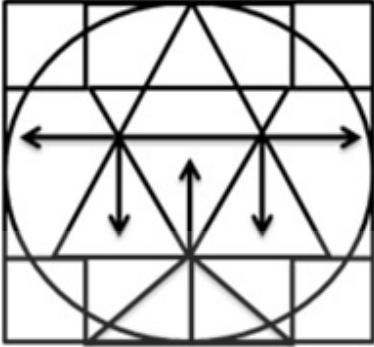

Ans

1.

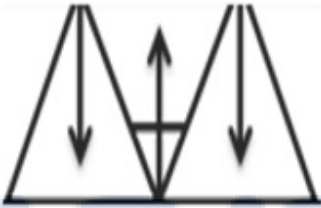

2.

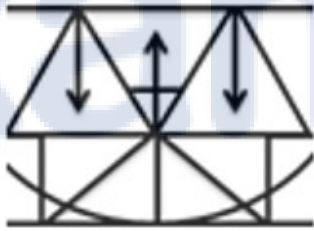

3.

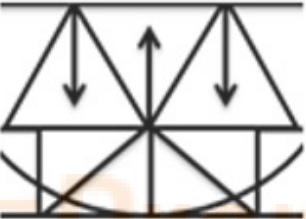

4.

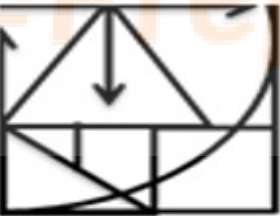

Q.22 P, Q, R, S, T, U and V are sitting in a straight row, facing north. V sits at the immediate left of P. U sits at the immediate right of Q. Only R sits between S and T. Only two persons sit to the right of S. P is to the immediate left of T. Who among the following is at the extreme right end of the row?

- Ans
- 1. S
 - 2. U
 - 3. V
 - 4. T

Q.23 Which figure should replace the question mark (?) in the following series to continue the pattern?

T	U	S	U	T	7	K	7	T	7	K	S	
	K			S			U			T		?
6		7	K		6	6		S	U		6	

Ans

1.

U	T	7
	K	
6		S

2.

S	7	K
	U	
6		T

3.

K	S	T
	7	
6		U

4.

U	S	K
	7	
6		T

Q.24 Select the option that is related to the fourth term in the same way as the first term is related to the second term and the fifth term is related to the sixth term.

11 : 343 :: ? : 125 :: 7 : 27

Ans 1. 11

2. 10

3. 13

4. 9

Q.25 Select the option figure that will replace the question mark (?) in the figure given below to complete the pattern.



Ans

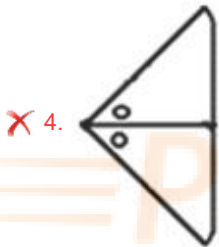
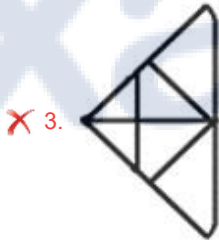
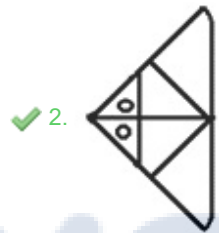
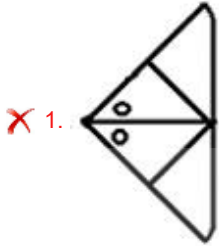

Section : Numerical Ability

Q.1 If Basket A has 9 apples and 12 bananas, Basket B has 10 apples and 15 bananas, and Basket C has 8 apples and 16 bananas, then the ratios of apples and bananas in _____.

- Ans
- ✗ 1. Basket A < Basket B
 - ✗ 2. Basket A < Basket C
 - ✓ 3. Basket A > Basket B
 - ✗ 4. Basket A = Basket C

Q.2 Simplify $\left[\left(\left(2\frac{5}{13} \right) \% \text{ of } 9100 + \left(1\frac{1}{17} \right) \% \text{ of } 10200 \right) + \frac{3}{5}(17 + 13) \right]^{\frac{1}{3}}$.

- Ans
- ✗ 1. 11
 - ✗ 2. 9
 - ✓ 3. 7
 - ✗ 4. 14

Q.3 For reaching at a dance class, Neelam walks at 5 km/h and reaches late by 10 min. If she increases her speed by then she reaches 15 min early. Find the distance she travelled from her house to her destination.

- Ans**
- 1. 10.5 km
 - 2. 12.5 km
 - 3. 10 km
 - 4. 5.5 km

Q.4 Find the greatest common divisor of 65, 75 and 90.

- Ans**
- 1. 15
 - 2. 13
 - 3. 3
 - 4. 5

Q.5 Shashi sold her washing machine for ₹8,000; this was 60% increase in the value. What was the original price?

- Ans**
- 1. ₹5,000
 - 2. ₹6,200
 - 3. ₹5,400
 - 4. ₹5,800

Q.6 Find the area (in cm^2) of the triangle whose height is 48 cm and the base is $\frac{1}{6}$ the length of the height?

- Ans**
- 1. 188
 - 2. 192
 - 3. 190
 - 4. 174

Q.7 A conical tent is required to accommodate 3 persons and each person needs 45 m^2 of space on the ground and 300 m^3 of air to breath. Find the vertical height of the tent (in m).

(Take $\pi = \frac{22}{7}$)

- Ans**
- 1. 20
 - 2. 18
 - 3. 25
 - 4. 30

Q.8 3 men and 4 women can do a work in 7 days, whereas 2 men and 1 woman can do it in 14 days. 7 women will complete the same work in:

- Ans**
- 1. 8 days
 - 2. 12 days
 - 3. 10 days
 - 4. 9 days

Q.9 In how much time (in years) will a sum of ₹3,125 become ₹3,515.20 at 8% per annum, compounded half-yearly?

- Ans
- 1. $2\frac{1}{2}$
 - 2. 2
 - 3. 3
 - 4. $1\frac{1}{2}$

Q.10 If the cost price and selling price of an article are in the ratio of 13 : 17, then the percentage profit is:

- Ans
- 1. $30\frac{11}{13}\%$
 - 2. $30\frac{10}{13}\%$
 - 3. $30\frac{7}{13}\%$
 - 4. $30\frac{8}{13}\%$

Q.11 In an election, there were two candidates Ram and Soham. The total number of voters in this constituency was 85800 and 80% of the total votes were polled. If 65% of the polled votes were cast in favour of Soham, how many votes were received by Ram?

- Ans
- 1. 24024
 - 2. 26026
 - 3. 34034
 - 4. 38038

Q.12 The marked price of a commodity was ₹3,675. The seller offered a discount of 12% on its sale and incurred a loss of 2% as a consequence. What was the cost price (in ₹) of the commodity?

- Ans
- 1. 3300
 - 2. 3280
 - 3. 3350
 - 4. 3275

Q.13 Find the average of all prime numbers between 15 and 30.

- Ans
- 1. 24
 - 2. 22
 - 3. 25
 - 4. 23

Q.14 Two banks, A and B, offered loans at rates 5.5% and 6.5% per annum, respectively. Ramesh borrowed an amount of ₹3,00,000 from each bank. The positive difference between the amounts of simple interest paid to the two banks by Ramesh after 2 years will be:

- Ans
- 1. ₹8,000
 - 2. ₹6,000
 - 3. ₹4,000
 - 4. ₹2,000

Q.15 The value of $\frac{0.2 \times 0.2 \times 0.2 + 0.5 \times 0.5 \times 0.5}{0.02 \times 0.02 \times 0.02 + 0.05 \times 0.05 \times 0.05}$ is:

- Ans
- 1. 5000
 - 2. 10000
 - 3. 100
 - 4. 1000

Section : Computer Proficiency

Q.1 Which of the following folders has an unsolicited and unwanted junk email sent out in bulk to an indiscriminate recipient list?

- Ans
- 1. Outbox
 - 2. Spam folder
 - 3. Inbox
 - 4. Draft

Q.2 Which of the following shortcut keys can be used to 'align right' the selected text in MS-Word 365?

- Ans
- 1. Ctrl + R
 - 2. Ctrl + U
 - 3. Ctrl + J
 - 4. Ctrl + E

Q.3 The shortcut key used to save the document in MS-Word 365 is:

- Ans
- 1. Ctrl + X
 - 2. Ctrl + A
 - 3. Ctrl + S
 - 4. Ctrl + V

Q.4 Which function is used to display the current date in MS-excel 365?

- Ans
- 1. MONTH()
 - 2. DATE()
 - 3. DAY()
 - 4. TODAY()

Q.5 In MS word 365 What does the 'Header' section in the 'Page Setup' dialog box allow you to do?

- Ans
- 1. Change the line spacing of the document
 - 2. Adjust the page margins
 - 3. Change the page orientation
 - 4. Add a header with text or page numbers to the top of each page

Q.6 Which of the following protocols is commonly used for sending and receiving emails between servers?

- Ans
- 1. Transmission Control Protocol (TCP)
 - 2. Simple Mail Transfer Protocol (SMTP)
 - 3. File Transfer Protocol (FTP)
 - 4. Hyper Text Transfer Protocol (HTTP)

Q.7 Which of the following keyboard shortcuts is used to apply bullets in MS Word 365?

- Ans
- 1. Ctrl + Shift + C
 - 2. Ctrl + Shift + L
 - 3. Ctrl + Shift + I
 - 4. Ctrl + Shift + B

Q.8 In Microsoft Excel 365, which of the following is NOT done by Conditional Formatting?

- Ans**
- 1. We can set condition to look for bold and apply italics on them.
 - 2. We can apply font border and pattern formats that meet the specified conditions.
 - 3. We can add more than one condition to format.
 - 4. We can delete condition if it is not required.

Q.9 What does the 'Grammar' check in Microsoft Word 365 primarily focus on?

- I. Spelling errors
- II. Sentence structure and syntax

- Ans**
- 1. Both I and II
 - 2. Only I
 - 3. Neither I nor II
 - 4. Only II

Q.10 In MS Excel 365, The basic syntax or symbol required to execute a function in MS-Excel is:

- Ans**
- 1. \$
 - 2. :
 - 3. +
 - 4. =



Prepare 50% Faster